



4.0

our ideas  
**at your fingertips**



innovation and technology  
in the Water Filtration Sector.  
Made in Italy.

generalcatalogue

# ATLAS FILTRI, A STEERING FORCE BEHIND THE WATER TREATMENT INDUSTRY

COMPANY WITH  
MANAGEMENT SYSTEM  
CERTIFIED BY DNV GL  
= ISO 9001 =  
= ISO 14001 =  
= OHSAS 18001 =



Atlas Filtri is a dynamic and flexible, modern manufacturing company: designing, developing and producing components and systems for water treatment applicable to both domestic and industrial sectors.

We are established since 1975 and being in the water filtration industry for over 40 years Atlas Filtri has created a name for itself in the world through constant dedication and attention to detail and innovation of products and materials...

**as well as the constant enthusiasm that identifies us!**

You will be able to find our production site and offices in Padua, located in the North Eastern part of Italy. Today Atlas Filtri consists in over 100 highly qualified staff with a corporate structure made up of 4 companies and 1 specialized division:

- **Atlas Filtri srl**, headquarter of the group and dealing with all the production and export of goods.
- **Atlas Filtri Italia srl**, the the distribution company for the Italian market and its specialized division Atlas Filtri Engineering dedicated to the production of water treatment systems for commercial and industrial use.

2016 marks the year that Atlas Filtri became international through the constitution of the companies:

- **Atlas Filtri North America LLC**, the distribution company with dedicated stock and assembly line for the North American market.
- **Atlas Filtri Far East Ltd**, the commercial office for the Asian market, with special attention to China.

As an Italian company, we are dedicated to engineering and designing our products in true Italian style, each of which is internationally patented. Our products are each uniquely styled to provide simplicity of use, reliability and versatility. We are very proud to declare that all of our products are 100% produced in Italy and so reflect the reputation that the Made in Italy has all over the world.

In fact, **the Made in Italy concept is the core value of our way of being.**



We are dedicated to following closely all the steps leading to the products realization. Starting from the innovative idea, our technicians design the product and prototype it. The realization of the mold then leads to a fully automatized production process with persistent quality control to ensure the highest-level products with the lowest levels of refuse. It is our responsibility to protect our world by keeping carbon emissions to a minimum and by producing as little waste a possible and our production strategy and material choice does precisely that.

**In Atlas Filtri we are committed to the constant pursuit of high performance and we achieve this by using the most innovative materials out there. In particular, we were the first in the industry to use PET as filter bowls. This is a highly innovative material which has low impact on the environment during the production process and at the same time ensures exceptionally high performance levels.**



We are a company certified ISO 9001:2008 (DNV) guaranteeing quality management standard throughout our company; UNI EN ISO 14001:2004 (DNV) Environmental System Certification; BS OHSAS 18001:2007 (DNV) Safety System Certification. The certification program includes of course the quality control of our products as well as our internal management system. In addition to this, our products are certified to meet this world's strictest standards.

With the mission of improving water quality worldwide offering products, services and expertise we participate as an active member of several world water organization.

We see every project as an opportunity and we are flexible in offering clients the most tailored service we can to meet their needs. From the first contact to the after sales service we are dedicated to standing by our clients. Atlas Filtri Academy is at the exclusive service of all our clients for training sessions and dedicated lessons to employees in order to transfer the tools and know-how on our products and services.

Our teams of Engineers or Sales Area Managers (depending on the topic of the training) are ready to fly all over the world to be at your service. Service and relationships are at the core of our business strategy and we are dedicated to protecting and helping our clients to grow to success.

We look forward to discussing more details with you and to welcoming you to one of our offices around the world. Please do not hesitate to contact us!

Daniele Costantini  
Vice-President of Atlas Filtri S.r.l.



ASSOCIATA



ASSOCIAZIONE COSTRUTTORI TRATTAMENTI ACQUE PRIMARIE

FEDERATA



# index

## PLUS FILTER HOUSINGS

PLUS 3P and 2P for cartridges SX .....	p. 5
PLUS 3P for cartridges BX and CX .....	p. 25
PLUS 3P SANIC with antimicrobial technology for cartridges SX and BX .....	p. 41
MIGNON PLUS for cartridges MIGNON SX .....	p. 51
MICRO 3/8" .....	p. 57

## SPECIAL FILTER HOUSINGS

PLUS HOT 3P for cartridges SX and BX .....	p. 59
3P PP for cartridges SX .....	p. 65
K DP for cartridges SX, BX and CX .....	p. 71
FX AF and XX with stainless steel tightening clamp .....	p. 77

## DP FILTER HOUSINGS

DP for cartridges SX and BX .....	p. 81
DP SANIC with antimicrobial technology for cartridges SX and BX .....	p. 101
DP DS with rotational connection group for cartridges SX and BX .....	p. 111

## DP BIG FILTER HOUSINGS

DP BIG .....	p. 117
DP BIG F .....	p. 135
DP BIG SANIC .....	p. 141
DP BIG F SANIC .....	p. 147

## SELF-CLEANING FILTERS

HYDRA self-cleaning filters .....	p. 153
HYDRA DS self-cleaning filters with rotational connection group .....	p. 165
HYDRA DUO and TRIO multi-stage self-cleaning filters .....	p. 169
HYDRA RAINMASTER multi-stage self-cleaning filters .....	p. 179
KIT AUTO for self-cleaning filters .....	p. 186

## DRINKING WATER UNITS

DEPURAL® .....	p. 190
DEPURAL® TOP .....	p. 192
DEPURAL® DP and DEPURAL® DP CASE .....	p. 196
BRAVO DP - BRAVO DP CASE .....	p. 200
IN LINE .....	p. 202
OASIS DP RO .....	p. 204
OASIS DP SANIC RO .....	p. 208

## SEDIMENT FILTER CARTRIDGES

FA polypropylene wound thread .....	p. 215
FA BIG polypropylene wound thread .....	p. 217
FA HOT polypropylene wound thread for hot water .....	p. 218
CPP melt-blown polypropylene .....	p. 219
CPP BIG melt-blown polypropylene .....	p. 223
PP melt-blown polypropylene .....	p. 224
GA quartzite block .....	p. 225
TS pleated polyester net .....	p. 226
TS BIG pleated polyester net .....	p. 227
CS pleated special paper .....	p. 228
CS BIG pleated special paper .....	p. 229
AB ceramic .....	p. 230
AC pleated polypropylene-borosilicate .....	p. 231
RL polyester washable net .....	p. 232
RL C polyester washable net .....	p. 233
RL A stainless steel washable net AISI 316 .....	p. 234
RA A stainless steel washable net AISI 316 .....	p. 235
RA C stainless steel washable net AISI 304 .....	p. 236
RA BIG stainless steel washable net AISI 304 - AISI 316 .....	p. 237
SA A stainless steel washable net AISI 316 .....	p. 238
SA C stainless steel washable net AISI 304 .....	p. 239
SA BIG stainless steel washable net AISI 304 - AISI 316 .....	p. 240
RS pleated polypropylene washable net .....	p. 241



## WATER TREATMENT FILTER CARTRIDGES

### SANIC FILTER CARTRIDGES WITH ANTIMICROBIAL TECHNOLOGY

FA SANIC polypropylene wound thread.....	p. 245
FA BIG SANIC polypropylene wound thread.....	p. 247
CPP SANIC melt-blown polypropylene.....	p. 248
CPP BIG SANIC melt-blown polypropylene.....	p. 250

### GRANULAR ACTIVATED CARBON

LA granular activated carbon (GAC).....	p. 253
FA CA wound polypropylene thread and granular activated carbon (GAC).....	p. 254
CA melt-blown polypropylene and granular activated carbon (GAC).....	p. 255
BT CPP LA melt-blown polypropylene and granular activated carbon (GAC).....	p. 256

### ACTIVATED CARBON BLOCK

CA SE SX carbon block.....	p. 257
CA SE BX carbon block.....	p. 258
CA-SE HF carbon block and hollow-fibre membranes.....	p. 259
CB-EC carbon block with outer protection sheet.....	p. 260
CB-EC BIG carbon block with outer protection sheet.....	p. 262

### POLYPHOSPHATE CRYSTALS

HA polyphosphate crystals.....	p. 263
BT CPP HA melt-blown polypropylene and polyphosphate crystals.....	p. 264
BT RL HA polyester washable net and polyphosphate crystals.....	p. 265
FA HA wound polypropylene thread and polyphosphate crystals.....	p. 266
CPP HA melt-blown polypropylene and polyphosphate crystals.....	p. 267

### IONIC EXCHANGE RESINS

QA CF strong cationic resin.....	p. 268
QA AF anionic resin.....	p. 269
QA LM mixed bed strong cationic and anionic resin.....	p. 270

### EMPTY CONTAINERS

P empty container.....	p. 271
------------------------	--------

## ANTI-SCALE SYSTEMS

ANTI-SCALE CONDITIONING.....	p. 272
DOSAPLUS proportional dosing systems with polyphosphate powder and with Poliphos.....	p. 275
DOSAPROP PLUS proportional dosing systems with polyphosphate crystals.....	p. 281
DOSAFOS PLUS non-proportional dosing systems with polyphosphate crystals.....	p. 289
DOSAL for washing machine.....	p. 298
MAG magnetic conditioners.....	p. 299

## WATER TREATMENT SYSTEMS

### TECHNO EQUIPMENTS

JUPITER softeners.....	p. 301
ADRIATIC 5 portable softener.....	p. 308
MEDIA FILTERS.....	p. 310
- MARS iron removers.....	p. 312
- VENUS chlorine removers.....	p. 313
- SAND quartzite filters.....	p. 314
- VEGA arsenic removers.....	p. 315

PRODUCTS FOR WATER TREATMENTS.....	p. 317
------------------------------------	--------

UV STERILIZERS.....	p. 319
---------------------	--------

RO Reverse Osmosis equipments.....	p. 323
------------------------------------	--------

## DRINKING WATER STANDARDS

.....	p. 331
-------	--------

## GENERAL INFORMATION

.....	p. 332
-------	--------



## PLUS 3P<sub>and</sub> 2P

filter housings for cartridges SX

Full range of housings designed to fit to standard SX (DOE) cartridges with height from 4" to 20".

# HOUSINGS PLUS 3P and 2P

FOR CARTRIDGES SX

## Housings PLUS SX fit to standard SX (DOE) cartridges.

The full range of Atlas Filtri® SX cartridges is suitable to PLUS SX housings and provide the widest range of water filtration and treatment units.



**SX** cartridges with standard flat seals.

The housings are made in 2 main versions:

- **3P** housings for cartridge height at 5", 7", 10", 20".
- **2P** housings for cartridge height at 4", 7", 10".

All 3P and 2P housings are available as single, DUPLEX and TRIPLEX models.

PLUS SX housings are suitable for every Point-of-Entry (POE) application, as single or multi-stage on-line filters.

PLUS SX housings are manufactured with the finest and most advanced materials under constant focus on innovative processing technologies and ceaseless modernization to ensure the absolute quality of our products.

### CERTIFICATIONS



A range of housings is certified by IAPMO RT to NSF/ANSI 42, 61, 372 - lead free, CSA B483.1. In compliance with Drinking Water Treatment Units regulations, USA and Canada.



Housings are tested and certified under the most stringent procedures worldwide, in compliance with DM 25 (Italy), with the sanitary certification ACS (France), EAC/Ghostreghistracia (Russia) and WaterMark (Australia).

### SYMBOLS LEGEND



For domestic use



For technical and industrial use



Filter housings made in PET, a highly recyclable plastic, are manufactured with a proprietary procedure saving up to 60% of energy in injection molding compared with standard plastics. That is one of Atlas Filtri commitments for the reduction of green house gas (CO<sub>2</sub>) emissions in the atmosphere.

### ACCESSORIES ON DEMAND



-U- spanner CODE RB7403013



-S- wall bracket CODE RB7400007



-D- wall bracket CODE RB7400009



-T- wall bracket CODE RB7401010



3/4" brass nipples with o-ring (pair) CODE RB7404001

1" brass nipples with o-ring (pair) CODE RB7404002



3/4" plastic nipple with o-ring CODE LB7404012



3/4"-1/4" plastic reduction with o-ring CODE LB9020611



4" diffuser tubes CODE LB7405002

5" diffuser tubes CODE LB7405003

7" diffuser tubes CODE LB7405004











10" diffuser tubes CODE LB7405005

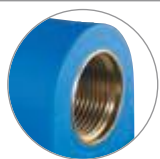
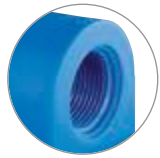

-LUBRIKIT- single-dose lubricant for housing o-ring  
CODE RE9020650

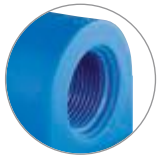
HOUSINGS RANGE

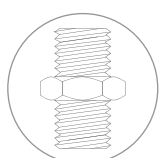
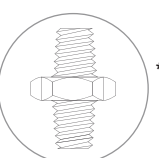

<p><b>SENIOR</b></p> <p>HOUSINGS MODEL</p> <ul style="list-style-type: none"> <li>CADET DUPLEX</li> <li>MEDIUM DUPLEX</li> <li>JUNIOR DUPLEX</li> <li>SENIOR DUPLEX</li> <li>MASTER DUPLEX</li> </ul>  <ul style="list-style-type: none"> <li>CADET TRIPLEX</li> <li>MEDIUM TRIPLEX</li> <li>JUNIOR TRIPLEX</li> <li>SENIOR TRIPLEX</li> <li>MASTER TRIPLEX</li> </ul> 	<p><b>PLUS</b></p> <p>PLUS</p>  <p>PLUS M</p> 	<p><b>3P</b></p> <p>VERSION</p> <ul style="list-style-type: none"> <li>3P</li> <li>2P</li> </ul>	<p><b>A</b></p> <p>IN / OUT</p> <ul style="list-style-type: none"> <li>M 1/2"</li> <li>A 3/4"</li> <li>B 1"</li> </ul>	<p><b>FO</b></p> <p>THREADS TYPE</p> <ul style="list-style-type: none"> <li>FO - BRASS BSP *</li> <li>FP - PLASTIC BSP *</li> <li>MP - PLASTIC BSP *</li> </ul>   	<p><b>SX</b></p> <p>CARTRIDGE TYPE</p> <ul style="list-style-type: none"> <li>SX - STANDARD FLAT SEALS</li> <li>FP NPT - PLASTIC NPT **</li> </ul>  	<p><b>TS</b></p> <p>BOWL TYPE</p> <ul style="list-style-type: none"> <li>TS - CLEAR (PET)</li> <li>AS - CLEAR (SAN)</li> <li>AB - BLUE (PET)</li> </ul>   
				 <p>* BSP parallel (cylindrical) ISO 228</p>	 <p>** NPT tapered (conical) ANSI/ASME B1.20.1</p>	





# PLUS 3P SX

## WORKING CONDITIONS

Max working pressure:  
 BSP versions \_\_\_\_\_ 8 bar (116 psi)  
 NPT versions \_\_\_\_\_ 8,6 bar (125 psi)  
 Max working temperature \_\_\_\_\_ 45°C (113°F)  
 Min working temperature \_\_\_\_\_ 4°C (39,2°F)

## SPECIFICATIONS

Non-toxic materials, suitable for drinking water.  
 Head and ring nut: reinforced polypropylene.  
 Bowl: PET.  
 O-ring: EPDM.  
 Breather-valve: body polypropylene, o-ring EPDM.  
 IN/OUT brass threads: CW 617 N brass.

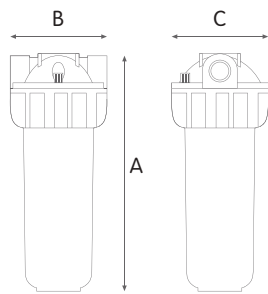

## PLUS 3P SX clear housings

### HOUSINGS WITH BRASS BSP THREADS

CODE	MODEL	SUITABLE CARTRIDGE	IN/OUT	DIMENSIONS mm		
				A	B	C
RA107T111	MEDIUM PLUS 3P MFO SX TS	5"	1/2"	191	133	130
RA107T411	MEDIUM PLUS 3P AFO SX TS	5"	3/4"	191	133	130
RA107T711	MEDIUM PLUS 3P BFO SX TS	5"	1"	197	145	130
RA109T111	JUNIOR PLUS 3P MFO SX TS	7"	1/2"	241	133	130
RA109T411	JUNIOR PLUS 3P AFO SX TS	7"	3/4"	241	133	130
RA109T711	JUNIOR PLUS 3P BFO SX TS	7"	1"	247	145	130
RA111T111	SENIOR PLUS 3P MFO SX TS	10"	1/2"	315	133	130
RA111T411	SENIOR PLUS 3P AFO SX TS	10"	3/4"	315	133	130
RA111T711	SENIOR PLUS 3P BFO SX TS	10"	1"	321	145	130
RA115T111	MASTER PLUS 3P MFO SX TS	20"	1/2"	571	133	130
RA115T411	MASTER PLUS 3P AFO SX TS	20"	3/4"	571	133	130
RA115T711	MASTER PLUS 3P BFO SX TS	20"	1"	577	145	130

### HOUSINGS WITH PLASTIC BSP THREADS

CODE	MODEL	SUITABLE CARTRIDGE	IN/OUT	DIMENSIONS mm		
				A	B	C
RA107T211	MEDIUM PLUS 3P MFP SX TS	5"	1/2"	191	133	130
RA107T511	MEDIUM PLUS 3P AFP SX TS	5"	3/4"	191	133	130
RA107T811	MEDIUM PLUS 3P BFP SX TS	5"	1"	197	145	130
RA109T211	JUNIOR PLUS 3P MFP SX TS	7"	1/2"	241	133	130
RA109T511	JUNIOR PLUS 3P AFP SX TS	7"	3/4"	241	133	130
RA109T811	JUNIOR PLUS 3P BFP SX TS	7"	1"	247	145	130
RA111T211	SENIOR PLUS 3P MFP SX TS	10"	1/2"	315	133	130
RA111T511	SENIOR PLUS 3P AFP SX TS	10"	3/4"	315	133	130
RA111T811	SENIOR PLUS 3P BFP SX TS	10"	1"	321	145	130
RA115T211	MASTER PLUS 3P MFP SX TS	20"	1/2"	571	133	130
RA115T511	MASTER PLUS 3P AFP SX TS	20"	3/4"	571	133	130
RA115T811	MASTER PLUS 3P BFP SX TS	20"	1"	577	145	130

### HOUSINGS WITH PLASTIC NPT THREADS

CODE	MODEL	SUITABLE CARTRIDGE	IN/OUT	DIMENSIONS mm		
				A	B	C
RA107T513	MEDIUM PLUS 3P AFP NPT SX TS	5"	3/4"	191	133	130
RA107T813	MEDIUM PLUS 3P BFP NPT SX TS	5"	1"	197	145	130
RA109T513	JUNIOR PLUS 3P AFP NPT SX TS	7"	3/4"	241	133	130
RA109T813	JUNIOR PLUS 3P BFP NPT SX TS	7"	1"	247	145	130
RA111T610	SENIOR PLUS 3P AFP NPT SX TS	10"	3/4"	315	133	130
RA111T611	SENIOR PLUS 3P BFP NPT SX TS	10"	1"	321	145	130
RA115T611	MASTER PLUS 3P AFP NPT SX TS	20"	3/4"	571	133	130
RA115T813	MASTER PLUS 3P BFP NPT SX TS	20"	1"	577	145	130

### HOUSINGS WITH PLASTIC BSP THREADS

CODE	MODEL	SUITABLE CARTRIDGE	IN/OUT	DIMENSIONS mm		
				A	B	C
RA107T215	MEDIUM PLUS 3P MMP SX TS	5"	1/2"	191	175	130
RA107T515	MEDIUM PLUS 3P AMP SX TS	5"	3/4"	191	175	130
RA107T815	MEDIUM PLUS 3P BMP SX TS	5"	1"	197	175	130
RA109T215	JUNIOR PLUS 3P MMP SX TS	7"	1/2"	241	175	130
RA109T515	JUNIOR PLUS 3P AMP SX TS	7"	3/4"	241	175	130
RA109T815	JUNIOR PLUS 3P BMP SX TS	7"	1"	247	175	130
RA111T215	SENIOR PLUS 3P MMP SX TS	10"	1/2"	315	175	130
RA111T515	SENIOR PLUS 3P AMP SX TS	10"	3/4"	315	175	130
RA111T815	SENIOR PLUS 3P BMP SX TS	10"	1"	321	175	130
RA115T215	MASTER PLUS 3P MMP SX TS	20"	1/2"	571	175	130
RA115T515	MASTER PLUS 3P AMP SX TS	20"	3/4"	571	175	130
RA115T815	MASTER PLUS 3P BMP SX TS	20"	1"	577	175	130

## VARIANTS AVAILABLE ON MINIMUM QUANTITY:

- RT housings suitable for filter cartridges with length 508 mm

Some items in the list are subject to minimum order quantities and/or to longer delivery term.



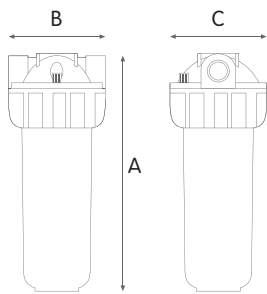

**WORKING CONDITIONS**

Max working pressure:  
 BSP versions \_\_\_\_\_ 8 bar (116 psi)  
 NPT versions \_\_\_\_\_ 8,6 bar (125 psi)  
 Max working temperature \_\_\_\_\_ 45°C (113°F)  
 Min working temperature \_\_\_\_\_ 4°C (39,2°F)

**SPECIFICATIONS**

Non-toxic materials, suitable for drinking water.  
 Head and ring nut: reinforced polypropylene.  
 Bowl: PET.  
 O-ring: EPDM.  
 Breather-valve: body polypropylene, o-ring EPDM.  
 IN/OUT brass threads: CW 617 N brass.

**PLUS 3P SX blue housings**

**HOUSINGS WITH BRASS BSP THREADS**

CODE	MODEL	SUITABLE CARTRIDGE	IN/OUT	DIMENSIONS mm		
				A	B	C
RA107T112	MEDIUM PLUS 3P MFO SX AB	5"	1/2"	191	133	130
RA107T412	MEDIUM PLUS 3P AFO SX AB	5"	3/4"	191	133	130
RA107T712	MEDIUM PLUS 3P BFO SX AB	5"	1"	197	145	130
RA109T112	JUNIOR PLUS 3P MFO SX AB	7"	1/2"	241	133	130
RA109T412	JUNIOR PLUS 3P AFO SX AB	7"	3/4"	241	133	130
RA109T712	JUNIOR PLUS 3P BFO SX AB	7"	1"	247	145	130
RA111T112	SENIOR PLUS 3P MFO SX AB	10"	1/2"	315	133	130
RA111T412	SENIOR PLUS 3P AFO SX AB	10"	3/4"	315	133	130
RA111T712	SENIOR PLUS 3P BFO SX AB	10"	1"	321	145	130
RA115T112	MASTER PLUS 3P MFO SX AB	20"	1/2"	571	133	130
RA115T412	MASTER PLUS 3P AFO SX AB	20"	3/4"	571	133	130
RA115T712	MASTER PLUS 3P BFO SX AB	20"	1"	577	145	130

**HOUSINGS WITH PLASTIC BSP THREADS**

CODE	MODEL	SUITABLE CARTRIDGE	IN/OUT	DIMENSIONS mm		
				A	B	C
RA107T212	MEDIUM PLUS 3P MFP SX AB	5"	1/2"	191	133	130
RA107T512	MEDIUM PLUS 3P AFP SX AB	5"	3/4"	191	133	130
RA107T812	MEDIUM PLUS 3P BFP SX AB	5"	1"	197	145	130
RA109T212	JUNIOR PLUS 3P MFP SX AB	7"	1/2"	241	133	130
RA109T512	JUNIOR PLUS 3P AFP SX AB	7"	3/4"	241	133	130
RA109T812	JUNIOR PLUS 3P BFP SX AB	7"	1"	247	145	130
RA111T212	SENIOR PLUS 3P MFP SX AB	10"	1/2"	315	133	130
RA111T512	SENIOR PLUS 3P AFP SX AB	10"	3/4"	315	133	130
RA111T812	SENIOR PLUS 3P BFP SX AB	10"	1"	321	145	130
RA115T212	MASTER PLUS 3P MFP SX AB	20"	1/2"	571	133	130
RA115T512	MASTER PLUS 3P AFP SX AB	20"	3/4"	571	133	130
RA115T812	MASTER PLUS 3P BFP SX AB	20"	1"	577	145	130

**HOUSINGS WITH PLASTIC NPT THREADS**

CODE	MODEL	SUITABLE CARTRIDGE	IN/OUT	DIMENSIONS mm		
				A	B	C
RA107T514	MEDIUM PLUS 3P AFP NPT SX AB	5"	3/4"	191	133	130
RA107T814	MEDIUM PLUS 3P BFP NPT SX AB	5"	1"	197	145	130
RA109T514	JUNIOR PLUS 3P AFP NPT SX AB	7"	3/4"	241	133	130
RA109T814	JUNIOR PLUS 3P BFP NPT SX AB	7"	1"	247	145	130
RA111T612	SENIOR PLUS 3P AFP NPT SX AB	10"	3/4"	315	133	130
RA111T613	SENIOR PLUS 3P BFP NPT SX AB	10"	1"	321	145	130
RA115T612	MASTER PLUS 3P AFP NPT SX AB	20"	3/4"	571	133	130
RA115T814	MASTER PLUS 3P BFP NPT SX AB	20"	1"	577	145	130

**HOUSINGS WITH PLASTIC BSP THREADS**

CODE	MODEL	SUITABLE CARTRIDGE	IN/OUT	DIMENSIONS mm		
				A	B	C
RA107T216	MEDIUM PLUS 3P MMP SX AB	5"	1/2"	191	175	130
RA107T516	MEDIUM PLUS 3P AMP SX AB	5"	3/4"	191	175	130
RA107T816	MEDIUM PLUS 3P BMP SX AB	5"	1"	197	175	130
RA109T216	JUNIOR PLUS 3P MMP SX AB	7"	1/2"	241	175	130
RA109T516	JUNIOR PLUS 3P AMP SX AB	7"	3/4"	241	175	130
RA109T816	JUNIOR PLUS 3P BMP SX AB	7"	1"	247	175	130
RA111T216	SENIOR PLUS 3P MMP SX AB	10"	1/2"	315	175	130
RA111T516	SENIOR PLUS 3P AMP SX AB	10"	3/4"	315	175	130
RA111T816	SENIOR PLUS 3P BMP SX AB	10"	1"	321	175	130
RA115T216	MASTER PLUS 3P MMP SX AB	20"	1/2"	571	175	130
RA115T516	MASTER PLUS 3P AMP SX AB	20"	3/4"	571	175	130
RA115T816	MASTER PLUS 3P BMP SX AB	20"	1"	577	175	130

**VARIANTS AVAILABLE ON MINIMUM QUANTITY:**

- RT housings suitable for filter cartridges with length 508 mm

Some items in the list are subject to minimum order quantities and/or to longer delivery term.



# PLUS M 3P SX

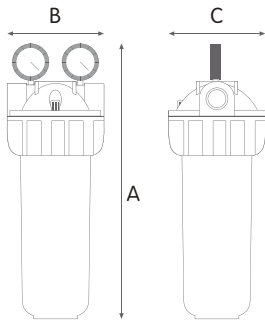

## WORKING CONDITIONS

Max working pressure:  
 BSP versions \_\_\_\_\_ 8 bar (116 psi)  
 NPT versions \_\_\_\_\_ 8,6 bar (125 psi)  
 Max working temperature \_\_\_\_\_ 45°C (113°F)  
 Min working temperature \_\_\_\_\_ 4°C (39,2°F)

## SPECIFICATIONS

Non-toxic materials, suitable for drinking water.  
 Head and ring nut: reinforced polypropylene.  
 Bowl: PET.  
 O-ring: EPDM.  
 Breather-valve: body polypropylene, o-ring EPDM.  
 IN/OUT brass threads: CW 617 N brass.  
 Manometers: radial type, pressure range 0-12 bar, 0-170 psi.

## PLUS M 3P SX clear housings with 2 manometers

### HOUSINGS WITH BRASS BSP THREADS

CODE	MODEL	SUITABLE CARTRIDGE	IN/OUT	DIMENSIONS mm		
				A	B	C
RA107T114	MEDIUM PLUS M 3P MFO SX TS	5"	1/2"	241	133	130
RA107T414	MEDIUM PLUS M 3P AFO SX TS	5"	3/4"	241	133	130
RA107T714	MEDIUM PLUS M 3P BFO SX TS	5"	1"	247	145	130
RA109T114	JUNIOR PLUS M 3P MFO SX TS	7"	1/2"	291	133	130
RA109T414	JUNIOR PLUS M 3P AFO SX TS	7"	3/4"	291	133	130
RA109T714	JUNIOR PLUS M 3P BFO SX TS	7"	1"	297	145	130
RA111T114	SENIOR PLUS M 3P MFO SX TS	10"	1/2"	365	133	130
RA111T414	SENIOR PLUS M 3P AFO SX TS	10"	3/4"	365	133	130
RA111T714	SENIOR PLUS M 3P BFO SX TS	10"	1"	371	145	130
RA115T114	MASTER PLUS M 3P MFO SX TS	20"	1/2"	621	133	130
RA115T414	MASTER PLUS M 3P AFO SX TS	20"	3/4"	621	133	130
RA115T714	MASTER PLUS M 3P BFO SX TS	20"	1"	627	145	130

### HOUSINGS WITH PLASTIC BSP THREADS

CODE	MODEL	SUITABLE CARTRIDGE	IN/OUT	DIMENSIONS mm		
				A	B	C
RA107T418	MEDIUM PLUS M 3P AFP SX TS	5"	3/4"	241	133	130
RA107T718	MEDIUM PLUS M 3P BFP SX TS	5"	1"	247	145	130
RA109T418	JUNIOR PLUS M 3P AFP SX TS	7"	3/4"	291	133	130
RA109T718	JUNIOR PLUS M 3P BFP SX TS	7"	1"	297	145	130
RA111T418	SENIOR PLUS M 3P AFP SX TS	10"	3/4"	365	133	130
RA111T718	SENIOR PLUS M 3P BFP SX TS	10"	1"	371	145	130
RA115T418	MASTER PLUS M 3P AFP SX TS	20"	3/4"	621	133	130
RA115T718	MASTER PLUS M 3P BFP SX TS	20"	1"	627	145	130

### HOUSINGS WITH PLASTIC NPT THREADS

CODE	MODEL	SUITABLE CARTRIDGE	IN/OUT	DIMENSIONS mm		
				A	B	C
RA107T416	MEDIUM PLUS M 3P AFP NPT SX TS	5"	3/4"	241	133	130
RA107T716	MEDIUM PLUS M 3P BFP NPT SX TS	5"	1"	247	145	130
RA109T416	JUNIOR PLUS M 3P AFP NPT SX TS	7"	3/4"	291	133	130
RA109T716	JUNIOR PLUS M 3P BFP NPT SX TS	7"	1"	297	145	130
RA111T416	SENIOR PLUS M 3P AFP NPT SX TS	10"	3/4"	365	133	130
RA111T716	SENIOR PLUS M 3P BFP NPT SX TS	10"	1"	371	145	130
RA115T416	MASTER PLUS M 3P AFP NPT SX TS	20"	3/4"	621	133	130
RA115T716	MASTER PLUS M 3P BFP NPT SX TS	20"	1"	627	145	130

## VARIANTS AVAILABLE ON MINIMUM QUANTITY:

- RT housings suitable for filter cartridges with length 508 mm

Some items in the list are subject to minimum order quantities and/or to longer delivery term.

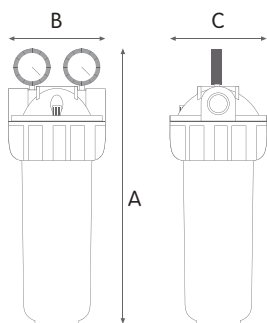

**WORKING CONDITIONS**

Max working pressure:  
 BSP versions \_\_\_\_\_ 8 bar (116 psi)  
 NPT versions \_\_\_\_\_ 8,6 bar (125 psi)  
 Max working temperature \_\_\_\_\_ 45°C (113°F)  
 Min working temperature \_\_\_\_\_ 4°C (39,2°F)

**SPECIFICATIONS**

Non-toxic materials, suitable for drinking water.  
 Head and ring nut: reinforced polypropylene.  
 Bowl: PET.  
 O-ring: EPDM.  
 Breather-valve: body polypropylene, o-ring EPDM.  
 IN/OUT brass threads: CW 617 N brass.  
 Manometers: radial type, pressure range 0-12 bar, 0-170 psi.

**PLUS M 3P SX blue housings with 2 manometers**

**HOUSINGS WITH BRASS BSP THREADS**

CODE	MODEL	SUITABLE CARTRIDGE	IN/OUT	DIMENSIONS mm		
				A	B	C
RA107T115	MEDIUM PLUS M 3P MFO SX AB	5"	1/2"	241	133	130
RA107T415	MEDIUM PLUS M 3P AFO SX AB	5"	3/4"	241	133	130
RA107T715	MEDIUM PLUS M 3P BFO SX AB	5"	1"	247	145	130
RA109T115	JUNIOR PLUS M 3P MFO SX AB	7"	1/2"	291	133	130
RA109T415	JUNIOR PLUS M 3P AFO SX AB	7"	3/4"	291	133	130
RA109T715	JUNIOR PLUS M 3P BFO SX AB	7"	1"	297	145	130
RA111T115	SENIOR PLUS M 3P MFO SX AB	10"	1/2"	365	133	130
RA111T415	SENIOR PLUS M 3P AFO SX AB	10"	3/4"	365	133	130
RA111T715	SENIOR PLUS M 3P BFO SX AB	10"	1"	371	145	130
RA115T115	MASTER PLUS M 3P MFO SX AB	20"	1/2"	621	133	130
RA115T415	MASTER PLUS M 3P AFO SX AB	20"	3/4"	621	133	130
RA115T715	MASTER PLUS M 3P BFO SX AB	20"	1"	627	145	130

**HOUSINGS WITH PLASTIC BSP THREADS**

CODE	MODEL	SUITABLE CARTRIDGE	IN/OUT	DIMENSIONS mm		
				A	B	C
RA107T419	MEDIUM PLUS M 3P AFP SX AB	5"	3/4"	241	133	130
RA107T719	MEDIUM PLUS M 3P BFP SX AB	5"	1"	247	145	130
RA109T419	JUNIOR PLUS M 3P AFP SX AB	7"	3/4"	291	133	130
RA109T719	JUNIOR PLUS M 3P BFP SX AB	7"	1"	297	145	130
RA111T419	SENIOR PLUS M 3P AFP SX AB	10"	3/4"	365	133	130
RA111T719	SENIOR PLUS M 3P BFP SX AB	10"	1"	371	145	130
RA115T419	MASTER PLUS M 3P AFP SX AB	20"	3/4"	621	133	130
RA115T719	MASTER PLUS M 3P BFP SX AB	20"	1"	627	145	130

**HOUSINGS WITH PLASTIC NPT THREADS**

CODE	MODEL	SUITABLE CARTRIDGE	IN/OUT	DIMENSIONS mm		
				A	B	C
RA107T417	MEDIUM PLUS M 3P AFP NPT SX AB	5"	3/4"	241	133	130
RA107T717	MEDIUM PLUS M 3P BFP NPT SX AB	5"	1"	247	145	130
RA109T417	JUNIOR PLUS M 3P AFP NPT SX AB	7"	3/4"	291	133	130
RA109T717	JUNIOR PLUS M 3P BFP NPT SX AB	7"	1"	297	145	130
RA111T417	SENIOR PLUS M 3P AFP NPT SX AB	10"	3/4"	365	133	130
RA111T717	SENIOR PLUS M 3P BFP NPT SX AB	10"	1"	371	145	130
RA115T417	MASTER PLUS M 3P AFP NPT SX AB	20"	3/4"	621	133	130
RA115T717	MASTER PLUS M 3P BFP NPT SX AB	20"	1"	627	145	130

**VARIANTS AVAILABLE ON MINIMUM QUANTITY:**

- RT housings suitable for filter cartridges with length 508 mm

Some items in the list are subject to minimum order quantities and/or to longer delivery term.



# DUPLEX PLUS 3P SX

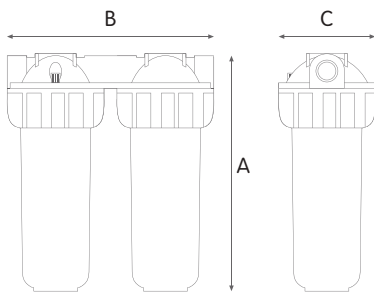

## WORKING CONDITIONS

Max working pressure:  
 BSP versions \_\_\_\_\_ 8 bar (116 psi)  
 NPT versions \_\_\_\_\_ 8,6 bar (125 psi)  
 Max working temperature \_\_\_\_\_ 45°C (113°F)  
 Min working temperature \_\_\_\_\_ 4°C (39,2°F)

## SPECIFICATIONS

Non-toxic materials, suitable for drinking water.  
 Head and ring nut: reinforced polypropylene.  
 Bowl: PET.  
 O-ring: EPDM.  
 Breather-valve: body polypropylene, o-ring EPDM.  
 IN/OUT brass threads: CW 617 N brass.

## DUPLEX PLUS 3P SX clear housings

### HOUSINGS WITH BRASS BSP THREADS

CODE	MODEL	SUITABLE CARTRIDGE	IN/OUT	DIMENSIONS mm		
				A	B	C
RA108T411	MEDIUM DUPLEX PLUS 3P AFO SX TS	5"	3/4"	191	275	130
RA108T711	MEDIUM DUPLEX PLUS 3P BFO SX TS	5"	1"	191	275	130
RA110T411	JUNIOR DUPLEX PLUS 3P AFO SX TS	7"	3/4"	241	275	130
RA110T711	JUNIOR DUPLEX PLUS 3P BFO SX TS	7"	1"	241	275	130
RA112T411	SENIOR DUPLEX PLUS 3P AFO SX TS	10"	3/4"	315	275	130
RA112T711	SENIOR DUPLEX PLUS 3P BFO SX TS	10"	1"	315	275	130
RA116T411	MASTER DUPLEX PLUS 3P AFO SX TS	20"	3/4"	571	275	130
RA116T711	MASTER DUPLEX PLUS 3P BFO SX TS	20"	1"	571	275	130

### HOUSINGS WITH PLASTIC BSP THREADS

CODE	MODEL	SUITABLE CARTRIDGE	IN/OUT	DIMENSIONS mm		
				A	B	C
RA108T511	MEDIUM DUPLEX PLUS 3P AFP SX TS	5"	3/4"	191	275	130
RA110T511	JUNIOR DUPLEX PLUS 3P AFP SX TS	7"	3/4"	241	275	130
RA112T511	SENIOR DUPLEX PLUS 3P AFP SX TS	10"	3/4"	315	275	130
RA116T511	MASTER DUPLEX PLUS 3P AFP SX TS	20"	3/4"	571	275	130

### HOUSINGS WITH PLASTIC NPT THREADS

CODE	MODEL	SUITABLE CARTRIDGE	IN/OUT	DIMENSIONS mm		
				A	B	C
RA108T513	MEDIUM DUPLEX PLUS 3P AFP NPT SX TS	5"	3/4"	191	275	130
RA110T513	JUNIOR DUPLEX PLUS 3P AFP NPT SX TS	7"	3/4"	241	275	130
RA112T611	SENIOR DUPLEX PLUS 3P AFP NPT SX TS	10"	3/4"	315	275	130
RA116T611	MASTER DUPLEX PLUS 3P AFP NPT SX TS	20"	3/4"	571	275	130

## VARIANTS AVAILABLE ON MINIMUM QUANTITY:

- RT housings suitable for filter cartridges with length 508 mm

Some items in the list are subject to minimum order quantities and/or to longer delivery term.

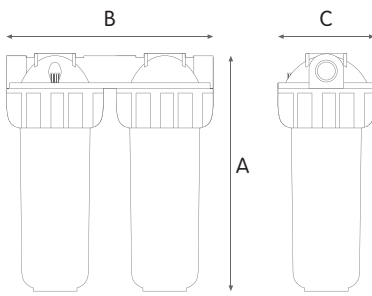

**WORKING CONDITIONS**

Max working pressure:  
 BSP versions \_\_\_\_\_ 8 bar (116 psi)  
 NPT versions \_\_\_\_\_ 8,6 bar (125 psi)  
 Max working temperature \_\_\_\_\_ 45°C (113°F)  
 Min working temperature \_\_\_\_\_ 4°C (39,2°F)

**SPECIFICATIONS**

Non-toxic materials, suitable for drinking water.  
 Head and ring nut: reinforced polypropylene.  
 Bowl: PET.  
 O-ring: EPDM.  
 Breather-valve: body polypropylene, o-ring EPDM.  
 IN/OUT brass threads: CW 617 N brass.

**DUPLEX PLUS 3P SX blue housings**

**HOUSINGS WITH BRASS BSP THREADS**

CODE	MODEL	SUITABLE CARTRIDGE	IN/OUT	DIMENSIONS mm		
				A	B	C
RA108T412	MEDIUM DUPLEX PLUS 3P AFO SX AB	5"	3/4"	191	275	130
RA108T712	MEDIUM DUPLEX PLUS 3P BFO SX AB	5"	1"	191	275	130
RA110T412	JUNIOR DUPLEX PLUS 3P AFO SX AB	7"	3/4"	241	275	130
RA110T712	JUNIOR DUPLEX PLUS 3P BFO SX AB	7"	1"	241	275	130
RA112T412	SENIOR DUPLEX PLUS 3P AFO SX AB	10"	3/4"	315	275	130
RA112T712	SENIOR DUPLEX PLUS 3P BFO SX AB	10"	1"	315	275	130
RA116T412	MASTER DUPLEX PLUS 3P AFO SX AB	20"	3/4"	571	275	130
RA116T712	MASTER DUPLEX PLUS 3P BFO SX AB	20"	1"	571	275	130

**HOUSINGS WITH PLASTIC BSP THREADS**

CODE	MODEL	SUITABLE CARTRIDGE	IN/OUT	DIMENSIONS mm		
				A	B	C
RA108T512	MEDIUM DUPLEX PLUS 3P AFP SX AB	5"	3/4"	191	275	130
RA110T512	JUNIOR DUPLEX PLUS 3P AFP SX AB	7"	3/4"	241	275	130
RA112T512	SENIOR DUPLEX PLUS 3P AFP SX AB	10"	3/4"	315	275	130
RA116T512	MASTER DUPLEX PLUS 3P AFP SX AB	20"	3/4"	571	275	130

**HOUSINGS WITH PLASTIC NPT THREADS**

CODE	MODEL	SUITABLE CARTRIDGE	IN/OUT	DIMENSIONS mm		
				A	B	C
RA108T514	MEDIUM DUPLEX PLUS 3P AFP NPT SX AB	5"	3/4"	191	275	130
RA110T514	JUNIOR DUPLEX PLUS 3P AFP NPT SX AB	7"	3/4"	241	275	130
RA112T612	SENIOR DUPLEX PLUS 3P AFP NPT SX AB	10"	3/4"	315	275	130
RA116T612	MASTER DUPLEX PLUS 3P AFP NPT SX AB	20"	3/4"	571	275	130

**VARIANTS AVAILABLE ON MINIMUM QUANTITY:**

- RT housings suitable for filter cartridges with length 508 mm

Some items in the list are subject to minimum order quantities and/or to longer delivery term.





# TRIPLEX PLUS 3P SX

## WORKING CONDITIONS

Max working pressure:  
 BSP versions \_\_\_\_\_ 8 bar (116 psi)  
 NPT versions \_\_\_\_\_ 8,6 bar (125 psi)  
 Max working temperature \_\_\_\_\_ 45°C (113°F)  
 Min working temperature \_\_\_\_\_ 4°C (39,2°F)

## SPECIFICATIONS

Non-toxic materials, suitable for drinking water.  
 Head and ring nut: reinforced polypropylene.  
 Bowl: PET.  
 O-ring: EPDM.  
 Breather-valve: body polypropylene, o-ring EPDM.  
 IN/OUT brass threads: CW 617 N brass.

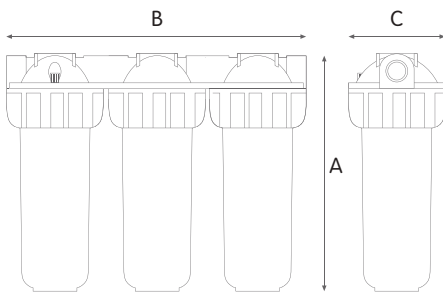

## TRIPLEX PLUS 3P SX clear housings

### HOUSINGS WITH BRASS BSP THREADS



CODE	MODEL	SUITABLE CARTRIDGE	IN/OUT	DIMENSIONS mm		
				A	B	C
RA108T431	MEDIUM TRIPLEX PLUS 3P AFO SX TS	5"	3/4"	191	420	130
RA108T731	MEDIUM TRIPLEX PLUS 3P BFO SX TS	5"	1"	191	420	130
RA110T431	JUNIOR TRIPLEX PLUS 3P AFO SX TS	7"	3/4"	241	420	130
RA110T731	JUNIOR TRIPLEX PLUS 3P BFO SX TS	7"	1"	241	420	130
RA112T431	SENIOR TRIPLEX PLUS 3P AFO SX TS	10"	3/4"	315	420	130
RA112T731	SENIOR TRIPLEX PLUS 3P BFO SX TS	10"	1"	315	420	130
RA116T431	MASTER TRIPLEX PLUS 3P AFO SX TS	20"	3/4"	571	420	130
RA116T731	MASTER TRIPLEX PLUS 3P BFO SX TS	20"	1"	571	420	130

### HOUSINGS WITH PLASTIC BSP THREADS



CODE	MODEL	SUITABLE CARTRIDGE	IN/OUT	DIMENSIONS mm		
				A	B	C
RA108T531	MEDIUM TRIPLEX PLUS 3P AFP SX TS	5"	3/4"	191	420	130
RA108T831	MEDIUM TRIPLEX PLUS 3P BFP SX TS	5"	1"	191	420	130
RA110T531	JUNIOR TRIPLEX PLUS 3P AFP SX TS	7"	3/4"	241	420	130
RA110T831	JUNIOR TRIPLEX PLUS 3P BFP SX TS	7"	1"	241	420	130
RA112T531	SENIOR TRIPLEX PLUS 3P AFP SX TS	10"	3/4"	315	420	130
RA112T831	SENIOR TRIPLEX PLUS 3P BFP SX TS	10"	1"	315	420	130
RA116T531	MASTER TRIPLEX PLUS 3P AFP SX TS	20"	3/4"	571	420	130
RA116T831	MASTER TRIPLEX PLUS 3P BFP SX TS	20"	1"	571	420	130

### HOUSINGS WITH PLASTIC NPT THREADS

CODE	MODEL	SUITABLE CARTRIDGE	IN/OUT	DIMENSIONS mm		
				A	B	C
RA108T533	MEDIUM TRIPLEX PLUS 3P AFP NPT SX TS	5"	3/4"	191	420	130
RA110T533	JUNIOR TRIPLEX PLUS 3P AFP NPT SX TS	7"	3/4"	241	420	130
RA112T533	SENIOR TRIPLEX PLUS 3P AFP NPT SX TS	10"	3/4"	315	420	130
RA116T533	MASTER TRIPLEX PLUS 3P AFP NPT SX TS	20"	3/4"	571	420	130

## VARIANTS AVAILABLE ON MINIMUM QUANTITY:

- RT housings suitable for filter cartridges with length 508 mm

Some items in the list are subject to minimum order quantities and/or to longer delivery term.

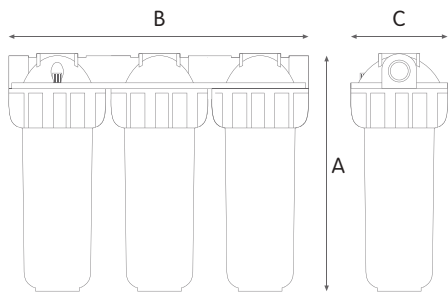

**WORKING CONDITIONS**

Max working pressure:  
 BSP versions \_\_\_\_\_ 8 bar (116 psi)  
 NPT versions \_\_\_\_\_ 8,6 bar (125 psi)  
 Max working temperature \_\_\_\_\_ 45°C (113°F)  
 Min working temperature \_\_\_\_\_ 4°C (39,2°F)

**SPECIFICATIONS**

Non-toxic materials, suitable for drinking water.  
 Head and ring nut: reinforced polypropylene.  
 Bowl: PET.  
 O-ring: EPDM.  
 Breather-valve: body polypropylene, o-ring EPDM.  
 IN/OUT brass threads: CW 617 N brass.

**TRIPLEX PLUS 3P SX blue housings**

**HOUSINGS WITH BRASS BSP THREADS**

CODE	MODEL	SUITABLE CARTRIDGE	IN/OUT	DIMENSIONS mm		
				A	B	C
RA108T432	MEDIUM TRIPLEX PLUS 3P AFO SX AB	5"	3/4"	191	420	130
RA108T732	MEDIUM TRIPLEX PLUS 3P BFO SX AB	5"	1"	191	420	130
RA110T432	JUNIOR TRIPLEX PLUS 3P AFO SX AB	7"	3/4"	241	420	130
RA110T732	JUNIOR TRIPLEX PLUS 3P BFO SX AB	7"	1"	241	420	130
RA112T432	SENIOR TRIPLEX PLUS 3P AFO SX AB	10"	3/4"	315	420	130
RA112T732	SENIOR TRIPLEX PLUS 3P BFO SX AB	10"	1"	315	420	130
RA116T432	MASTER TRIPLEX PLUS 3P AFO SX AB	20"	3/4"	571	420	130
RA116T732	MASTER TRIPLEX PLUS 3P BFO SX AB	20"	1"	571	420	130

**HOUSINGS WITH PLASTIC BSP THREADS**

CODE	MODEL	SUITABLE CARTRIDGE	IN/OUT	DIMENSIONS mm		
				A	B	C
RA108T532	MEDIUM TRIPLEX PLUS 3P AFP SX AB	5"	3/4"	191	420	130
RA108T832	MEDIUM TRIPLEX PLUS 3P BFP SX AB	5"	1"	191	420	130
RA110T532	JUNIOR TRIPLEX PLUS 3P AFP SX AB	7"	3/4"	241	420	130
RA110T832	JUNIOR TRIPLEX PLUS 3P BFP SX AB	7"	1"	241	420	130
RA112T532	SENIOR TRIPLEX PLUS 3P AFP SX AB	10"	3/4"	315	420	130
RA112T832	SENIOR TRIPLEX PLUS 3P BFP SX AB	10"	1"	315	420	130
RA116T532	MASTER TRIPLEX PLUS 3P AFP SX AB	20"	3/4"	571	420	130
RA116T832	MASTER TRIPLEX PLUS 3P BFP SX AB	20"	1"	571	420	130

**HOUSINGS WITH PLASTIC NPT THREADS**

CODE	MODEL	SUITABLE CARTRIDGE	IN/OUT	DIMENSIONS mm		
				A	B	C
RA108T534	MEDIUM TRIPLEX PLUS 3P AFP NPT SX AB	5"	3/4"	191	420	130
RA110T534	JUNIOR TRIPLEX PLUS 3P AFP NPT SX AB	7"	3/4"	241	420	130
RA112T534	SENIOR TRIPLEX PLUS 3P AFP NPT SX AB	10"	3/4"	315	420	130
RA116T534	MASTER TRIPLEX PLUS 3P AFP NPT SX AB	20"	3/4"	571	420	130

**VARIANTS AVAILABLE ON MINIMUM QUANTITY:**

- RT housings suitable for filter cartridges with length 508 mm

Some items in the list are subject to minimum order quantities and/or to longer delivery term.



# PLUS 2P SX

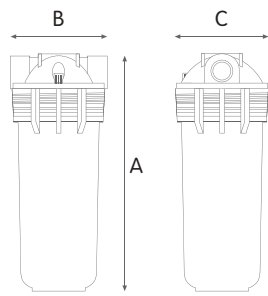

## WORKING CONDITIONS

Max working pressure \_\_\_\_\_ 8 bar (116 psi)  
 Max working temperature \_\_\_\_\_ 45°C (113°F)  
 Min working temperature \_\_\_\_\_ 4°C (39,2°F)

## SPECIFICATIONS

Non-toxic materials, suitable for drinking water.  
 Head: reinforced polypropylene.  
 Bowl: SAN.  
 O-ring: EPDM.  
 Breather-valve: body polypropylene, o-ring EPDM.  
 IN/OUT brass threads: CW 617 N brass.

## PLUS 2P SX clear housings

### HOUSINGS WITH BRASS BSP THREADS

CODE	MODEL	SUITABLE CARTRIDGE	IN/OUT	DIMENSIONS mm		
				A	B	C
RA117P111	CADET PLUS 2P MFO SX AS	4"	1/2"	169	133	130
RA117P411	CADET PLUS 2P AFO SX AS	4"	3/4"	169	133	130
RA117P711	CADET PLUS 2P BFO SX AS	4"	1"	173	145	130
RA119P111	JUNIOR PLUS 2P MFO SX AS	7"	1/2"	241	133	130
RA119P411	JUNIOR PLUS 2P AFO SX AS	7"	3/4"	241	133	130
RA119P711	JUNIOR PLUS 2P BFO SX AS	7"	1"	247	145	130
RA121P111	SENIOR PLUS 2P MFO SX AS	10"	1/2"	315	133	130
RA121P411	SENIOR PLUS 2P AFO SX AS	10"	3/4"	315	133	130
RA121P711	SENIOR PLUS 2P BFO SX AS	10"	1"	321	145	130

### HOUSINGS WITH PLASTIC BSP THREADS

CODE	MODEL	SUITABLE CARTRIDGE	IN/OUT	DIMENSIONS mm		
				A	B	C
RA117P211	CADET PLUS 2P MFP SX AS	4"	1/2"	169	133	130
RA117P511	CADET PLUS 2P AFP SX AS	4"	3/4"	169	133	130
RA117P811	CADET PLUS 2P BFP SX AS	4"	1"	173	145	130
RA119P211	JUNIOR PLUS 2P MFP SX AS	7"	1/2"	241	133	130
RA119P511	JUNIOR PLUS 2P AFP SX AS	7"	3/4"	241	133	130
RA119P811	JUNIOR PLUS 2P BFP SX AS	7"	1"	247	145	130
RA121P211	SENIOR PLUS 2P MFP SX AS	10"	1/2"	315	133	130
RA121P511	SENIOR PLUS 2P AFP SX AS	10"	3/4"	315	133	130
RA121P811	SENIOR PLUS 2P BFP SX AS	10"	1"	321	145	130

### HOUSINGS WITH PLASTIC NPT THREADS

CODE	MODEL	SUITABLE CARTRIDGE	IN/OUT	DIMENSIONS mm		
				A	B	C
RA117P516	CADET PLUS 2P AFP NPT SX AS	4"	3/4"	169	133	130
RA117P816	CADET PLUS 2P BFP NPT SX AS	4"	1"	173	145	130
RA119P516	JUNIOR PLUS 2P AFP NPT SX AS	7"	3/4"	241	133	130
RA119P816	JUNIOR PLUS 2P BFP NPT SX AS	7"	1"	247	145	130
RA121P516	SENIOR PLUS 2P AFP NPT SX AS	10"	3/4"	315	133	130
RA121P816	SENIOR PLUS 2P BFP NPT SX AS	10"	1"	321	145	130

### HOUSINGS WITH PLASTIC BSP THREADS

CODE	MODEL	SUITABLE CARTRIDGE	IN/OUT	DIMENSIONS mm		
				A	B	C
RA117P214	CADET PLUS 2P MMP SX AS	4"	1/2"	169	175	130
RA117P514	CADET PLUS 2P AMP SX AS	4"	3/4"	169	175	130
RA117P814	CADET PLUS 2P BMP SX AS	4"	1"	173	175	130
RA119P214	JUNIOR PLUS 2P MMP SX AS	7"	1/2"	241	175	130
RA119P514	JUNIOR PLUS 2P AMP SX AS	7"	3/4"	241	175	130
RA119P814	JUNIOR PLUS 2P BMP SX AS	7"	1"	247	175	130
RA121P214	SENIOR PLUS 2P MMP SX AS	10"	1/2"	315	175	130
RA121P514	SENIOR PLUS 2P AMP SX AS	10"	3/4"	315	175	130
RA121P814	SENIOR PLUS 2P BMP SX AS	10"	1"	321	175	130

Some items in the list are subject to minimum order quantities and/or to longer delivery term.

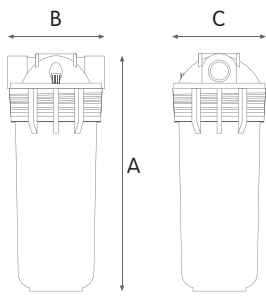

**WORKING CONDITIONS**

Max working pressure \_\_\_\_\_ 8 bar (116 psi)  
 Max working temperature \_\_\_\_\_ 45°C (113°F)  
 Min working temperature \_\_\_\_\_ 4°C (39,2°F)

**SPECIFICATIONS**

Non-toxic materials, suitable for drinking water.  
 Head: reinforced polypropylene.  
 Bowl: reinforced polypropylene.  
 O-ring: EPDM.  
 Breather-valve: body polypropylene, o-ring EPDM.  
 IN/OUT brass threads: CW 617 N brass.

**PLUS 2P SX blue housings**

**HOUSINGS WITH BRASS BSP THREADS**

CODE	MODEL	SUITABLE CARTRIDGE	IN/OUT	DIMENSIONS mm		
				A	B	C
RA117P112	CADET PLUS 2P MFO SX AB	4"	1/2"	169	133	130
RA117P412	CADET PLUS 2P AFO SX AB	4"	3/4"	169	133	130
RA117P712	CADET PLUS 2P BFO SX AB	4"	1"	173	145	130
RA119P112	JUNIOR PLUS 2P MFO SX AB	7"	1/2"	241	133	130
RA119P412	JUNIOR PLUS 2P AFO SX AB	7"	3/4"	241	133	130
RA119P712	JUNIOR PLUS 2P BFO SX AB	7"	1"	247	145	130
RA121P112	SENIOR PLUS 2P MFO SX AB	10"	1/2"	315	133	130
RA121P412	SENIOR PLUS 2P AFO SX AB	10"	3/4"	315	133	130
RA121P712	SENIOR PLUS 2P BFO SX AB	10"	1"	321	145	130

**HOUSINGS WITH PLASTIC BSP THREADS**

CODE	MODEL	SUITABLE CARTRIDGE	IN/OUT	DIMENSIONS mm		
				A	B	C
RA117P212	CADET PLUS 2P MFP SX AB	4"	1/2"	169	133	130
RA117P512	CADET PLUS 2P AFP SX AB	4"	3/4"	169	133	130
RA117P812	CADET PLUS 2P BFP SX AB	4"	1"	173	145	130
RA119P212	JUNIOR PLUS 2P MFP SX AB	7"	1/2"	241	133	130
RA119P512	JUNIOR PLUS 2P AFP SX AB	7"	3/4"	241	133	130
RA119P812	JUNIOR PLUS 2P BFP SX AB	7"	1"	247	145	130
RA121P212	SENIOR PLUS 2P MFP SX AB	10"	1/2"	315	133	130
RA121P512	SENIOR PLUS 2P AFP SX AB	10"	3/4"	315	133	130
RA121P812	SENIOR PLUS 2P BFP SX AB	10"	1"	321	145	130

**HOUSINGS WITH PLASTIC NPT THREADS**

CODE	MODEL	SUITABLE CARTRIDGE	IN/OUT	DIMENSIONS mm		
				A	B	C
RA117P517	CADET PLUS 2P AFP NPT SX AB	4"	3/4"	169	133	130
RA117P817	CADET PLUS 2P BFP NPT SX AB	4"	1"	173	145	130
RA119P517	JUNIOR PLUS 2P AFP NPT SX AB	7"	3/4"	241	133	130
RA119P817	JUNIOR PLUS 2P BFP NPT SX AB	7"	1"	247	145	130
RA121P517	SENIOR PLUS 2P AFP NPT SX AB	10"	3/4"	315	133	130
RA121P817	SENIOR PLUS 2P BFP NPT SX AB	10"	1"	321	145	130

**HOUSINGS WITH PLASTIC BSP THREADS**

CODE	MODEL	SUITABLE CARTRIDGE	IN/OUT	DIMENSIONS mm		
				A	B	C
RA117P215	CADET PLUS 2P MMP SX AB	4"	1/2"	169	175	130
RA117P515	CADET PLUS 2P AMP SX AB	4"	3/4"	169	175	130
RA117P815	CADET PLUS 2P BMP SX AB	4"	1"	173	175	130
RA119P215	JUNIOR PLUS 2P MMP SX AB	7"	1/2"	241	175	130
RA119P515	JUNIOR PLUS 2P AMP SX AB	7"	3/4"	241	175	130
RA119P815	JUNIOR PLUS 2P BMP SX AB	7"	1"	247	175	130
RA121P215	SENIOR PLUS 2P MMP SX AB	10"	1/2"	315	175	130
RA121P515	SENIOR PLUS 2P AMP SX AB	10"	3/4"	315	175	130
RA121P815	SENIOR PLUS 2P BMP SX AB	10"	1"	321	175	130

Some items in the list are subject to minimum order quantities and/or to longer delivery term.



# PLUS M 2P SX

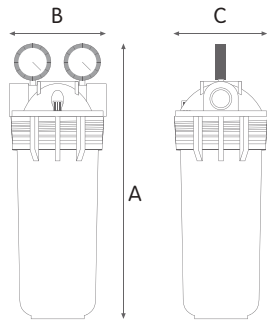

## WORKING CONDITIONS

Max working pressure \_\_\_\_\_ 8 bar (116 psi)  
 Max working temperature \_\_\_\_\_ 45°C (113°F)  
 Min working temperature \_\_\_\_\_ 4°C (39,2°F)

## SPECIFICATIONS

Non-toxic materials, suitable for drinking water.  
 Head: reinforced polypropylene.  
 Bowl: SAN.  
 O-ring: EPDM.  
 Breather-valve: body polypropylene, o-ring EPDM.  
 IN/OUT brass threads: CW 617 N brass.  
 Manometers: radial type, pressure range 0-12 bar, 0-170 psi.

## PLUS M 2P SX clear housings with 2 manometers

### HOUSINGS WITH BRASS BSP THREADS

CODE	MODEL	SUITABLE CARTRIDGE	IN/OUT	DIMENSIONS mm		
				A	B	C
RA117P114	CADET PLUS M 2P MFO SX AS	4"	1/2"	219	133	130
RA117P414	CADET PLUS M 2P AFO SX AS	4"	3/4"	219	133	130
RA117P714	CADET PLUS M 2P BFO SX AS	4"	1"	225	145	130
RA119P114	JUNIOR PLUS M 2P MFO SX AS	7"	1/2"	291	133	130
RA119P414	JUNIOR PLUS M 2P AFO SX AS	7"	3/4"	291	133	130
RA119P714	JUNIOR PLUS M 2P BFO SX AS	7"	1"	297	145	130
RA121P114	SENIOR PLUS M 2P MFO SX AS	10"	1/2"	365	133	130
RA121P414	SENIOR PLUS M 2P AFO SX AS	10"	3/4"	365	133	130
RA121P714	SENIOR PLUS M 2P BFO SX AS	10"	1"	371	145	130

### HOUSINGS WITH PLASTIC BSP THREADS

CODE	MODEL	SUITABLE CARTRIDGE	IN/OUT	DIMENSIONS mm		
				A	B	C
RA117P418	CADET PLUS M 2P AFP SX AS	4"	3/4"	219	133	130
RA117P718	CADET PLUS M 2P BFP SX AS	4"	1"	225	145	130
RA119P418	JUNIOR PLUS M 2P AFP SX AS	7"	3/4"	291	133	130
RA119P718	JUNIOR PLUS M 2P BFP SX AS	7"	1"	297	145	130
RA121P418	SENIOR PLUS M 2P AFP SX AS	10"	3/4"	365	133	130
RA121P718	SENIOR PLUS M 2P BFP SX AS	10"	1"	371	145	130

### HOUSINGS WITH PLASTIC NPT THREADS

CODE	MODEL	SUITABLE CARTRIDGE	IN/OUT	DIMENSIONS mm		
				A	B	C
RA117P518	CADET PLUS M 2P AFP NPT SX AS	4"	3/4"	219	133	130
RA117P818	CADET PLUS M 2P BFP NPT SX AS	4"	1"	225	145	130
RA119P518	JUNIOR PLUS M 2P AFP NPT SX AS	7"	3/4"	291	133	130
RA119P818	JUNIOR PLUS M 2P BFP NPT SX AS	7"	1"	297	145	130
RA121P518	SENIOR PLUS M 2P AFP NPT SX AS	10"	3/4"	365	133	130
RA121P818	SENIOR PLUS M 2P BFP NPT SX AS	10"	1"	371	145	130

Some items in the list are subject to minimum order quantities and/or to longer delivery term.



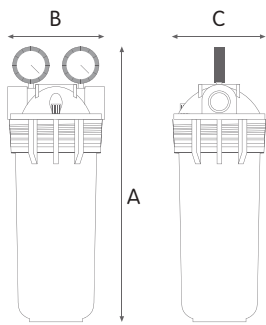

**WORKING CONDITIONS**

Max working pressure \_\_\_\_\_ 8 bar (116 psi)  
 Max working temperature \_\_\_\_\_ 45°C (113°F)  
 Min working temperature \_\_\_\_\_ 4°C (39,2°F)

**SPECIFICATIONS**

Non-toxic materials, suitable for drinking water.  
 Head: reinforced polypropylene.  
 Bowl: reinforced polypropylene.  
 O-ring: EPDM.  
 Breather-valve: body polypropylene, o-ring EPDM.  
 IN/OUT brass threads: CW 617 N brass.  
 Manometers: radial type, pressure range 0-12 bar, 0-170 psi.

**PLUS M 2P SX blue housings with 2 manometers**

**HOUSINGS WITH BRASS BSP THREADS**

CODE	MODEL	SUITABLE CARTRIDGE	IN/OUT	DIMENSIONS mm		
				A	B	C
RA117P115	CADET PLUS M 2P MFO SX AB	4"	1/2"	219	133	130
RA117P415	CADET PLUS M 2P AFO SX AB	4"	3/4"	219	133	130
RA117P715	CADET PLUS M 2P BFO SX AB	4"	1"	225	145	130
RA119P115	JUNIOR PLUS M 2P MFO SX AB	7"	1/2"	291	133	130
RA119P415	JUNIOR PLUS M 2P AFO SX AB	7"	3/4"	291	133	130
RA119P715	JUNIOR PLUS M 2P BFO SX AB	7"	1"	297	145	130
RA121P115	SENIOR PLUS M 2P MFO SX AB	10"	1/2"	365	133	130
RA121P415	SENIOR PLUS M 2P AFO SX AB	10"	3/4"	365	133	130
RA121P715	SENIOR PLUS M 2P BFO SX AB	10"	1"	371	145	130

**HOUSINGS WITH PLASTIC BSP THREADS**

CODE	MODEL	SUITABLE CARTRIDGE	IN/OUT	DIMENSIONS mm		
				A	B	C
RA117P419	CADET PLUS M 2P AFP SX AB	4"	3/4"	219	133	130
RA117P719	CADET PLUS M 2P BFP SX AB	4"	1"	225	145	130
RA119P419	JUNIOR PLUS M 2P AFP SX AB	7"	3/4"	291	133	130
RA119P719	JUNIOR PLUS M 2P BFP SX AB	7"	1"	297	145	130
RA121P419	SENIOR PLUS M 2P AFP SX AB	10"	3/4"	365	133	130
RA121P719	SENIOR PLUS M 2P BFP SX AB	10"	1"	371	145	130

**HOUSINGS WITH PLASTIC NPT THREADS**

CODE	MODEL	SUITABLE CARTRIDGE	IN/OUT	DIMENSIONS mm		
				A	B	C
RA117P519	CADET PLUS M 2P AFP NPT SX AB	4"	3/4"	219	133	130
RA117P819	CADET PLUS M 2P BFP NPT SX AB	4"	1"	225	145	130
RA119P519	JUNIOR PLUS M 2P AFP NPT SX AB	7"	3/4"	291	133	130
RA119P819	JUNIOR PLUS M 2P BFP NPT SX AB	7"	1"	297	145	130
RA121P519	SENIOR PLUS M 2P AFP NPT SX AB	10"	3/4"	365	133	130
RA121P819	SENIOR PLUS M 2P BFP NPT SX AB	10"	1"	371	145	130

Some items in the list are subject to minimum order quantities and/or to longer delivery term.



# DUPLEX PLUS 2P SX

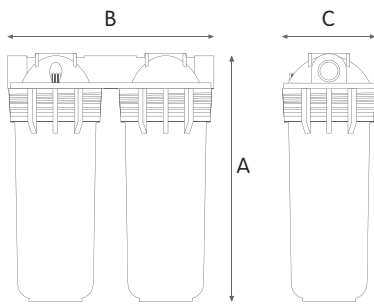

## WORKING CONDITIONS

Max working pressure \_\_\_\_\_ 8 bar (116 psi)  
 Max working temperature \_\_\_\_\_ 45°C (113°F)  
 Min working temperature \_\_\_\_\_ 4°C (39,2°F)

## SPECIFICATIONS

Non-toxic materials, suitable for drinking water.  
 Head: reinforced polypropylene.  
 Bowl: SAN.  
 O-ring: EPDM.  
 Breather-valve: body polypropylene, o-ring EPDM.  
 IN/OUT brass threads: CW 617 N brass.

## DUPLEX PLUS 2P SX clear housings

### HOUSINGS WITH BRASS BSP THREADS

CODE	MODEL	SUITABLE CARTRIDGE	IN/OUT	DIMENSIONS mm		
				A	B	C
RA118P411	CADET DUPLEX PLUS 2P AFO SX AS	4"	3/4"	169	275	130
RA118P711	CADET DUPLEX PLUS 2P BFO SX AS	4"	1"	169	275	130
RA120P411	JUNIOR DUPLEX PLUS 2P AFO SX AS	7"	3/4"	241	275	130
RA120P711	JUNIOR DUPLEX PLUS 2P BFO SX AS	7"	1"	241	275	130
RA122P411	SENIOR DUPLEX PLUS 2P AFO SX AS	10"	3/4"	315	275	130
RA122P711	SENIOR DUPLEX PLUS 2P BFO SX AS	10"	1"	315	275	130

### HOUSINGS WITH PLASTIC BSP THREADS

CODE	MODEL	SUITABLE CARTRIDGE	IN/OUT	DIMENSIONS mm		
				A	B	C
RA118P511	CADET DUPLEX PLUS 2P AFP SX AS	4"	3/4"	169	275	130
RA120P511	JUNIOR DUPLEX PLUS 2P AFP SX AS	7"	3/4"	241	275	130
RA122P511	SENIOR DUPLEX PLUS 2P AFP SX AS	10"	3/4"	315	275	130

### HOUSINGS WITH PLASTIC NPT THREADS

CODE	MODEL	SUITABLE CARTRIDGE	IN/OUT	DIMENSIONS mm		
				A	B	C
RA118P513	CADET DUPLEX PLUS 2P AFP NPT SX AS	4"	3/4"	169	275	130
RA120P513	JUNIOR DUPLEX PLUS 2P AFP NPT SX AS	7"	3/4"	241	275	130
RA122P513	SENIOR DUPLEX PLUS 2P AFP NPT SX AS	10"	3/4"	315	275	130

Some items in the list are subject to minimum order quantities and/or to longer delivery term.

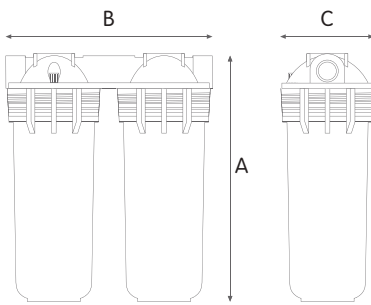

**WORKING CONDITIONS**

Max working pressure \_\_\_\_\_ 8 bar (116 psi)  
 Max working temperature \_\_\_\_\_ 45°C (113°F)  
 Min working temperature \_\_\_\_\_ 4°C (39,2°F)

**SPECIFICATIONS**

Non-toxic materials, suitable for drinking water.  
 Head: reinforced polypropylene.  
 Bowl: reinforced polypropylene.  
 O-ring: EPDM.  
 Breather-valve: body polypropylene, o-ring EPDM.  
 IN/OUT brass threads: CW 617 N brass.

**DUPLEX PLUS 2P SX blue housings**

**HOUSINGS WITH BRASS BSP THREADS**

CODE	MODEL	SUITABLE CARTRIDGE	IN/OUT	DIMENSIONS mm		
				A	B	C
RA118P412	CADET DUPLEX PLUS 2P AFO SX AB	4"	3/4"	169	275	130
RA118P712	CADET DUPLEX PLUS 2P BFO SX AB	4"	1"	169	275	130
RA120P412	JUNIOR DUPLEX PLUS 2P AFO SX AB	7"	3/4"	241	275	130
RA120P712	JUNIOR DUPLEX PLUS 2P BFO SX AB	7"	1"	241	275	130
RA122P412	SENIOR DUPLEX PLUS 2P AFO SX AB	10"	3/4"	315	275	130
RA122P712	SENIOR DUPLEX PLUS 2P BFO SX AB	10"	1"	315	275	130

**HOUSINGS WITH PLASTIC BSP THREADS**

CODE	MODEL	SUITABLE CARTRIDGE	IN/OUT	DIMENSIONS mm		
				A	B	C
RA118P512	CADET DUPLEX PLUS 2P AFP SX AB	4"	3/4"	169	275	130
RA120P512	JUNIOR DUPLEX PLUS 2P AFP SX AB	7"	3/4"	241	275	130
RA122P512	SENIOR DUPLEX PLUS 2P AFP SX AB	10"	3/4"	315	275	130

**HOUSINGS WITH PLASTIC NPT THREADS**

CODE	MODEL	SUITABLE CARTRIDGE	IN/OUT	DIMENSIONS mm		
				A	B	C
RA118P514	CADET DUPLEX PLUS 2P AFP NPT SX AB	4"	3/4"	169	275	130
RA120P514	JUNIOR DUPLEX PLUS 2P AFP NPT SX AB	7"	3/4"	241	275	130
RA122P514	SENIOR DUPLEX PLUS 2P AFP NPT SX AB	10"	3/4"	315	275	130

Some items in the list are subject to minimum order quantities and/or to longer delivery term.



# TRIPLEX PLUS 2P SX

## WORKING CONDITIONS

Max working pressure \_\_\_\_\_ 8 bar (116 psi)  
 Max working temperature \_\_\_\_\_ 45°C (113°F)  
 Min working temperature \_\_\_\_\_ 4°C (39,2°F)

## SPECIFICATIONS

Non-toxic materials, suitable for drinking water.  
 Head: reinforced polypropylene.  
 Bowl: SAN.  
 O-ring: EPDM.  
 Breather-valve: body polypropylene, o-ring EPDM.  
 IN/OUT brass threads: CW 617 N brass.

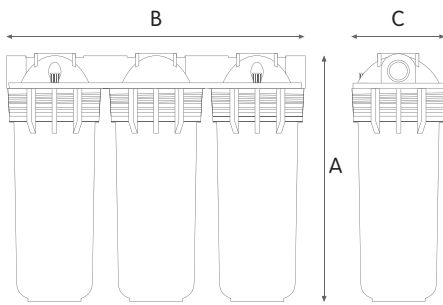

## TRIPLEX PLUS 2P SX clear housings

### HOUSINGS WITH BRASS BSP THREADS

CODE	MODEL	SUITABLE CARTRIDGE	IN/OUT	DIMENSIONS mm		
				A	B	C
RA118P431	CADET TRIPLEX PLUS 2P AFO SX AS	4"	3/4"	169	420	130
RA118P731	CADET TRIPLEX PLUS 2P BFO SX AS	4"	1"	169	420	130
RA120P431	JUNIOR TRIPLEX PLUS 2P AFO SX AS	7"	3/4"	241	420	130
RA120P731	JUNIOR TRIPLEX PLUS 2P BFO SX AS	7"	1"	241	420	130
RA122P431	SENIOR TRIPLEX PLUS 2P AFO SX AS	10"	3/4"	315	420	130
RA122P731	SENIOR TRIPLEX PLUS 2P BFO SX AS	10"	1"	315	420	130

### HOUSINGS WITH PLASTIC BSP THREADS

CODE	MODEL	SUITABLE CARTRIDGE	IN/OUT	DIMENSIONS mm		
				A	B	C
RA118P531	CADET TRIPLEX PLUS 2P AFP SX AS	4"	3/4"	169	420	130
RA118P831	CADET TRIPLEX PLUS 2P BFP SX AS	4"	1"	169	420	130
RA120P531	JUNIOR TRIPLEX PLUS 2P AFP SX AS	7"	3/4"	241	420	130
RA120P831	JUNIOR TRIPLEX PLUS 2P BFP SX AS	7"	1"	241	420	130
RA122P531	SENIOR TRIPLEX PLUS 2P AFP SX AS	10"	3/4"	315	420	130
RA122P831	SENIOR TRIPLEX PLUS 2P BFP SX AS	10"	1"	315	420	130

### HOUSINGS WITH PLASTIC NPT THREADS

CODE	MODEL	SUITABLE CARTRIDGE	IN/OUT	DIMENSIONS mm		
				A	B	C
RA118P533	CADET TRIPLEX PLUS 2P AFP NPT SX AS	4"	3/4"	169	420	130
RA120P533	JUNIOR TRIPLEX PLUS 2P AFP NPT SX AS	7"	3/4"	241	420	130
RA122P533	SENIOR TRIPLEX PLUS 2P AFP NPT SX AS	10"	3/4"	315	420	130

Some items in the list are subject to minimum order quantities and/or to longer delivery term.

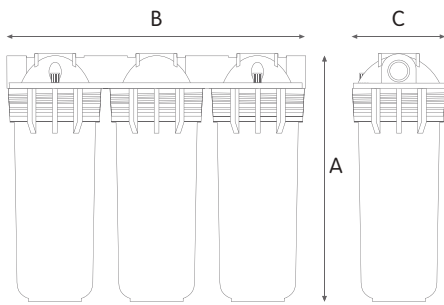

**WORKING CONDITIONS**

Max working pressure \_\_\_\_\_ 8 bar (116 psi)  
 Max working temperature \_\_\_\_\_ 45°C (113°F)  
 Min working temperature \_\_\_\_\_ 4°C (39,2°F)

**SPECIFICATIONS**

Non-toxic materials, suitable for drinking water.  
 Head: reinforced polypropylene.  
 Bowl: reinforced polypropylene.  
 O-ring: EPDM.  
 Breather-valve: body polypropylene, o-ring EPDM.  
 IN/OUT brass threads: CW 617 N brass.

**TRIPLEX PLUS 2P SX blue housings**

**HOUSINGS WITH BRASS BSP THREADS**

CODE	MODEL	SUITABLE CARTRIDGE	IN/OUT	DIMENSIONS mm		
				A	B	C
RA118P432	CADET TRIPLEX PLUS 2P AFO SX AB	4"	3/4"	169	420	130
RA118P732	CADET TRIPLEX PLUS 2P BFO SX AB	4"	1"	169	420	130
RA120P432	JUNIOR TRIPLEX PLUS 2P AFO SX AB	7"	3/4"	241	420	130
RA120P732	JUNIOR TRIPLEX PLUS 2P BFO SX AB	7"	1"	241	420	130
RA122P432	SENIOR TRIPLEX PLUS 2P AFO SX AB	10"	3/4"	315	420	130
RA122P732	SENIOR TRIPLEX PLUS 2P BFO SX AB	10"	1"	315	420	130

**HOUSINGS WITH PLASTIC BSP THREADS**

CODE	MODEL	SUITABLE CARTRIDGE	IN/OUT	DIMENSIONS mm		
				A	B	C
RA118P532	CADET TRIPLEX PLUS 2P AFP SX AB	4"	3/4"	169	420	130
RA118P832	CADET TRIPLEX PLUS 2P BFP SX AB	4"	1"	169	420	130
RA120P532	JUNIOR TRIPLEX PLUS 2P AFP SX AB	7"	3/4"	241	420	130
RA120P832	JUNIOR TRIPLEX PLUS 2P BFP SX AB	7"	1"	241	420	130
RA122P532	SENIOR TRIPLEX PLUS 2P AFP SX AB	10"	3/4"	315	420	130
RA122P832	SENIOR TRIPLEX PLUS 2P BFP SX AB	10"	1"	315	420	130

**HOUSINGS WITH PLASTIC NPT THREADS**

CODE	MODEL	SUITABLE CARTRIDGE	IN/OUT	DIMENSIONS mm		
				A	B	C
RA118P534	CADET TRIPLEX PLUS 2P AFP NPT SX AB	4"	3/4"	169	420	130
RA120P534	JUNIOR TRIPLEX PLUS 2P AFP NPT SX AB	7"	3/4"	241	420	130
RA122P534	SENIOR TRIPLEX PLUS 2P AFP NPT SX AB	10"	3/4"	315	420	130

Some items in the list are subject to minimum order quantities and/or to longer delivery term.







## PLUS 3P

filter housings for cartridges BX and CX

Range of housings designed to fit  
to exclusive BX cartridges with 45 mm double o-ring collar  
and to exclusive CX cartridges with 57 mm double o-ring collar.

# HOUSINGS PLUS 3P

FOR CARTRIDGES BX and CX

**Housings PLUS 3P BX fit to exclusive BX cartridges with 45 mm double o-ring collar,** available as single, DUPLEX and TRIPLEX models.

**Housings PLUS 3P CX fit to exclusive CX cartridges with 57 mm double o-ring collar.**

A very wide range of Atlas Filtri® BX and CX cartridges is available for 3P PLUS BX and CX housings and provide a complete range of water filtration and treatment units.

**Housings PLUS S 3P BX and housings PLUS S 3P CX with discharge valve** are provided with a drain funnel to protect potable water from pollution by back-flow, in compliance with **UNI EN 1717-11/2002**. S models can be used with KIT AUTO for automatic flushing and self-cleaning.



**BX** cartridges with 45 mm double o-ring collar. Quick-fit connection for a perfect tightening.



**CX** cartridges with 57 mm double o-ring collar. Quick-fit connection for a perfect tightening and designed to suit to large water flow.

PLUS 3P BX and PLUS 3P CX housings are suitable for every Point-of-Entry (POE) application, as single or multi-stage on-line filters.

## CERTIFICATIONS



A range of housings is certified by IAPMO RT to NSF/ANSI 42, 61, 372 - lead free, CSA B483.1. In compliance with Drinking Water Treatment Units regulations, USA and Canada.



Housings are tested and certified under the most stringent procedures worldwide, in compliance with DM 25 (Italy), with the sanitary certification ACS (France), EAC/Ghostregistrazia (Russia) and WaterMark (Australia).

## ACCESSORY INCLUDED

### DISCHARGE KIT FOR -S- MODELS

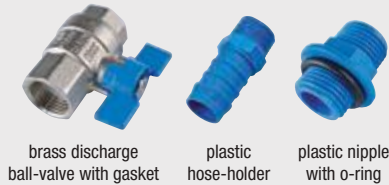

brass discharge ball-valve with gasket    plastic hose-holder    plastic nipple with o-ring



drain funnel

In compliance with the European Standard UNI EN 1717/2002: designed to prevent back-flow contamination by making all elements downstream the discharge vent to atmosphere (protection unit symbol: DC)

## SYMBOLS LEGEND



For domestic use



For technical and industrial use



Filter housings made in PET, a highly recyclable plastic, are manufactured with a proprietary procedure saving up to 60% of energy in injection molding compared with standard plastics. That is one of Atlas Filtri commitments for the reduction of green house gas (CO<sub>2</sub>) emissions in the atmosphere.

## ACCESSORIES ON DEMAND



-U- spanner CODE RB7403013



-S- wall bracket CODE RB7400007



-D- wall bracket CODE RB7400009



-T- wall bracket CODE RB7401010



3/4" brass nipples with o-ring (pair) CODE RB7404001

1" brass nipples with o-ring (pair) CODE RB7404002



3/4" plastic nipple with o-ring CODE LB7404012



3/4"-1/4" plastic reduction with o-ring CODE LB9020611



-KIT AUTO- for S models CODE RE7120024  
automatic discharge kit (see pages 186-187)



-LUBRIKIT- single-dose lubricant for housing o-ring  
CODE RE9020650

HOUSINGS RANGE



SENIOR	PLUS	3P	A	FO	BX	TS
HOUSINGS MODEL	VERSION	IN / OUT	THREADS TYPE	CARTRIDGE TYPE	BOWL TYPE	
MEDIUM DUPLEX	PLUS	M 1/2"	FO - BRASS BSP *	BX - QUICK-FIT DOUBLE O-RING 45 mm	TS - CLEAR (PET)	
JUNIOR DUPLEX	PLUS M	A 3/4"	FP - PLASTIC BSP *	CX - QUICK-FIT DOUBLE O-RING 57 mm	AB - BLUE (PET)	
SENIOR DUPLEX	PLUS S	B 1"	FP-NPT - PLASTIC NPT **			
MASTER DUPLEX	PLUS S M	D 1 1/4"	MP - PLASTIC BSP *			
MEDIUM TRIPLEX		E 1 1/2"				
JUNIOR TRIPLEX		F 2"				
SENIOR TRIPLEX						
MASTER TRIPLEX						

**\* BSP**  
parallel (cylindrical)  
ISO 228

**\*\* NPT**  
tapered (conical)  
ANSI/ASME B1.20.1



# PLUS 3P BX

## WORKING CONDITIONS

Max working pressure:  
 BSP versions \_\_\_\_\_ 8 bar (116 psi)  
 NPT versions \_\_\_\_\_ 8,6 bar (125 psi)  
 Max working temperature \_\_\_\_\_ 45°C (113°F)  
 Min working temperature \_\_\_\_\_ 4°C (39,2°F)

## SPECIFICATIONS

Non-toxic materials, suitable for drinking water.  
 Head and ring nut: reinforced polypropylene.  
 Bowl: PET.  
 O-ring: EPDM.  
 Breather-valve: body polypropylene, o-ring EPDM.  
 IN/OUT brass threads: CW 617 N brass.

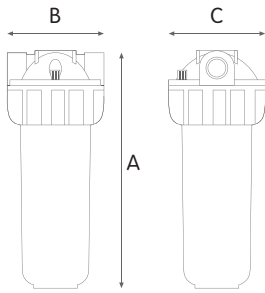

## PLUS 3P BX clear housings

### HOUSINGS WITH BRASS BSP THREADS

CODE	MODEL	SUITABLE CARTRIDGE	IN/OUT	DIMENSIONS mm		
				A	B	C
RA107T121	MEDIUM PLUS 3P MFO BX TS	5"	1/2"	191	133	130
RA107T421	MEDIUM PLUS 3P AFO BX TS	5"	3/4"	191	133	130
RA107T721	MEDIUM PLUS 3P BFO BX TS	5"	1"	197	145	130
RA109T121	JUNIOR PLUS 3P MFO BX TS	7"	1/2"	241	133	130
RA109T421	JUNIOR PLUS 3P AFO BX TS	7"	3/4"	241	133	130
RA109T721	JUNIOR PLUS 3P BFO BX TS	7"	1"	247	145	130
RA111T121	SENIOR PLUS 3P MFO BX TS	10"	1/2"	315	133	130
RA111T421	SENIOR PLUS 3P AFO BX TS	10"	3/4"	315	133	130
RA111T721	SENIOR PLUS 3P BFO BX TS	10"	1"	321	145	130
RA115T121	MASTER PLUS 3P MFO BX TS	20"	1/2"	571	133	130
RA115T421	MASTER PLUS 3P AFO BX TS	20"	3/4"	571	133	130
RA115T721	MASTER PLUS 3P BFO BX TS	20"	1"	577	145	130

### HOUSINGS WITH PLASTIC BSP THREADS

CODE	MODEL	SUITABLE CARTRIDGE	IN/OUT	DIMENSIONS mm		
				A	B	C
RA107T221	MEDIUM PLUS 3P MFP BX TS	5"	1/2"	191	133	130
RA107T521	MEDIUM PLUS 3P AFP BX TS	5"	3/4"	191	133	130
RA107T821	MEDIUM PLUS 3P BFP BX TS	5"	1"	197	145	130
RA109T221	JUNIOR PLUS 3P MFP BX TS	7"	1/2"	241	133	130
RA109T521	JUNIOR PLUS 3P AFP BX TS	7"	3/4"	241	133	130
RA109T821	JUNIOR PLUS 3P BFP BX TS	7"	1"	247	145	130
RA111T221	SENIOR PLUS 3P MFP BX TS	10"	1/2"	315	133	130
RA111T521	SENIOR PLUS 3P AFP BX TS	10"	3/4"	315	133	130
RA111T821	SENIOR PLUS 3P BFP BX TS	10"	1"	321	145	130
RA115T221	MASTER PLUS 3P MFP BX TS	20"	1/2"	571	133	130
RA115T521	MASTER PLUS 3P AFP BX TS	20"	3/4"	571	133	130
RA115T821	MASTER PLUS 3P BFP BX TS	20"	1"	577	145	130

### HOUSINGS WITH PLASTIC NPT THREADS

CODE	MODEL	SUITABLE CARTRIDGE	IN/OUT	DIMENSIONS mm		
				A	B	C
RA107T523	MEDIUM PLUS 3P AFP NPT BX TS	5"	3/4"	191	133	130
RA107T823	MEDIUM PLUS 3P BFP NPT BX TS	5"	1"	197	145	130
RA109T523	JUNIOR PLUS 3P AFP NPT BX TS	7"	3/4"	241	133	130
RA109T823	JUNIOR PLUS 3P BFP NPT BX TS	7"	1"	247	145	130
RA111T621	SENIOR PLUS 3P AFP NPT BX TS	10"	3/4"	315	133	130
RA111T823	SENIOR PLUS 3P BFP NPT BX TS	10"	1"	321	145	130
RA115T523	MASTER PLUS 3P AFP NPT BX TS	20"	3/4"	571	133	130
RA115T823	MASTER PLUS 3P BFP NPT BX TS	20"	1"	577	145	130

### HOUSINGS WITH PLASTIC BSP THREADS

CODE	MODEL	SUITABLE CARTRIDGE	IN/OUT	DIMENSIONS mm		
				A	B	C
RA107T225	MEDIUM PLUS 3P MMP BX TS	5"	1/2"	191	175	130
RA107T525	MEDIUM PLUS 3P AMP BX TS	5"	3/4"	191	175	130
RA107T825	MEDIUM PLUS 3P BMP BX TS	5"	1"	197	175	130
RA109T225	JUNIOR PLUS 3P MMP BX TS	7"	1/2"	241	175	130
RA109T525	JUNIOR PLUS 3P AMP BX TS	7"	3/4"	241	175	130
RA109T825	JUNIOR PLUS 3P BMP BX TS	7"	1"	247	175	130
RA111T225	SENIOR PLUS 3P MMP BX TS	10"	1/2"	315	175	130
RA111T525	SENIOR PLUS 3P AMP BX TS	10"	3/4"	315	175	130
RA111T825	SENIOR PLUS 3P BMP BX TS	10"	1"	321	175	130
RA115T225	MASTER PLUS 3P MMP BX TS	20"	1/2"	571	175	130
RA115T525	MASTER PLUS 3P AMP BX TS	20"	3/4"	571	175	130
RA115T828	MASTER PLUS 3P BMP BX TS	20"	1"	577	175	130

Some items in the list are subject to minimum order quantities and/or to longer delivery term.



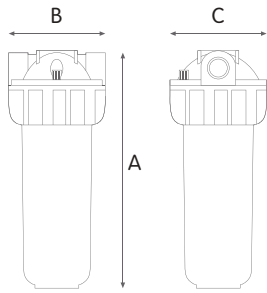

**WORKING CONDITIONS**

Max working pressure:  
 BSP versions \_\_\_\_\_ 8 bar (116 psi)  
 NPT versions \_\_\_\_\_ 8,6 bar (125 psi)  
 Max working temperature \_\_\_\_\_ 45°C (113°F)  
 Min working temperature \_\_\_\_\_ 4°C (39,2°F)

**SPECIFICATIONS**

Non-toxic materials, suitable for drinking water.  
 Head and ring nut: reinforced polypropylene.  
 Bowl: PET.  
 O-ring: EPDM.  
 Breather-valve: body polypropylene, o-ring EPDM.  
 IN/OUT brass threads: CW 617 N brass.

**PLUS 3P BX blue housings**

**HOUSINGS WITH BRASS BSP THREADS**

CODE	MODEL	SUITABLE CARTRIDGE	IN/OUT	DIMENSIONS mm		
				A	B	C
RA107T122	MEDIUM PLUS 3P MFO BX AB	5"	1/2"	191	133	130
RA107T422	MEDIUM PLUS 3P AFO BX AB	5"	3/4"	191	133	130
RA107T722	MEDIUM PLUS 3P BFO BX AB	5"	1"	197	145	130
RA109T122	JUNIOR PLUS 3P MFO BX AB	7"	1/2"	241	133	130
RA109T422	JUNIOR PLUS 3P AFO BX AB	7"	3/4"	241	133	130
RA109T722	JUNIOR PLUS 3P BFO BX AB	7"	1"	247	145	130
RA111T122	SENIOR PLUS 3P MFO BX AB	10"	1/2"	315	133	130
RA111T422	SENIOR PLUS 3P AFO BX AB	10"	3/4"	315	133	130
RA111T722	SENIOR PLUS 3P BFO BX AB	10"	1"	321	145	130
RA115T122	MASTER PLUS 3P MFO BX AB	20"	1/2"	571	133	130
RA115T422	MASTER PLUS 3P AFO BX AB	20"	3/4"	571	133	130
RA115T722	MASTER PLUS 3P BFO BX AB	20"	1"	577	145	130

**HOUSINGS WITH PLASTIC BSP THREADS**

CODE	MODEL	SUITABLE CARTRIDGE	IN/OUT	DIMENSIONS mm		
				A	B	C
RA107T222	MEDIUM PLUS 3P MFP BX AB	5"	1/2"	191	133	130
RA107T522	MEDIUM PLUS 3P AFP BX AB	5"	3/4"	191	133	130
RA107T822	MEDIUM PLUS 3P BFP BX AB	5"	1"	197	145	130
RA109T222	JUNIOR PLUS 3P MFP BX AB	7"	1/2"	241	133	130
RA109T522	JUNIOR PLUS 3P AFP BX AB	7"	3/4"	241	133	130
RA109T822	JUNIOR PLUS 3P BFP BX AB	7"	1"	247	145	130
RA111T222	SENIOR PLUS 3P MFP BX AB	10"	1/2"	315	133	130
RA111T522	SENIOR PLUS 3P AFP BX AB	10"	3/4"	315	133	130
RA111T822	SENIOR PLUS 3P BFP BX AB	10"	1"	321	145	130
RA115T222	MASTER PLUS 3P MFP BX AB	20"	1/2"	571	133	130
RA115T522	MASTER PLUS 3P AFP BX AB	20"	3/4"	571	133	130
RA115T822	MASTER PLUS 3P BFP BX AB	20"	1"	577	145	130

**HOUSINGS WITH PLASTIC NPT THREADS**

CODE	MODEL	SUITABLE CARTRIDGE	IN/OUT	DIMENSIONS mm		
				A	B	C
RA107T524	MEDIUM PLUS 3P AFP NPT BX AB	5"	3/4"	191	133	130
RA107T824	MEDIUM PLUS 3P BFP NPT BX AB	5"	1"	197	145	130
RA109T524	JUNIOR PLUS 3P AFP NPT BX AB	7"	3/4"	241	133	130
RA109T824	JUNIOR PLUS 3P BFP NPT BX AB	7"	1"	247	145	130
RA111T622	SENIOR PLUS 3P AFP NPT BX AB	10"	3/4"	315	133	130
RA111T824	SENIOR PLUS 3P BFP NPT BX AB	10"	1"	321	145	130
RA115T622	MASTER PLUS 3P AFP NPT BX AB	20"	3/4"	571	133	130
RA115T824	MASTER PLUS 3P BFP NPT BX AB	20"	1"	577	145	130

**HOUSINGS WITH PLASTIC BSP THREADS**

CODE	MODEL	SUITABLE CARTRIDGE	IN/OUT	DIMENSIONS mm		
				A	B	C
RA107T226	MEDIUM PLUS 3P MMP BX AB	5"	1/2"	191	175	130
RA107T526	MEDIUM PLUS 3P AMP BX AB	5"	3/4"	191	175	130
RA107T826	MEDIUM PLUS 3P BMP BX AB	5"	1"	197	175	130
RA109T226	JUNIOR PLUS 3P MMP BX AB	7"	1/2"	241	175	130
RA109T526	JUNIOR PLUS 3P AMP BX AB	7"	3/4"	241	175	130
RA109T826	JUNIOR PLUS 3P BMP BX AB	7"	1"	247	175	130
RA111T226	SENIOR PLUS 3P MMP BX AB	10"	1/2"	315	175	130
RA111T526	SENIOR PLUS 3P AMP BX AB	10"	3/4"	315	175	130
RA111T828	SENIOR PLUS 3P BMP BX AB	10"	1"	321	175	130
RA115T226	MASTER PLUS 3P MMP BX AB	20"	1/2"	571	175	130
RA115T526	MASTER PLUS 3P AMP BX AB	20"	3/4"	571	175	130
RA115T829	MASTER PLUS 3P BMP BX AB	20"	1"	577	175	130

Some items in the list are subject to minimum order quantities and/or to longer delivery term.





# PLUS M 3P BX

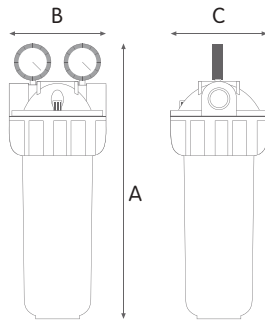

## WORKING CONDITIONS

Max working pressure:  
 BSP versions \_\_\_\_\_ 8 bar (116 psi)  
 NPT versions \_\_\_\_\_ 8,6 bar (125 psi)  
 Max working temperature \_\_\_\_\_ 45°C (113°F)  
 Min working temperature \_\_\_\_\_ 4°C (39,2°F)

## SPECIFICATIONS

Non-toxic materials, suitable for drinking water.  
 Head and ring nut: reinforced polypropylene.  
 Bowl: PET.  
 O-ring: EPDM.  
 Breather-valve: body polypropylene, o-ring EPDM.  
 IN/OUT brass threads: CW 617 N brass.  
 Manometers: radial type, pressure range 0-12 bar, 0-170 psi.

## PLUS M 3P BX clear housings with 2 manometers

### HOUSINGS WITH BRASS BSP THREADS

CODE	MODEL	SUITABLE CARTRIDGE	IN/OUT	DIMENSIONS mm		
				A	B	C
RA107T124	MEDIUM PLUS M 3P MFO BX TS	5"	1/2"	241	133	130
RA107T424	MEDIUM PLUS M 3P AFO BX TS	5"	3/4"	241	133	130
RA107T724	MEDIUM PLUS M 3P BFO BX TS	5"	1"	247	145	130
RA109T124	JUNIOR PLUS M 3P MFO BX TS	7"	1/2"	291	133	130
RA109T424	JUNIOR PLUS M 3P AFO BX TS	7"	3/4"	291	133	130
RA109T724	JUNIOR PLUS M 3P BFO BX TS	7"	1"	297	145	130
RA111T124	SENIOR PLUS M 3P MFO BX TS	10"	1/2"	365	133	130
RA111T424	SENIOR PLUS M 3P AFO BX TS	10"	3/4"	365	133	130
RA111T724	SENIOR PLUS M 3P BFO BX TS	10"	1"	371	145	130
RA115T124	MASTER PLUS M 3P MFO BX TS	20"	1/2"	621	133	130
RA115T424	MASTER PLUS M 3P AFO BX TS	20"	3/4"	621	133	130
RA115T724	MASTER PLUS M 3P BFO BX TS	20"	1"	627	145	130

### HOUSINGS WITH PLASTIC BSP THREADS

CODE	MODEL	SUITABLE CARTRIDGE	IN/OUT	DIMENSIONS mm		
				A	B	C
RA107T428	MEDIUM PLUS M 3P AFP BX TS	5"	3/4"	241	133	130
RA107T728	MEDIUM PLUS M 3P BFP BX TS	5"	1"	247	145	130
RA109T428	JUNIOR PLUS M 3P AFP BX TS	7"	3/4"	291	133	130
RA109T728	JUNIOR PLUS M 3P BFP BX TS	7"	1"	297	145	130
RA111T423	SENIOR PLUS M 3P AFP BX TS	10"	3/4"	365	133	130
RA111T728	SENIOR PLUS M 3P BFP BX TS	10"	1"	371	145	130
RA115T423	MASTER PLUS M 3P AFP BX TS	20"	3/4"	621	133	130
RA115T728	MASTER PLUS M 3P BFP BX TS	20"	1"	627	145	130

### HOUSINGS WITH PLASTIC NPT THREADS

CODE	MODEL	SUITABLE CARTRIDGE	IN/OUT	DIMENSIONS mm		
				A	B	C
RA107T426	MEDIUM PLUS M 3P AFP NPT BX TS	5"	3/4"	241	133	130
RA107T726	MEDIUM PLUS M 3P BFP NPT BX TS	5"	1"	247	145	130
RA109T426	JUNIOR PLUS M 3P AFP NPT BX TS	7"	3/4"	291	133	130
RA109T726	JUNIOR PLUS M 3P BFP NPT BX TS	7"	1"	297	145	130
RA111T426	SENIOR PLUS M 3P AFP NPT BX TS	10"	3/4"	365	133	130
RA111T826	SENIOR PLUS M 3P BFP NPT BX TS	10"	1"	371	145	130
RA115T426	MASTER PLUS M 3P AFP NPT BX TS	20"	3/4"	621	133	130
RA115T826	MASTER PLUS M 3P BFP NPT BX TS	20"	1"	627	145	130

Some items in the list are subject to minimum order quantities and/or to longer delivery term.

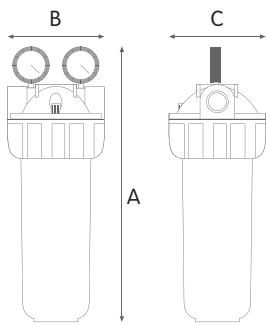

**WORKING CONDITIONS**

Max working pressure:  
 BSP versions \_\_\_\_\_ 8 bar (116 psi)  
 NPT versions \_\_\_\_\_ 8,6 bar (125 psi)  
 Max working temperature \_\_\_\_\_ 45°C (113°F)  
 Min working temperature \_\_\_\_\_ 4°C (39,2°F)

**SPECIFICATIONS**

Non-toxic materials, suitable for drinking water.  
 Head and ring nut: reinforced polypropylene.  
 Bowl: PET.  
 O-ring: EPDM.  
 Breather-valve: body polypropylene, o-ring EPDM.  
 IN/OUT brass threads: CW 617 N brass.  
 Manometers: radial type, pressure range 0-12 bar, 0-170 psi.

**PLUS M 3P BX blue housings with 2 manometers**

**HOUSINGS WITH BRASS BSP THREADS**

CODE	MODEL	SUITABLE CARTRIDGE	IN/OUT	DIMENSIONS mm		
				A	B	C
RA107T125	MEDIUM PLUS M 3P MFO BX AB	5"	1/2"	241	133	130
RA107T425	MEDIUM PLUS M 3P AFO BX AB	5"	3/4"	241	133	130
RA107T725	MEDIUM PLUS M 3P BFO BX AB	5"	1"	247	145	130
RA109T125	JUNIOR PLUS M 3P MFO BX AB	7"	1/2"	291	133	130
RA109T425	JUNIOR PLUS M 3P AFO BX AB	7"	3/4"	291	133	130
RA109T725	JUNIOR PLUS M 3P BFO BX AB	7"	1"	297	145	130
RA111T125	SENIOR PLUS M 3P MFO BX AB	10"	1/2"	365	133	130
RA111T425	SENIOR PLUS M 3P AFO BX AB	10"	3/4"	365	133	130
RA111T725	SENIOR PLUS M 3P BFO BX AB	10"	1"	371	145	130
RA115T125	MASTER PLUS M 3P MFO BX AB	20"	1/2"	621	133	130
RA115T425	MASTER PLUS M 3P AFO BX AB	20"	3/4"	621	133	130
RA115T825	MASTER PLUS M 3P BFO BX AB	20"	1"	627	145	130

**HOUSINGS WITH PLASTIC BSP THREADS**

CODE	MODEL	SUITABLE CARTRIDGE	IN/OUT	DIMENSIONS mm		
				A	B	C
RA107T429	MEDIUM PLUS M 3P AFP BX AB	5"	3/4"	241	133	130
RA107T729	MEDIUM PLUS M 3P BFP BX AB	5"	1"	247	145	130
RA109T429	JUNIOR PLUS M 3P AFP BX AB	7"	3/4"	291	133	130
RA109T729	JUNIOR PLUS M 3P BFP BX AB	7"	1"	297	145	130
RA111T429	SENIOR PLUS M 3P AFP BX AB	10"	3/4"	365	133	130
RA111T729	SENIOR PLUS M 3P BFP BX AB	10"	1"	371	145	130
RA115T429	MASTER PLUS M 3P AFP BX AB	20"	3/4"	621	133	130
RA115T729	MASTER PLUS M 3P BFP BX AB	20"	1"	627	145	130

**HOUSINGS WITH PLASTIC NPT THREADS**

CODE	MODEL	SUITABLE CARTRIDGE	IN/OUT	DIMENSIONS mm		
				A	B	C
RA107T427	MEDIUM PLUS M 3P AFP NPT BX AB	5"	3/4"	241	133	130
RA107T727	MEDIUM PLUS M 3P BFP NPT BX AB	5"	1"	247	145	130
RA109T427	JUNIOR PLUS M 3P AFP NPT BX AB	7"	3/4"	291	133	130
RA109T727	JUNIOR PLUS M 3P BFP NPT BX AB	7"	1"	297	145	130
RA111T427	SENIOR PLUS M 3P AFP NPT BX AB	10"	3/4"	365	133	130
RA111T727	SENIOR PLUS M 3P BFP NPT BX AB	10"	1"	371	145	130
RA115T427	MASTER PLUS M 3P AFP NPT BX AB	20"	3/4"	621	133	130
RA115T827	MASTER PLUS M 3P BFP NPT BX AB	20"	1"	627	145	130

Some items in the list are subject to minimum order quantities and/or to longer delivery term.



# PLUS S 3P BX

## WORKING CONDITIONS

Max working pressure:  
 BSP versions \_\_\_\_\_ 8 bar (116 psi)  
 NPT versions \_\_\_\_\_ 8,6 bar (125 psi)  
 Max working temperature \_\_\_\_\_ 45°C (113°F)  
 Min working temperature \_\_\_\_\_ 4°C (39,2°F)

## SPECIFICATIONS

Non-toxic materials, suitable for drinking water.  
 Head and ring nut: reinforced polypropylene.  
 Bowl: PET.  
 O-ring: EPDM.  
 Breather-valve: body polypropylene, o-ring EPDM.  
 IN/OUT brass threads: CW 617 N brass.  
 Discharge ball-valve: CW 617 N brass nickel plated.  
 Discharge plastic nipple: reinforced polypropylene.  
 Drain funnel: reinforced polypropylene.

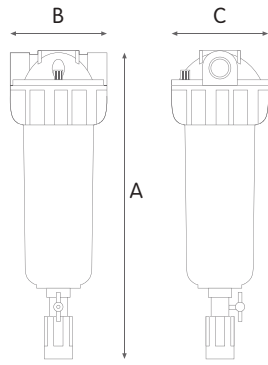

**DRAIN FUNNEL**  
 Back-flow preventing device  
 UNI EN 1717-11/2002

## PLUS S 3P BX clear housings with discharge valve

### HOUSINGS WITH BRASS BSP THREADS

CODE	MODEL	SUITABLE CARTRIDGE	IN/OUT	DIMENSIONS mm		
				A	B	C
RA111T123	SENIOR PLUS S 3P MFO BX TS	10"	1/2"	450	133	130
RA111T428	SENIOR PLUS S 3P AFO BX TS	10"	3/4"	450	133	130
RA111T726	SENIOR PLUS S 3P BFO BX TS	10"	1"	460	145	130
RA115T123	MASTER PLUS S 3P MFO BX TS	20"	1/2"	710	133	130
RA115T428	MASTER PLUS S 3P AFO BX TS	20"	3/4"	710	133	130
RA115T725	MASTER PLUS S 3P BFO BX TS	20"	1"	720	145	130

### HOUSINGS WITH PLASTIC BSP THREADS

CODE	MODEL	SUITABLE CARTRIDGE	IN/OUT	DIMENSIONS mm		
				A	B	C
RA111T127	SENIOR PLUS S 3P MFP BX TS	10"	1/2"	450	133	130
RA111T527	SENIOR PLUS S 3P AFP BX TS	10"	3/4"	450	133	130
RA111T827	SENIOR PLUS S 3P BFP BX TS	10"	1"	460	145	130
RA115T127	MASTER PLUS S 3P MFP BX TS	20"	1/2"	710	133	130
RA115T527	MASTER PLUS S 3P AFP BX TS	20"	3/4"	710	133	130
RA115T727	MASTER PLUS S 3P BFP BX TS	20"	1"	720	145	130

### HOUSINGS WITH PLASTIC NPT THREADS

CODE	MODEL	SUITABLE CARTRIDGE	IN/OUT	DIMENSIONS mm		
				A	B	C
RA111T433	SENIOR PLUS S 3P AFP NPT BX TS	10"	3/4"	450	133	130
RA111T733	SENIOR PLUS S 3P BFP NPT BX TS	10"	1"	460	145	130
RA115T433	MASTER PLUS S 3P AFP NPT BX TS	20"	3/4"	710	133	130
RA115T733	MASTER PLUS S 3P BFP NPT BX TS	20"	1"	720	145	130

### HOUSINGS WITH PLASTIC BSP THREADS

CODE	MODEL	SUITABLE CARTRIDGE	IN/OUT	DIMENSIONS mm		
				A	B	C
RA111T130	SENIOR PLUS S 3P MMP BX TS	10"	1/2"	450	175	130
RA111T430	SENIOR PLUS S 3P AMP BX TS	10"	3/4"	450	175	130
RA111T730	SENIOR PLUS S 3P BMP BX TS	10"	1"	460	175	130
RA115T130	MASTER PLUS S 3P MMP BX TS	20"	1/2"	710	175	130
RA115T430	MASTER PLUS S 3P AMP BX TS	20"	3/4"	710	175	130
RA115T730	MASTER PLUS S 3P BMP BX TS	20"	1"	720	175	130



Some items in the list are subject to minimum order quantities and/or to longer delivery term.



# PLUS S M 3P BX

## WORKING CONDITIONS

Max working pressure:  
 BSP versions \_\_\_\_\_ 8 bar (116 psi)  
 NPT versions \_\_\_\_\_ 8,6 bar (125 psi)  
 Max working temperature \_\_\_\_\_ 45°C (113°F)  
 Min working temperature \_\_\_\_\_ 4°C (39,2°F)

## SPECIFICATIONS

Non-toxic materials, suitable for drinking water.  
 Head and ring nut: reinforced polypropylene.  
 Bowl: PET.  
 O-ring: EPDM.  
 Breather-valve: body polypropylene, o-ring EPDM.  
 IN/OUT threads: CW 617 N brass inserts.  
 Manometers: radial type, pressure range 0-12 bar, 0-170 psi.  
 Discharge ball-valve: CW 617 N brass nickel plated.  
 Discharge plastic nipple: reinforced polypropylene.  
 Drain funnel: reinforced polypropylene.

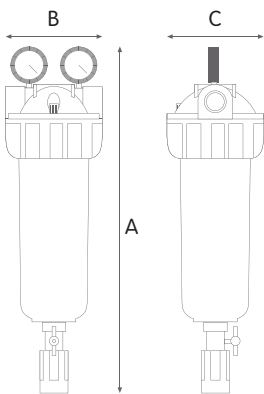

**DRAIN FUNNEL**  
 Back-flow preventing device  
 UNI EN 1717-11/2002

## PLUS S M 3P BX clear housings with discharge valve and 2 manometers

### HOUSINGS WITH BRASS BSP THREADS

CODE	MODEL	SUITABLE CARTRIDGE	IN/OUT	DIMENSIONS mm		
				A	B	C
RA111T134	SENIOR PLUS S M 3P MFO BX TS	10"	1/2"	500	133	130
RA111T434	SENIOR PLUS S M 3P AFO BX TS	10"	3/4"	500	133	130
RA111T734	SENIOR PLUS S M 3P BFO BX TS	10"	1"	510	145	130
RA115T134	MASTER PLUS S M 3P MFO BX TS	20"	1/2"	760	133	130
RA115T434	MASTER PLUS S M 3P AFO BX TS	20"	3/4"	760	133	130
RA115T734	MASTER PLUS S M 3P BFO BX TS	20"	1"	770	145	130



### HOUSINGS WITH PLASTIC BSP THREADS

CODE	MODEL	SUITABLE CARTRIDGE	IN/OUT	DIMENSIONS mm		
				A	B	C
RA111T437	SENIOR PLUS S M 3P AFP BX TS	10"	3/4"	500	133	130
RA111T737	SENIOR PLUS S M 3P BFP BX TS	10"	1"	510	145	130
RA115T437	MASTER PLUS S M 3P AFP BX TS	20"	3/4"	760	133	130
RA115T737	MASTER PLUS S M 3P BFP BX TS	20"	1"	770	145	130



### HOUSINGS WITH PLASTIC NPT THREADS

CODE	MODEL	SUITABLE CARTRIDGE	IN/OUT	DIMENSIONS mm		
				A	B	C
RA111T135	SENIOR PLUS S M 3P AFP NPT BX TS	10"	3/4"	500	133	130
RA111T435	SENIOR PLUS S M 3P BFP NPT BX TS	10"	1"	510	145	130
RA115T435	MASTER PLUS S M 3P AFP NPT BX TS	20"	3/4"	760	133	130
RA115T735	MASTER PLUS S M 3P BFP NPT BX TS	20"	1"	770	145	130

Some items in the list are subject to minimum order quantities and/or to longer delivery term.



# DUPLEX PLUS 3P BX

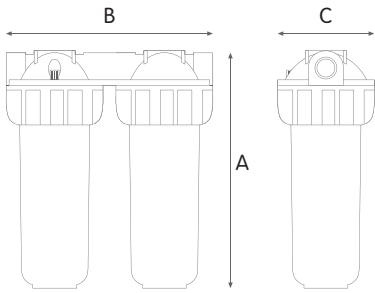

## WORKING CONDITIONS

Max working pressure:  
 BSP versions \_\_\_\_\_ 8 bar (116 psi)  
 NPT versions \_\_\_\_\_ 8,6 bar (125 psi)  
 Max working temperature \_\_\_\_\_ 45°C (113°F)  
 Min working temperature \_\_\_\_\_ 4°C (39,2°F)

## SPECIFICATIONS

Non-toxic materials, suitable for drinking water.  
 Head and ring nut: reinforced polypropylene.  
 Bowl: PET.  
 O-ring: EPDM.  
 Breather-valve: body polypropylene, o-ring EPDM.  
 IN/OUT brass threads: CW 617 N brass.

## DUPLEX PLUS 3P BX clear housings

### HOUSINGS WITH BRASS BSP THREADS

CODE	MODEL	SUITABLE CARTRIDGE	IN/OUT	DIMENSIONS mm		
				A	B	C
RA108T421	MEDIUM DUPLEX PLUS 3P AFO BX TS	5"	3/4"	191	275	130
RA108T721	MEDIUM DUPLEX PLUS 3P BFO BX TS	5"	1"	191	275	130
RA110T421	JUNIOR DUPLEX PLUS 3P AFO BX TS	7"	3/4"	241	275	130
RA110T721	JUNIOR DUPLEX PLUS 3P BFO BX TS	7"	1"	241	275	130
RA112T421	SENIOR DUPLEX PLUS 3P AFO BX TS	10"	3/4"	315	275	130
RA112T721	SENIOR DUPLEX PLUS 3P BFO BX TS	10"	1"	315	275	130
RA116T421	MASTER DUPLEX PLUS 3P AFO BX TS	20"	3/4"	571	275	130
RA116T721	MASTER DUPLEX PLUS 3P BFO BX TS	20"	1"	571	275	130

### HOUSINGS WITH PLASTIC BSP THREADS

CODE	MODEL	SUITABLE CARTRIDGE	IN/OUT	DIMENSIONS mm		
				A	B	C
RA108T521	MEDIUM DUPLEX PLUS 3P AFP BX TS	5"	3/4"	191	275	130
RA110T521	JUNIOR DUPLEX PLUS 3P AFP BX TS	7"	3/4"	241	275	130
RA112T521	SENIOR DUPLEX PLUS 3P AFP BX TS	10"	3/4"	315	275	130
RA116T521	MASTER DUPLEX PLUS 3P AFP BX TS	20"	3/4"	571	275	130

### HOUSINGS WITH PLASTIC NPT THREADS

CODE	MODEL	SUITABLE CARTRIDGE	IN/OUT	DIMENSIONS mm		
				A	B	C
RA108T424	MEDIUM DUPLEX PLUS 3P AFP NPT BX TS	5"	3/4"	191	275	130
RA110T424	JUNIOR DUPLEX PLUS 3P AFP NPT BX TS	7"	3/4"	241	275	130
RA112T621	SENIOR DUPLEX PLUS 3P AFP NPT BX TS	10"	3/4"	315	275	130
RA116T424	MASTER DUPLEX PLUS 3P AFP NPT BX TS	20"	3/4"	571	275	130

Some items in the list are subject to minimum order quantities and/or to longer delivery term.

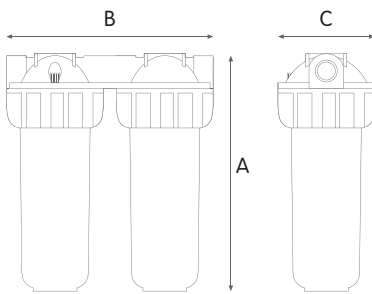

**WORKING CONDITIONS**

Max working pressure:  
 BSP versions \_\_\_\_\_ 8 bar (116 psi)  
 NPT versions \_\_\_\_\_ 8,6 bar (125 psi)  
 Max working temperature \_\_\_\_\_ 45°C (113°F)  
 Min working temperature \_\_\_\_\_ 4°C (39,2°F)

**SPECIFICATIONS**

Non-toxic materials, suitable for drinking water.  
 Head and ring nut: reinforced polypropylene.  
 Bowl: PET.  
 O-ring: EPDM.  
 Breather-valve: body polypropylene, o-ring EPDM.  
 IN/OUT brass threads: CW 617 N brass.

**DUPLEX PLUS 3P BX blue housings**

**HOUSINGS WITH BRASS BSP THREADS**

CODE	MODEL	SUITABLE CARTRIDGE	IN/OUT	DIMENSIONS mm		
				A	B	C
RA108T422	MEDIUM DUPLEX PLUS 3P AFO BX AB	5"	3/4"	191	275	130
RA108T722	MEDIUM DUPLEX PLUS 3P BFO BX AB	5"	1"	191	275	130
RA110T422	JUNIOR DUPLEX PLUS 3P AFO BX AB	7"	3/4"	241	275	130
RA110T722	JUNIOR DUPLEX PLUS 3P BFO BX AB	7"	1"	241	275	130
RA112T422	SENIOR DUPLEX PLUS 3P AFO BX AB	10"	3/4"	315	275	130
RA112T722	SENIOR DUPLEX PLUS 3P BFO BX AB	10"	1"	315	275	130
RA116T422	MASTER DUPLEX PLUS 3P AFO BX AB	20"	3/4"	571	275	130
RA116T722	MASTER DUPLEX PLUS 3P BFO BX AB	20"	1"	571	275	130

**HOUSINGS WITH PLASTIC BSP THREADS**

CODE	MODEL	SUITABLE CARTRIDGE	IN/OUT	DIMENSIONS mm		
				A	B	C
RA108T522	MEDIUM DUPLEX PLUS 3P AFP BX AB	5"	3/4"	191	275	130
RA110T522	JUNIOR DUPLEX PLUS 3P AFP BX AB	7"	3/4"	241	275	130
RA112T522	SENIOR DUPLEX PLUS 3P AFP BX AB	10"	3/4"	315	275	130
RA116T522	MASTER DUPLEX PLUS 3P AFP BX AB	20"	3/4"	571	275	130

**HOUSINGS WITH PLASTIC NPT THREADS**

CODE	MODEL	SUITABLE CARTRIDGE	IN/OUT	DIMENSIONS mm		
				A	B	C
RA108T426	MEDIUM DUPLEX PLUS 3P AFP NPT BX AB	5"	3/4"	191	275	130
RA110T426	JUNIOR DUPLEX PLUS 3P AFP NPT BX AB	7"	3/4"	241	275	130
RA112T622	SENIOR DUPLEX PLUS 3P AFP NPT BX AB	10"	3/4"	315	275	130
RA116T622	MASTER DUPLEX PLUS 3P AFP NPT BX AB	20"	3/4"	571	275	130

Some items in the list are subject to minimum order quantities and/or to longer delivery term.





# TRIPLEX PLUS 3P BX

## WORKING CONDITIONS

Max working pressure:  
 BSP versions \_\_\_\_\_ 8 bar (116 psi)  
 NPT versions \_\_\_\_\_ 8,6 bar (125 psi)  
 Max working temperature \_\_\_\_\_ 45°C (113°F)  
 Min working temperature \_\_\_\_\_ 4°C (39,2°F)

## SPECIFICATIONS

Non-toxic materials, suitable for drinking water.  
 Head and ring nut: reinforced polypropylene.  
 Bowl: PET.  
 O-ring: EPDM.  
 Breather-valve: body polypropylene, o-ring EPDM.  
 IN/OUT brass threads: CW 617 N brass.

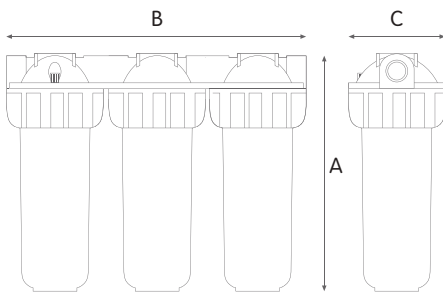

## TRIPLEX PLUS 3P BX clear housings

### HOUSINGS WITH BRASS BSP THREADS



CODE	MODEL	SUITABLE CARTRIDGE	IN/OUT	DIMENSIONS mm		
				A	B	C
RA108T441	MEDIUM TRIPLEX PLUS 3P AFO BX TS	5"	3/4"	191	420	130
RA108T741	MEDIUM TRIPLEX PLUS 3P BFO BX TS	5"	1"	191	420	130
RA110T441	JUNIOR TRIPLEX PLUS 3P AFO BX TS	7"	3/4"	241	420	130
RA110T741	JUNIOR TRIPLEX PLUS 3P BFO BX TS	7"	1"	241	420	130
RA112T441	SENIOR TRIPLEX PLUS 3P AFO BX TS	10"	3/4"	315	420	130
RA112T741	SENIOR TRIPLEX PLUS 3P BFO BX TS	10"	1"	315	420	130
RA116T441	MASTER TRIPLEX PLUS 3P AFO BX TS	20"	3/4"	571	420	130
RA116T741	MASTER TRIPLEX PLUS 3P BFO BX TS	20"	1"	571	420	130

### HOUSINGS WITH PLASTIC BSP THREADS



CODE	MODEL	SUITABLE CARTRIDGE	IN/OUT	DIMENSIONS mm		
				A	B	C
RA108T541	MEDIUM TRIPLEX PLUS 3P AFP BX TS	5"	3/4"	191	420	130
RA108T841	MEDIUM TRIPLEX PLUS 3P BFP BX TS	5"	1"	191	420	130
RA110T541	JUNIOR TRIPLEX PLUS 3P AFP BX TS	7"	3/4"	241	420	130
RA110T841	JUNIOR TRIPLEX PLUS 3P BFP BX TS	7"	1"	241	420	130
RA112T541	SENIOR TRIPLEX PLUS 3P AFP BX TS	10"	3/4"	315	420	130
RA112T841	SENIOR TRIPLEX PLUS 3P BFP BX TS	10"	1"	315	420	130
RA116T541	MASTER TRIPLEX PLUS 3P AFP BX TS	20"	3/4"	571	420	130
RA116T841	MASTER TRIPLEX PLUS 3P BFP BX TS	20"	1"	571	420	130

### HOUSINGS WITH PLASTIC NPT THREADS

CODE	MODEL	SUITABLE CARTRIDGE	IN/OUT	DIMENSIONS mm		
				A	B	C
RA108T444	MEDIUM TRIPLEX PLUS 3P AFP NPT BX TS	5"	3/4"	191	420	130
RA110T444	JUNIOR TRIPLEX PLUS 3P AFP NPT BX TS	7"	3/4"	241	420	130
RA112T444	SENIOR TRIPLEX PLUS 3P AFP NPT BX TS	10"	3/4"	315	420	130
RA116T444	MASTER TRIPLEX PLUS 3P AFP NPT BX TS	20"	3/4"	571	420	130

Some items in the list are subject to minimum order quantities and/or to longer delivery term.

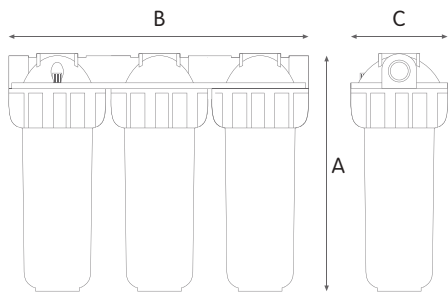

**WORKING CONDITIONS**

Max working pressure:  
 BSP versions \_\_\_\_\_ 8 bar (116 psi)  
 NPT versions \_\_\_\_\_ 8,6 bar (125 psi)  
 Max working temperature \_\_\_\_\_ 45°C (113°F)  
 Min working temperature \_\_\_\_\_ 4°C (39,2°F)

**SPECIFICATIONS**

Non-toxic materials, suitable for drinking water.  
 Head and ring nut: reinforced polypropylene.  
 Bowl: PET.  
 O-ring: EPDM.  
 Breather-valve: body polypropylene, o-ring EPDM.  
 IN/OUT brass threads: CW 617 N brass.

**TRIPLEX PLUS 3P BX blue housings**

**HOUSINGS WITH BRASS BSP THREADS**

CODE	MODEL	SUITABLE CARTRIDGE	IN/OUT	DIMENSIONS mm		
				A	B	C
RA108T442	MEDIUM TRIPLEX PLUS 3P AFO BX AB	5"	3/4"	191	420	130
RA108T742	MEDIUM TRIPLEX PLUS 3P BFO BX AB	5"	1"	191	420	130
RA110T442	JUNIOR TRIPLEX PLUS 3P AFO BX AB	7"	3/4"	241	420	130
RA110T742	JUNIOR TRIPLEX PLUS 3P BFO BX AB	7"	1"	241	420	130
RA112T442	SENIOR TRIPLEX PLUS 3P AFO BX AB	10"	3/4"	315	420	130
RA112T742	SENIOR TRIPLEX PLUS 3P BFO BX AB	10"	1"	315	420	130
RA116T442	MASTER TRIPLEX PLUS 3P AFO BX AB	20"	3/4"	571	420	130
RA116T742	MASTER TRIPLEX PLUS 3P BFO BX AB	20"	1"	571	420	130

**HOUSINGS WITH PLASTIC BSP THREADS**

CODE	MODEL	SUITABLE CARTRIDGE	IN/OUT	DIMENSIONS mm		
				A	B	C
RA108T542	MEDIUM TRIPLEX PLUS 3P AFP BX AB	5"	3/4"	191	420	130
RA108T842	MEDIUM TRIPLEX PLUS 3P BFP BX AB	5"	1"	191	420	130
RA110T542	JUNIOR TRIPLEX PLUS 3P AFP BX AB	7"	3/4"	241	420	130
RA110T842	JUNIOR TRIPLEX PLUS 3P BFP BX AB	7"	1"	241	420	130
RA112T542	SENIOR TRIPLEX PLUS 3P AFP BX AB	10"	3/4"	315	420	130
RA112T842	SENIOR TRIPLEX PLUS 3P BFP BX AB	10"	1"	315	420	130
RA116T542	MASTER TRIPLEX PLUS 3P AFP BX AB	20"	3/4"	571	420	130
RA116T842	MASTER TRIPLEX PLUS 3P BFP BX AB	20"	1"	571	420	130

**HOUSINGS WITH PLASTIC NPT THREADS**

CODE	MODEL	SUITABLE CARTRIDGE	IN/OUT	DIMENSIONS mm		
				A	B	C
RA108T446	MEDIUM TRIPLEX PLUS 3P AFP NPT BX AB	5"	3/4"	191	420	130
RA110T446	JUNIOR TRIPLEX PLUS 3P AFP NPT BX AB	7"	3/4"	241	420	130
RA112T446	SENIOR TRIPLEX PLUS 3P AFP NPT BX AB	10"	3/4"	315	420	130
RA116T446	MASTER TRIPLEX PLUS 3P AFP NPT BX AB	20"	3/4"	571	420	130

Some items in the list are subject to minimum order quantities and/or to longer delivery term.



# PLUS 3P CX

## WORKING CONDITIONS

Max working pressure \_\_\_\_\_ 8 bar (116 psi)  
 Max working temperature \_\_\_\_\_ 45°C (113°F)  
 Min working temperature \_\_\_\_\_ 4°C (39,2°F)

## SPECIFICATIONS

Non-toxic materials, suitable for drinking water.  
 Head and ring nut: reinforced polypropylene.  
 Bowl: PET.  
 O-ring: EPDM.  
 Breather-valve: body polypropylene, o-ring EPDM.  
 IN/OUT brass threads: CW 617 N brass.

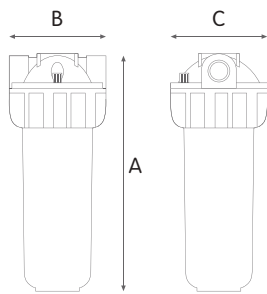

## PLUS 3P CX clear housings

### HOUSINGS WITH BRASS BSP THREADS

CODE	MODEL	SUITABLE CARTRIDGE	IN/OUT	DIMENSIONS mm		
				A	B	C
RA111T831	SENIOR PLUS 3P DFO CX TS	10"	1"1/4	341	143	130
RA111T841	SENIOR PLUS 3P EFO CX TS	10"	1"1/2	341	143	130
* RA111T851	SENIOR PLUS 3P FFO CX TS	10"	2"	341	143	130
RA115T831	MASTER PLUS 3P DFO CX TS	20"	1"1/4	600	143	130
RA115T841	MASTER PLUS 3P EFO CX TS	20"	1"1/2	600	143	130
* RA115T851	MASTER PLUS 3P FFO CX TS	20"	2"	600	143	130

\* Max working pressure \_\_\_\_\_ 6 bar (87 psi)

### HOUSINGS WITH PLASTIC BSP THREADS

CODE	MODEL	SUITABLE CARTRIDGE	IN/OUT	DIMENSIONS mm		
				A	B	C
RA111T833	SENIOR PLUS 3P DFP CX TS	10"	1"1/4	341	143	130
RA111T843	SENIOR PLUS 3P EFP CX TS	10"	1"1/2	341	143	130
RA111T853	SENIOR PLUS 3P FFP CX TS	10"	2"	341	143	130
RA115T833	MASTER PLUS 3P DFP CX TS	20"	1"1/4	600	143	130
RA115T843	MASTER PLUS 3P EFP CX TS	20"	1"1/2	600	143	130
RA115T853	MASTER PLUS 3P FFP CX TS	20"	2"	600	143	130

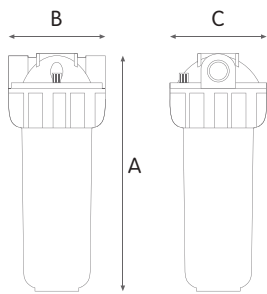

**WORKING CONDITIONS**

Max working pressure \_\_\_\_\_ 8 bar (116 psi)  
 Max working temperature \_\_\_\_\_ 45°C (113°F)  
 Min working temperature \_\_\_\_\_ 4°C (39,2°F)

**SPECIFICATIONS**

Non-toxic materials, suitable for drinking water.  
 Head and ring nut: reinforced polypropylene.  
 Bowl: PET.  
 O-ring: EPDM.  
 Breather-valve: body polypropylene, o-ring EPDM.  
 IN/OUT brass threads: CW 617 N brass.

**PLUS 3P CX blue housings**

**HOUSINGS WITH BRASS BSP THREADS**

CODE	MODEL	SUITABLE CARTRIDGE	IN/OUT	DIMENSIONS mm		
				A	B	C
RA111T832	SENIOR PLUS 3P DFO CX AB	10"	1"1/4	341	143	130
RA111T842	SENIOR PLUS 3P EFO CX AB	10"	1"1/2	341	143	130
* RA111T852	SENIOR PLUS 3P FFO CX AB	10"	2"	341	143	130
RA115T832	MASTER PLUS 3P DFO CX AB	20"	1"1/4	600	143	130
RA115T842	MASTER PLUS 3P EFO CX AB	20"	1"1/2	600	143	130
* RA115T852	MASTER PLUS 3P FFO CX AB	20"	2"	600	143	130

\* Max working pressure \_\_\_\_\_ 6 bar (87 psi)

**HOUSINGS WITH PLASTIC BSP THREADS**

CODE	MODEL	SUITABLE CARTRIDGE	IN/OUT	DIMENSIONS mm		
				A	B	C
RA111T834	SENIOR PLUS 3P DFP CX AB	10"	1"1/4	341	143	130
RA111T844	SENIOR PLUS 3P EFP CX AB	10"	1"1/2	341	143	130
RA111T854	SENIOR PLUS 3P FFP CX AB	10"	2"	341	143	130
RA115T834	MASTER PLUS 3P DFP CX AB	20"	1"1/4	600	143	130
RA115T844	MASTER PLUS 3P EFP CX AB	20"	1"1/2	600	143	130
RA115T854	MASTER PLUS 3P FFP CX AB	20"	2"	600	143	130



# PLUS S 3P CX

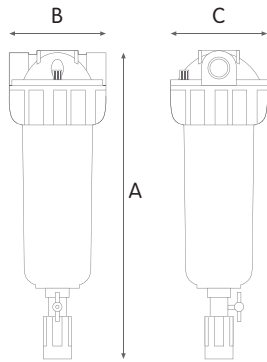

## WORKING CONDITIONS

Max working pressure \_\_\_\_\_ 8 bar (116 psi)  
 Max working temperature \_\_\_\_\_ 45°C (113°F)  
 Min working temperature \_\_\_\_\_ 4°C (39,2°F)

## SPECIFICATIONS

Non-toxic materials, suitable for drinking water.  
 Head and ring nut: reinforced polypropylene.  
 Bowl: PET.  
 O-ring: EPDM.  
 Breather-valve: body polypropylene, o-ring EPDM.  
 IN/OUT threads: CW 617 N brass inserts.  
 Discharge ball-valve: CW 617 N brass nickel plated.  
 Discharge plastic nipple: reinforced polypropylene.  
 Drain funnel: reinforced polypropylene.



**DRAIN FUNNEL**  
 Back-flow preventing device  
 UNI EN 1717-11/2002

## PLUS S 3P CX clear housings with discharge valve

### HOUSINGS WITH BRASS BSP THREADS

CODE	MODEL	SUITABLE CARTRIDGE	IN/OUT	DIMENSIONS mm		
				A	B	C
RA111T835	SENIOR PLUS S 3P DFO CX TS	10"	1"1/4	356	143	130
RA111T845	SENIOR PLUS S 3P EFO CX TS	10"	1"1/2	356	143	130
* RA111T855	SENIOR PLUS S 3P FFO CX TS	10"	2"	356	143	130
RA115T835	MASTER PLUS S 3P DFO CX TS	20"	1"1/4	615	143	130
RA115T845	MASTER PLUS S 3P EFO CX TS	20"	1"1/2	615	143	130
* RA115T855	MASTER PLUS S 3P FFO CX TS	20"	2"	615	143	130

\* Max working pressure \_\_\_\_\_ 6 bar (87 psi)



### HOUSINGS WITH PLASTIC BSP THREADS

CODE	MODEL	SUITABLE CARTRIDGE	IN/OUT	DIMENSIONS mm		
				A	B	C
RA111T836	SENIOR PLUS S 3P DFP CX TS	10"	1"1/4	356	143	130
RA111T846	SENIOR PLUS S 3P EFP CX TS	10"	1"1/2	356	143	130
RA111T856	SENIOR PLUS S 3P FFP CX TS	10"	2"	356	143	130
RA115T836	MASTER PLUS S 3P DFP CX TS	20"	1"1/4	615	143	130
RA115T846	MASTER PLUS S 3P EFP CX TS	20"	1"1/2	615	143	130
RA115T856	MASTER PLUS S 3P FFP CX TS	20"	2"	615	143	130



SAN!C

WATER FILTERS WITH  
ANTIMICROBIAL  
TECHNOLOGY

## PLUS 3P SAN!C

filter housings  
with antimicrobial technology  
for cartridges SX and BX

Range of housings with antimicrobial product protection  
provided by a silver based antimicrobial agent included in the plastic matrix  
with a specific injection molding technology

Powered by Microban® antimicrobial technology   
**MICROBAN**®

Microban® technology is not designed to purify drinking water, but to fight the growth of stain and odor causing bacteria on the housing and filter itself which could adversely affect filter life and performance.  
MICROBAN is a registered trademark of Microban Products Company.



# HOUSINGS PLUS 3P SANIC

## FOR SANIC CARTRIDGES SX AND BX

PLUS 3P SANIC housings are designed to work in combination with SANIC filter cartridges provided with the same antimicrobial technology and to keep the filter cleaner for longer in every single pore of their structure.

### Housings PLUS 3P SX SANIC fit to SANIC SX (DOE) cartridges.

The full range of Atlas Filtri® SANIC SX cartridges is suitable to PLUS 3P SX SANIC housings and provide the widest range of water filtration units with ANTIMICROBIAL TECHNOLOGY.

### Housings PLUS 3P BX SANIC fit to exclusive SANIC BX cartridges with 45 mm double o-ring collar.

The full range of Atlas Filtri® SANIC BX cartridges is suitable to PLUS 3P BX SANIC housings and provide the widest range of water filtration units with ANTIMICROBIAL TECHNOLOGY.



## SX SANIC

cartridges with standard flat seals.



## BX SANIC

cartridges with 45 mm double o-ring collar.  
Quick-fit connection for a perfect tightening.

All 3P PLUS SANIC housings are available as single, DUPLEX and TRIPLEX models. PLUS 3P SX SANIC and PLUS 3P BX SANIC housings are suitable for every Point-of-Entry (POE) application, as single or multi-stage on-line filters. Thanks to the antimicrobial protection SANIC housings with SANIC filter cartridges are the most reliable sediment filtration systems for all drinking water application by keeping the filter cleaner for longer.

## CERTIFICATIONS



Systems tested and certified by IAPMO RT against NSF/ANSI 42 for bacteriostasis effect. Components tested and certified by IAPMO RT against NSF/ANSI Standards 42 and 61 for material and structural integrity requirements only. In compliance with Drinking Water Treatment Units regulations, USA and Canada.



Housings are tested and certified under the most stringent procedures worldwide, in compliance with DM 25 (Italy), with the sanitary certification ACS (France), EAC/Ghostreghistracia (Russia) and WaterMark (Australia).

## SYMBOLS LEGEND



For domestic use



For technical and industrial use



Filter housings made in PET, a highly recyclable plastic, are manufactured with a proprietary procedure saving up to 60% of energy in injection molding compared with standard plastics. That is one of Atlas Filtri commitments for the reduction of green house gas (CO<sub>2</sub>) emissions in the atmosphere.

## ACCESSORIES INCLUDED



-N- spanner (for Senior and Master models)



-U- spanner (for Medium and Junior models)



-S- wall bracket



-D- wall bracket

## ACCESSORIES ON DEMAND



-T- wall bracket CODE RB7401010



3/4" brass nipples with o-ring (pair) CODE RB7404001

1" brass nipples with o-ring (pair) CODE RB7404002



3/4" plastic nipple with o-ring CODE LB7404012



3/4"-1/4" plastic reduction with o-ring CODE LB9020611



-LUBRIKIT- single-dose lubricant for housing o-ring  
CODE RE9020650

HOUSINGS RANGE



SENIOR PLUS 3P A FO SX SANIC TS

HOUSINGS MODEL VERSION IN / OUT THREADS TYPE CARTRIDGE TYPE BOWL TYPE

- MEDIUM DUPLEX
- JUNIOR DUPLEX
- SENIOR DUPLEX
- MASTER DUPLEX



- MEDIUM TRIPLEX
- JUNIOR TRIPLEX
- SENIOR TRIPLEX
- MASTER TRIPLEX



- M 1/2"
- A 3/4"
- B 1"

FO - BRASS BSP \*

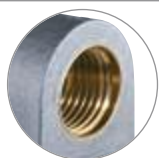

FP - PLASTIC BSP \*

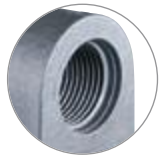

FP-NPT - PLASTIC NPT \*\*

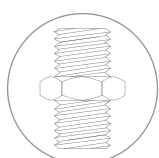

\* BSP parallel (cylindrical) ISO 228

SX - STANDARD FLAT SEALS



BX - QUICK-FIT DOUBLE O-RING 45 mm



SANIC TS - CLEAR BOWL WITH ANTI-MICROBIAL AGENT

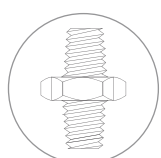

\*\* NPT tapered (conical) ANSI/ASME B1.20.1



# PLUS 3P SX SANIC

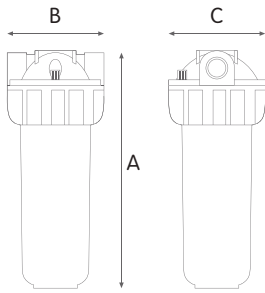

## WORKING CONDITIONS

Max working pressure:  
 BSP versions \_\_\_\_\_ 8 bar (116 psi)  
 NPT versions \_\_\_\_\_ 8,6 bar (125 psi)  
 Max working temperature \_\_\_\_\_ 45°C (113°F)  
 Min working temperature \_\_\_\_\_ 4°C (39,2°F)

## SPECIFICATIONS

Non-toxic materials, suitable for drinking water.  
 Head and ring nut: reinforced polypropylene.  
 Bowl: PET with antimicrobial technology.  
 O-ring: EPDM.  
 Breather-valve: body polypropylene, o-ring EPDM.  
 IN/OUT brass threads: CW 617 N brass.

## PLUS 3P SX SANIC

### HOUSINGS WITH BRASS BSP THREADS

CODE	MODEL	SUITABLE CARTRIDGE	IN/OUT	DIMENSIONS mm		
				A	B	C
SA107T111	MEDIUM PLUS 3P MFO SX SANIC TS	5"	1/2"	191	133	130
SA107T411	MEDIUM PLUS 3P AFO SX SANIC TS	5"	3/4"	191	133	130
SA107T711	MEDIUM PLUS 3P BFO SX SANIC TS	5"	1"	197	145	130
SA109T111	JUNIOR PLUS 3P MFO SX SANIC TS	7"	1/2"	241	133	130
SA109T411	JUNIOR PLUS 3P AFO SX SANIC TS	7"	3/4"	241	133	130
SA109T711	JUNIOR PLUS 3P BFO SX SANIC TS	7"	1"	247	145	130
SA111T111	SENIOR PLUS 3P MFO SX SANIC TS	10"	1/2"	315	133	130
SA111T411	SENIOR PLUS 3P AFO SX SANIC TS	10"	3/4"	315	133	130
SA111T711	SENIOR PLUS 3P BFO SX SANIC TS	10"	1"	321	145	130
SA115T111	MASTER PLUS 3P MFO SX SANIC TS	20"	1/2"	571	133	130
SA115T411	MASTER PLUS 3P AFO SX SANIC TS	20"	3/4"	571	133	130
SA115T711	MASTER PLUS 3P BFO SX SANIC TS	20"	1"	577	145	130

### HOUSINGS WITH PLASTIC BSP THREADS

CODE	MODEL	SUITABLE CARTRIDGE	IN/OUT	DIMENSIONS mm		
				A	B	C
SA107T211	MEDIUM PLUS 3P MFP SX SANIC TS	5"	1/2"	191	133	130
SA107T511	MEDIUM PLUS 3P AFP SX SANIC TS	5"	3/4"	191	133	130
SA107T811	MEDIUM PLUS 3P BFP SX SANIC TS	5"	1"	197	145	130
SA109T211	JUNIOR PLUS 3P MFP SX SANIC TS	7"	1/2"	241	133	130
SA109T511	JUNIOR PLUS 3P AFP SX SANIC TS	7"	3/4"	241	133	130
SA109T811	JUNIOR PLUS 3P BFP SX SANIC TS	7"	1"	247	145	130
SA111T211	SENIOR PLUS 3P MFP SX SANIC TS	10"	1/2"	315	133	130
SA111T511	SENIOR PLUS 3P AFP SX SANIC TS	10"	3/4"	315	133	130
SA111T811	SENIOR PLUS 3P BFP SX SANIC TS	10"	1"	321	145	130
SA115T211	MASTER PLUS 3P MFP SX SANIC TS	20"	1/2"	571	133	130
SA115T511	MASTER PLUS 3P AFP SX SANIC TS	20"	3/4"	571	133	130
SA115T811	MASTER PLUS 3P BFP SX SANIC TS	20"	1"	577	145	130

### HOUSINGS WITH PLASTIC NPT THREADS

CODE	MODEL	SUITABLE CARTRIDGE	IN/OUT	DIMENSIONS mm		
				A	B	C
SA107T513	MEDIUM PLUS 3P AFP NPT SX SANIC TS	5"	3/4"	191	133	130
SA107T813	MEDIUM PLUS 3P BFP NPT SX SANIC TS	5"	1"	197	145	130
SA109T513	JUNIOR PLUS 3P AFP NPT SX SANIC TS	7"	3/4"	241	133	130
SA109T813	JUNIOR PLUS 3P BFP NPT SX SANIC TS	7"	1"	247	145	130
SA111T521	SENIOR PLUS 3P AFP NPT SX SANIC TS	10"	3/4"	315	133	130
SA111T621	SENIOR PLUS 3P BFP NPT SX SANIC TS	10"	1"	321	145	130
SA115T513	MASTER PLUS 3P AFP NPT SX SANIC TS	20"	3/4"	571	133	130
SA115T813	MASTER PLUS 3P BFP NPT SX SANIC TS	20"	1"	577	145	130

## VARIANTS AVAILABLE ON MINIMUM QUANTITY:

- RT housings suitable for filter cartridges with length 508 mm

Some items in the list are subject to minimum order quantities and/or to longer delivery term.



# DUPLEX PLUS 3P SX SANIC

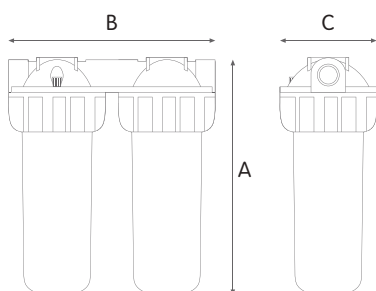

### WORKING CONDITIONS

Max working pressure:  
 BSP versions \_\_\_\_\_ 8 bar (116 psi)  
 NPT versions \_\_\_\_\_ 8,6 bar (125 psi)  
 Max working temperature \_\_\_\_\_ 45°C (113°F)  
 Min working temperature \_\_\_\_\_ 4°C (39,2°F)

### SPECIFICATIONS

Non-toxic materials, suitable for drinking water.  
 Head and ring nut: reinforced polypropylene.  
 Bowl: PET with antimicrobial technology.  
 O-ring: EPDM.  
 Breather-valve: body polypropylene, o-ring EPDM.  
 IN/OUT brass threads: CW 617 N brass.

## DUPLEX PLUS 3P SX SANIC

### HOUSINGS WITH BRASS BSP THREADS

CODE	MODEL	SUITABLE CARTRIDGE	IN/OUT	DIMENSIONS mm		
				A	B	C
SA108T411	MEDIUM DUPLEX PLUS 3P AFO SX SANIC TS	5"	3/4"	191	275	130
SA108T711	MEDIUM DUPLEX PLUS 3P BFO SX SANIC TS	5"	1"	191	275	130
SA110T411	JUNIOR DUPLEX PLUS 3P AFO SX SANIC TS	7"	3/4"	241	275	130
SA110T711	JUNIOR DUPLEX PLUS 3P BFO SX SANIC TS	7"	1"	241	275	130
SA112T411	SENIOR DUPLEX PLUS 3P AFO SX SANIC TS	10"	3/4"	315	275	130
SA112T711	SENIOR DUPLEX PLUS 3P BFO SX SANIC TS	10"	1"	315	275	130
SA116T411	MASTER DUPLEX PLUS 3P AFO SX SANIC TS	20"	3/4"	571	275	130
SA116T711	MASTER DUPLEX PLUS 3P BFO SX SANIC TS	20"	1"	571	275	130

### HOUSINGS WITH PLASTIC BSP THREADS

CODE	MODEL	SUITABLE CARTRIDGE	IN/OUT	DIMENSIONS mm		
				A	B	C
SA108T511	MEDIUM DUPLEX PLUS 3P AFP SX SANIC TS	5"	3/4"	191	275	130
SA110T511	JUNIOR DUPLEX PLUS 3P AFP SX SANIC TS	7"	3/4"	241	275	130
SA112T511	SENIOR DUPLEX PLUS 3P AFP SX SANIC TS	10"	3/4"	315	275	130
SA116T511	MASTER DUPLEX PLUS 3P AFP SX SANIC TS	20"	3/4"	571	275	130

### HOUSINGS WITH PLASTIC NPT THREADS

CODE	MODEL	SUITABLE CARTRIDGE	IN/OUT	DIMENSIONS mm		
				A	B	C
SA108T513	MEDIUM DUPLEX PLUS 3P AFP NPT SX SANIC TS	5"	3/4"	191	275	130
SA110T513	JUNIOR DUPLEX PLUS 3P AFP NPT SX SANIC TS	7"	3/4"	241	275	130
SA112T611	SENIOR DUPLEX PLUS 3P AFP NPT SX SANIC TS	10"	3/4"	315	275	130
SA116T513	MASTER DUPLEX PLUS 3P AFP NPT SX SANIC TS	20"	3/4"	571	275	130

### VARIANTS AVAILABLE ON MINIMUM QUANTITY:

- RT housings suitable for filter cartridges with length 508 mm

Some items in the list are subject to minimum order quantities and/or to longer delivery term.



# TRIPLEX PLUS 3P SX SANIC

## WORKING CONDITIONS

Max working pressure:  
 BSP versions \_\_\_\_\_ 8 bar (116 psi)  
 NPT versions \_\_\_\_\_ 8,6 bar (125 psi)  
 Max working temperature \_\_\_\_\_ 45°C (113°F)  
 Min working temperature \_\_\_\_\_ 4°C (39,2°F)

## SPECIFICATIONS

Non-toxic materials, suitable for drinking water.  
 Head and ring nut: reinforced polypropylene.  
 Bowl: PET with antimicrobial technology.  
 O-ring: EPDM.  
 Breather-valve: body polypropylene, o-ring EPDM.  
 IN/OUT brass threads: CW 617 N brass.

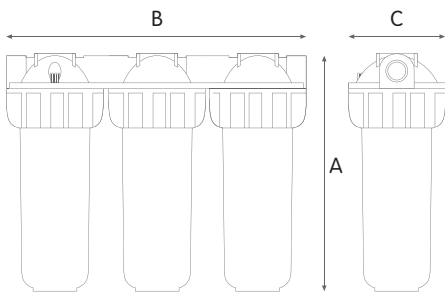

## TRIPLEX PLUS 3P SX SANIC

### HOUSINGS WITH BRASS BSP THREADS

CODE	MODEL	SUITABLE CARTRIDGE	IN/OUT	DIMENSIONS mm		
				A	B	C
SA108T431	MEDIUM TRIPLEX PLUS 3P AFO SX SANIC TS	5"	3/4"	191	420	130
SA108T731	MEDIUM TRIPLEX PLUS 3P BFO SX SANIC TS	5"	1"	191	420	130
SA110T431	JUNIOR TRIPLEX PLUS 3P AFO SX SANIC TS	7"	3/4"	241	420	130
SA110T731	JUNIOR TRIPLEX PLUS 3P BFO SX SANIC TS	7"	1"	241	420	130
SA112T431	SENIOR TRIPLEX PLUS 3P AFO SX SANIC TS	10"	3/4"	315	420	130
SA112T731	SENIOR TRIPLEX PLUS 3P BFO SX SANIC TS	10"	1"	315	420	130
SA116T431	MASTER TRIPLEX PLUS 3P AFO SX SANIC TS	20"	3/4"	571	420	130
SA116T731	MASTER TRIPLEX PLUS 3P BFO SX SANIC TS	20"	1"	571	420	130

### HOUSINGS WITH PLASTIC BSP THREADS

CODE	MODEL	SUITABLE CARTRIDGE	IN/OUT	DIMENSIONS mm		
				A	B	C
SA108T531	MEDIUM TRIPLEX PLUS 3P AFP SX SANIC TS	5"	3/4"	191	420	130
SA108T831	MEDIUM TRIPLEX PLUS 3P BFP SX SANIC TS	5"	1"	191	420	130
SA110T531	JUNIOR TRIPLEX PLUS 3P AFP SX SANIC TS	7"	3/4"	241	420	130
SA110T831	JUNIOR TRIPLEX PLUS 3P BFP SX SANIC TS	7"	1"	241	420	130
SA112T531	SENIOR TRIPLEX PLUS 3P AFP SX SANIC TS	10"	3/4"	315	420	130
SA112T831	SENIOR TRIPLEX PLUS 3P BFP SX SANIC TS	10"	1"	315	420	130
SA116T531	MASTER TRIPLEX PLUS 3P AFP SX SANIC TS	20"	3/4"	571	420	130
SA116T831	MASTER TRIPLEX PLUS 3P BFP SX SANIC TS	20"	1"	571	420	130

### HOUSINGS WITH PLASTIC NPT THREADS

CODE	MODEL	SUITABLE CARTRIDGE	IN/OUT	DIMENSIONS mm		
				A	B	C
SA108T533	MEDIUM TRIPLEX PLUS 3P AFP NPT SX SANIC TS	5"	3/4"	191	420	130
SA110T533	JUNIOR TRIPLEX PLUS 3P AFP NPT SX SANIC TS	7"	3/4"	241	420	130
SA112T533	SENIOR TRIPLEX PLUS 3P AFP NPT SX SANIC TS	10"	3/4"	315	420	130
SA116T533	MASTER TRIPLEX PLUS 3P AFP NPT SX SANIC TS	20"	3/4"	571	420	130

### VARIANTS AVAILABLE ON MINIMUM QUANTITY:

- RT housings suitable for filter cartridges with length 508 mm

Some items in the list are subject to minimum order quantities and/or to longer delivery term.



# PLUS 3P BX SANIC

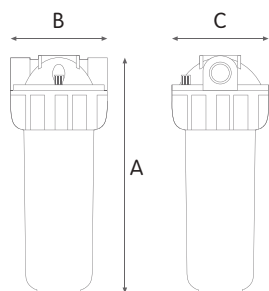

### WORKING CONDITIONS

Max working pressure:  
 BSP versions \_\_\_\_\_ 8 bar (116 psi)  
 NPT versions \_\_\_\_\_ 8,6 bar (125 psi)  
 Max working temperature \_\_\_\_\_ 45°C (113°F)  
 Min working temperature \_\_\_\_\_ 4°C (39,2°F)

### SPECIFICATIONS

Non-toxic materials, suitable for drinking water.  
 Head and ring nut: reinforced polypropylene.  
 Bowl: PET with antimicrobial technology.  
 O-ring: EPDM.  
 Breather-valve: body polypropylene, o-ring EPDM.  
 IN/OUT brass threads: CW 617 N brass.

## PLUS 3P BX SANIC

### HOUSINGS WITH BRASS BSP THREADS

CODE	MODEL	SUITABLE CARTRIDGE	IN/OUT	DIMENSIONS mm		
				A	B	C
SA107T121	MEDIUM PLUS 3P MFO BX SANIC TS	5"	1/2"	191	133	130
SA107T421	MEDIUM PLUS 3P AFO BX SANIC TS	5"	3/4"	191	133	130
SA107T721	MEDIUM PLUS 3P BFO BX SANIC TS	5"	1"	197	145	130
SA109T121	JUNIOR PLUS 3P MFO BX SANIC TS	7"	1/2"	241	133	130
SA109T421	JUNIOR PLUS 3P AFO BX SANIC TS	7"	3/4"	241	133	130
SA109T721	JUNIOR PLUS 3P BFO BX SANIC TS	7"	1"	247	145	130
SA111T121	SENIOR PLUS 3P MFO BX SANIC TS	10"	1/2"	315	133	130
SA111T421	SENIOR PLUS 3P AFO BX SANIC TS	10"	3/4"	315	133	130
SA111T721	SENIOR PLUS 3P BFO BX SANIC TS	10"	1"	321	145	130
SA115T121	MASTER PLUS 3P MFO BX SANIC TS	20"	1/2"	571	133	130
SA115T421	MASTER PLUS 3P AFO BX SANIC TS	20"	3/4"	571	133	130
SA115T721	MASTER PLUS 3P BFO BX SANIC TS	20"	1"	577	145	130

### HOUSINGS WITH PLASTIC BSP THREADS

CODE	MODEL	SUITABLE CARTRIDGE	IN/OUT	DIMENSIONS mm		
				A	B	C
SA107T221	MEDIUM PLUS 3P MFP BX SANIC TS	5"	1/2"	191	133	130
SA107T521	MEDIUM PLUS 3P AFP BX SANIC TS	5"	3/4"	191	133	130
SA107T821	MEDIUM PLUS 3P BFP BX SANIC TS	5"	1"	197	145	130
SA109T221	JUNIOR PLUS 3P MFP BX SANIC TS	7"	1/2"	241	133	130
SA109T521	JUNIOR PLUS 3P AFP BX SANIC TS	7"	3/4"	241	133	130
SA109T821	JUNIOR PLUS 3P BFP BX SANIC TS	7"	1"	247	145	130
SA111T221	SENIOR PLUS 3P MFP BX SANIC TS	10"	1/2"	315	133	130
SA111T522	SENIOR PLUS 3P AFP BX SANIC TS	10"	3/4"	315	133	130
SA111T821	SENIOR PLUS 3P BFP BX SANIC TS	10"	1"	321	145	130
SA115T221	MASTER PLUS 3P MFP BX SANIC TS	20"	1/2"	571	133	130
SA115T521	MASTER PLUS 3P AFP BX SANIC TS	20"	3/4"	571	133	130
SA115T821	MASTER PLUS 3P BFP BX SANIC TS	20"	1"	577	145	130

### HOUSINGS WITH PLASTIC NPT THREADS

CODE	MODEL	SUITABLE CARTRIDGE	IN/OUT	DIMENSIONS mm		
				A	B	C
SA107T523	MEDIUM PLUS 3P AFP NPT BX SANIC TS	5"	3/4"	191	133	130
SA107T823	MEDIUM PLUS 3P BFP NPT BX SANIC TS	5"	1"	197	145	130
SA109T523	JUNIOR PLUS 3P AFP NPT BX SANIC TS	7"	3/4"	241	133	130
SA109T823	JUNIOR PLUS 3P BFP NPT BX SANIC TS	7"	1"	247	145	130
SA111T523	SENIOR PLUS 3P AFP NPT BX SANIC TS	10"	3/4"	315	133	130
SA111T823	SENIOR PLUS 3P BFP NPT BX SANIC TS	10"	1"	321	145	130
SA115T523	MASTER PLUS 3P AFP NPT BX SANIC TS	20"	3/4"	571	133	130
SA115T823	MASTER PLUS 3P BFP NPT BX SANIC TS	20"	1"	577	145	130

Some items in the list are subject to minimum order quantities and/or to longer delivery term.





# DUPLEX PLUS 3P BX SANIC

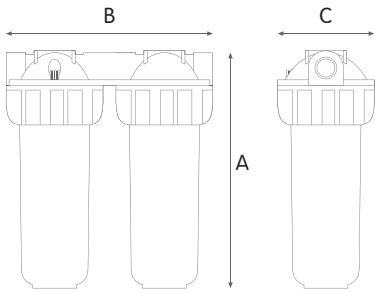

## WORKING CONDITIONS

Max working pressure:  
 BSP versions \_\_\_\_\_ 8 bar (116 psi)  
 NPT versions \_\_\_\_\_ 8,6 bar (125 psi)  
 Max working temperature \_\_\_\_\_ 45°C (113°F)  
 Min working temperature \_\_\_\_\_ 4°C (39,2°F)

## SPECIFICATIONS

Non-toxic materials, suitable for drinking water.  
 Head and ring nut: reinforced polypropylene.  
 Bowl: PET with antimicrobial technology.  
 O-ring: EPDM.  
 Breather-valve: body polypropylene, o-ring EPDM.  
 IN/OUT brass threads: CW 617 N brass.

## DUPLEX PLUS 3P BX SANIC

### HOUSINGS WITH BRASS BSP THREADS

CODE	MODEL	SUITABLE CARTRIDGE	IN/OUT	DIMENSIONS mm		
				A	B	C
SA108T421	MEDIUM DUPLEX PLUS 3P AFO BX SANIC TS	5"	3/4"	191	275	130
SA108T721	MEDIUM DUPLEX PLUS 3P BFO BX SANIC TS	5"	1"	191	275	130
SA110T421	JUNIOR DUPLEX PLUS 3P AFO BX SANIC TS	7"	3/4"	241	275	130
SA110T721	JUNIOR DUPLEX PLUS 3P BFO BX SANIC TS	7"	1"	241	275	130
SA112T421	SENIOR DUPLEX PLUS 3P AFO BX SANIC TS	10"	3/4"	315	275	130
SA112T721	SENIOR DUPLEX PLUS 3P BFO BX SANIC TS	10"	1"	315	275	130
SA116T421	MASTER DUPLEX PLUS 3P AFO BX SANIC TS	20"	3/4"	571	275	130
SA116T721	MASTER DUPLEX PLUS 3P BFO BX SANIC TS	20"	1"	571	275	130

### HOUSINGS WITH PLASTIC BSP THREADS

CODE	MODEL	SUITABLE CARTRIDGE	IN/OUT	DIMENSIONS mm		
				A	B	C
SA108T521	MEDIUM DUPLEX PLUS 3P AFP BX SANIC TS	5"	3/4"	191	275	130
SA110T521	JUNIOR DUPLEX PLUS 3P AFP BX SANIC TS	7"	3/4"	241	275	130
SA112T521	SENIOR DUPLEX PLUS 3P AFP BX SANIC TS	10"	3/4"	315	275	130
SA116T521	MASTER DUPLEX PLUS 3P AFP BX SANIC TS	20"	3/4"	571	275	130

### HOUSINGS WITH PLASTIC NPT THREADS

CODE	MODEL	SUITABLE CARTRIDGE	IN/OUT	DIMENSIONS mm		
				A	B	C
SA108T424	MEDIUM DUPLEX PLUS 3P AFP NPT BX SANIC TS	5"	3/4"	191	275	130
SA110T424	JUNIOR DUPLEX PLUS 3P AFP NPT BX SANIC TS	7"	3/4"	241	275	130
SA112T424	SENIOR DUPLEX PLUS 3P AFP NPT BX SANIC TS	10"	3/4"	315	275	130
SA116T424	MASTER DUPLEX PLUS 3P AFP NPT BX SANIC TS	20"	3/4"	571	275	130

Some items in the list are subject to minimum order quantities and/or to longer delivery term.



# TRIPLEX PLUS 3P BX SANIC

## WORKING CONDITIONS

Max working pressure:  
 BSP versions \_\_\_\_\_ 8 bar (116 psi)  
 NPT versions \_\_\_\_\_ 8,6 bar (125 psi)  
 Max working temperature \_\_\_\_\_ 45°C (113°F)  
 Min working temperature \_\_\_\_\_ 4°C (39,2°F)

## SPECIFICATIONS

Non-toxic materials, suitable for drinking water.  
 Head and ring nut: reinforced polypropylene.  
 Bowl: PET with antimicrobial technology.  
 O-ring: EPDM.  
 Breather-valve: body polypropylene, o-ring EPDM.  
 IN/OUT brass threads: CW 617 N brass.

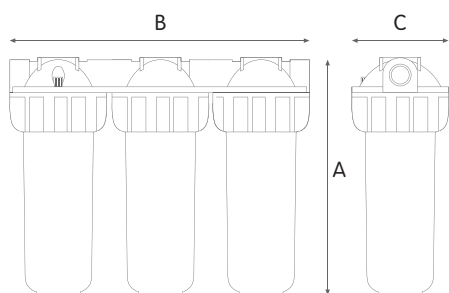

## TRIPLEX PLUS 3P BX SANIC

### HOUSINGS WITH BRASS BSP THREADS

CODE	MODEL	SUITABLE CARTRIDGE	IN/OUT	DIMENSIONS mm		
				A	B	C
SA108T441	MEDIUM TRIPLEX PLUS 3P AFO BX SANIC TS	5"	3/4"	191	420	130
SA108T741	MEDIUM TRIPLEX PLUS 3P BFO BX SANIC TS	5"	1"	191	420	130
SA110T441	JUNIOR TRIPLEX PLUS 3P AFO BX SANIC TS	7"	3/4"	241	420	130
SA110T741	JUNIOR TRIPLEX PLUS 3P BFO BX SANIC TS	7"	1"	241	420	130
SA112T441	SENIOR TRIPLEX PLUS 3P AFO BX SANIC TS	10"	3/4"	315	420	130
SA112T741	SENIOR TRIPLEX PLUS 3P BFO BX SANIC TS	10"	1"	315	420	130
SA116T441	MASTER TRIPLEX PLUS 3P AFO BX SANIC TS	20"	3/4"	571	420	130
SA116T741	MASTER TRIPLEX PLUS 3P BFO BX SANIC TS	20"	1"	571	420	130



### HOUSINGS WITH PLASTIC BSP THREADS

CODE	MODEL	SUITABLE CARTRIDGE	IN/OUT	DIMENSIONS mm		
				A	B	C
SA108T541	MEDIUM TRIPLEX PLUS 3P AFP BX SANIC TS	5"	3/4"	191	420	130
SA108T841	MEDIUM TRIPLEX PLUS 3P BFP BX SANIC TS	5"	1"	191	420	130
SA110T541	JUNIOR TRIPLEX PLUS 3P AFP BX SANIC TS	7"	3/4"	241	420	130
SA110T841	JUNIOR TRIPLEX PLUS 3P BFP BX SANIC TS	7"	1"	241	420	130
SA112T541	SENIOR TRIPLEX PLUS 3P AFP BX SANIC TS	10"	3/4"	315	420	130
SA112T841	SENIOR TRIPLEX PLUS 3P BFP BX SANIC TS	10"	1"	315	420	130
SA116T541	MASTER TRIPLEX PLUS 3P AFP BX SANIC TS	20"	3/4"	571	420	130
SA116T841	MASTER TRIPLEX PLUS 3P BFP BX SANIC TS	20"	1"	571	420	130



### HOUSINGS WITH PLASTIC NPT THREADS

CODE	MODEL	SUITABLE CARTRIDGE	IN/OUT	DIMENSIONS mm		
				A	B	C
SA108T444	MEDIUM TRIPLEX PLUS 3P AFP NPT BX SANIC TS	5"	3/4"	191	420	130
SA110T444	JUNIOR TRIPLEX PLUS 3P AFP NPT BX SANIC TS	7"	3/4"	241	420	130
SA112T444	SENIOR TRIPLEX PLUS 3P AFP NPT BX SANIC TS	10"	3/4"	315	420	130
SA116T444	MASTER TRIPLEX PLUS 3P AFP NPT BX SANIC TS	20"	3/4"	571	420	130

Some items in the list are subject to minimum order quantities and/or to longer delivery term.





# MIGNON PLUS

filter housings for cartridges MIGNON SX

MIGNON PLUS is a range of single and Duplex housings with reduced dimensions designed to fit to exclusive 5" M SX (DOE) cartridges with OD (outer diameter) 50 mm, height 5"

# HOUSINGS MIGNON PLUS

## FOR CARTRIDGES MIGNON SX

Housings MIGNON PLUS SX fit to exclusive 5" M SX (DOE) cartridges with OD (outer diameter) 50 mm, height 5".

A wide range of Atlas Filtri® MIGNON SX cartridges is suitable to MIGNON PLUS housings and provide a full range of water filtration and treatment units.



## MIGNON SX

cartridges with standard flat seals.

The housings are made in 2 main versions 3P and 2P with 3 IN/OUT ports configurations:

- **L** models with in-line connections, IN/OUT at 1/2" and 3/4".
- **S** models with 90° connections, IN/OUT at 1/2".
- **SL** models with 3 ports connections, IN/OUT at 1/2".



Mignon PLUS L

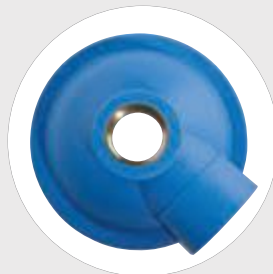

Mignon PLUS S



Mignon PLUS SL

MIGNON PLUS SX housings are manufactured with the finest and most advanced materials under constant focus on innovative processing technologies and ceaseless modernization to ensure the absolute quality of our products.

## ACCESSORIES ON DEMAND



-L- spanner for Mignon 3P CODE RB7403001



-M- spanner for Mignon 2P RB7403002



wall bracket Mignon Duplex CODE RB7400006



3/4" brass nipple with o-ring (pair) CODE RB7404001



3/4" plastic nipple with o-ring CODE LB7404012



3/4"-1/4" plastic reduction with o-ring CODE LB9020611



diffuser tube Mignon CODE LB7405001



-LUBRIKIT- single-dose lubricant for housing o-ring CODE RE9020650

## CERTIFICATIONS



Housings are tested and certified under the most stringent procedures worldwide, in compliance with DM 25 (Italy), with the sanitary certification ACS (France), EAC/Ghostreghistrizia (Russia) and WaterMark (Australia).

## SYMBOLS LEGEND



For domestic use



For technical and industrial use

HOUSINGS RANGE



**MIGNON**  
HOUSINGS MODEL

**PLUS L**  
PORTS TYPE

**3P**  
VERSION

**M**  
IN / OUT

**FO**  
THREADS TYPE

**AS**  
BOWL TYPE

PLUS L



PLUS S



PLUS SL



3P



2P



M 1/2"

A 3/4"

FO - BRASS BSP \*

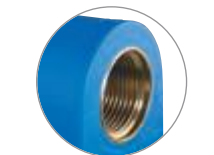

AS - CLEAR (SAN)



AB - BLUE (PP)

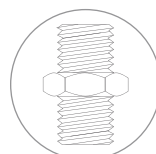
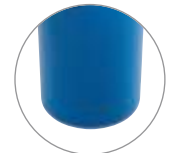

\* **BSP**  
parallel (cylindrical)  
ISO 228





# MIGNON PLUS 3P

## WORKING CONDITIONS

Max working pressure \_\_\_\_\_ 8 bar (116 psi)  
 Max working temperature \_\_\_\_\_ 45°C (113°F)  
 Min working temperature \_\_\_\_\_ 4°C (39,2°F)

## SPECIFICATIONS

Non-toxic materials, suitable for drinking water.  
 Head and ring nut: reinforced polypropylene.  
 Bowl AS: SAN.  
 Bowl AB: reinforced polypropylene.  
 O-ring: EPDM.  
 Breather-valve (only Duplex): body polypropylene,  
 o-ring EPDM.  
 IN/OUT brass threads: CW 617 N brass.

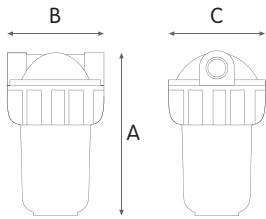

## 2 PORTS HEADS

### MIGNON PLUS 3P clear housings

#### HOUSINGS WITH BRASS BSP THREADS

CODE	MODEL	SUITABLE CARTRIDGE	IN/OUT	DIMENSIONS mm		
				A	B	C
RA101P111	MIGNON PLUS L3P MFO AS	5" M	1/2"	176	94	89
RA101P411	MIGNON PLUS L3P AFO AS	5" M	3/4"	178	94	89
RA103P111	MIGNON PLUS S3P MFO AS	5" M	1/2"	177	90	89



### MIGNON PLUS 3P blue housings

#### HOUSINGS WITH BRASS BSP THREADS

CODE	MODEL	SUITABLE CARTRIDGE	IN/OUT	DIMENSIONS mm		
				A	B	C
RA101P112	MIGNON PLUS L3P MFO AB	5" M	1/2"	176	94	89
RA101P412	MIGNON PLUS L3P AFO AB	5" M	3/4"	178	94	89
RA103P112	MIGNON PLUS S3P MFO AB	5" M	1/2"	177	90	89

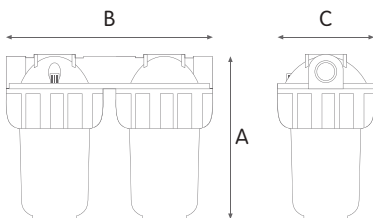

# MIGNON DUPLEX PLUS 3P

### MIGNON DUPLEX PLUS 3P clear housings

#### HOUSINGS WITH BRASS BSP THREADS

CODE	MODEL	SUITABLE CARTRIDGE	IN/OUT	DIMENSIONS mm		
				A	B	C
RA102P111	MIGNON DUPLEX PLUS L3P MFO AS	5" M	1/2"	176	194	89



### MIGNON DUPLEX PLUS 3P blue housings

#### HOUSINGS WITH BRASS BSP THREADS

CODE	MODEL	SUITABLE CARTRIDGE	IN/OUT	DIMENSIONS mm		
				A	B	C
RA102P112	MIGNON DUPLEX PLUS L3P MFO AB	5" M	1/2"	176	194	89





# MIGNON PLUS 2P

## WORKING CONDITIONS

Max working pressure \_\_\_\_\_ 8 bar (116 psi)  
 Max working temperature \_\_\_\_\_ 45°C (113°F)  
 Min working temperature \_\_\_\_\_ 4°C (39,2°F)

## SPECIFICATIONS

Non-toxic materials, suitable for drinking water.  
 Head: reinforced polypropylene.  
 Bowl AS: SAN.  
 Bowl AB: reinforced polypropylene.  
 O-ring: EPDM.  
 Breather-valve (only Duplex): body polypropylene, o-ring EPDM.  
 IN/OUT brass threads: CW 617 N brass.

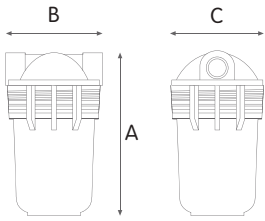

## 2 PORTS HEADS

### MIGNON PLUS 2P clear housings

#### HOUSINGS WITH BRASS BSP THREADS

CODE	MODEL	SUITABLE CARTRIDGE	IN/OUT	DIMENSIONS mm		
				A	B	C
RA104P111	MIGNON PLUS L2P MFO AS	5" M	1/2"	176	94	89
RA104P411	MIGNON PLUS L2P AFO AS	5" M	3/4"	178	94	89
RA106P111	MIGNON PLUS S2P MFO AS	5" M	1/2"	177	90	89



### MIGNON PLUS 2P blue housings

#### HOUSINGS WITH BRASS BSP THREADS

CODE	MODEL	SUITABLE CARTRIDGE	IN/OUT	DIMENSIONS mm		
				A	B	C
RA104P112	MIGNON PLUS L2P MFO AB	5" M	1/2"	176	94	89
RA104P412	MIGNON PLUS L2P AFO AB	5" M	3/4"	178	94	89
RA106P112	MIGNON PLUS S2P MFO AB	5" M	1/2"	177	90	89

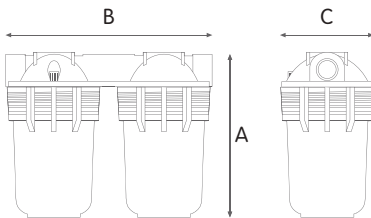

# MIGNON DUPLEX PLUS 2P

### MIGNON DUPLEX PLUS 2P clear housings

#### HOUSINGS WITH BRASS BSP THREADS

CODE	MODEL	SUITABLE CARTRIDGE	IN/OUT	DIMENSIONS mm		
				A	B	C
RA105P111	MIGNON DUPLEX PLUS L2P MFO AS	5" M	1/2"	176	194	89



### MIGNON DUPLEX PLUS 2P blue housings

#### HOUSINGS WITH BRASS BSP THREADS

CODE	MODEL	SUITABLE CARTRIDGE	IN/OUT	DIMENSIONS mm		
				A	B	C
RA105P112	MIGNON DUPLEX PLUS L2P MFO AB	5" M	1/2"	176	194	89





# MIGNON PLUS SL

## WORKING CONDITIONS

Max working pressure \_\_\_\_\_ 8 bar (116 psi)  
 Max working temperature \_\_\_\_\_ 45°C (113°F)  
 Min working temperature \_\_\_\_\_ 4°C (39,2°F)

## SPECIFICATIONS

Non-toxic materials, suitable for drinking water.  
 Head: reinforced polypropylene.  
 Bowl AS: SAN.  
 Bowl AB: reinforced polypropylene.  
 O-ring: EPDM.  
 IN/OUT brass threads: CW 617 N brass.

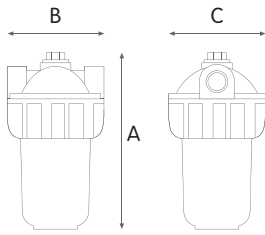

## 3 PORTS HEADS

### MIGNON PLUS SL 3P clear housings

#### HOUSINGS WITH BRASS BSP THREADS

CODE	MODEL	SUITABLE CARTRIDGE	IN/OUT	DIMENSIONS mm		
				A	B	C
RA105P511	MIGNON PLUS SL3P MFO AS	5" M	1/2"	187	92	83



### MIGNON PLUS SL 3P blue housings

#### HOUSINGS WITH BRASS BSP THREADS

CODE	MODEL	SUITABLE CARTRIDGE	IN/OUT	DIMENSIONS mm		
				A	B	C
RA105P512	MIGNON PLUS SL3P MFO AB	5" M	1/2"	187	92	83

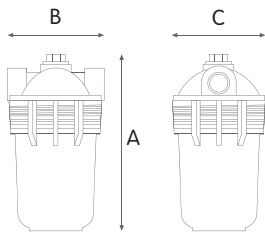

### MIGNON PLUS SL 2P clear housings

#### HOUSINGS WITH BRASS BSP THREADS

CODE	MODEL	SUITABLE CARTRIDGE	IN/OUT	DIMENSIONS mm		
				A	B	C
RA105P611	MIGNON PLUS SL2P MFO AS	5" M	1/2"	192	92	83



### MIGNON PLUS SL 2P blue housings

#### HOUSINGS WITH BRASS BSP THREADS

CODE	MODEL	SUITABLE CARTRIDGE	IN/OUT	DIMENSIONS mm		
				A	B	C
RA105P612	MIGNON PLUS SL2P MFO AB	5" M	1/2"	192	92	83





# MICRO 3/8

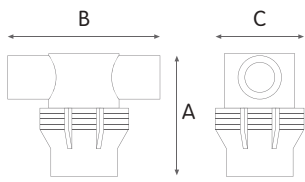

## WORKING CONDITIONS

Max working pressure \_\_\_\_\_ 7 bar (101 psi)  
 Max working temperature \_\_\_\_\_ 45°C (113°F)  
 Min working temperature \_\_\_\_\_ 4°C (39,2°F)

## SPECIFICATIONS

Non-toxic materials, suitable for drinking water.  
 Head: reinforced polypropylene.  
 Bowl: SAN.  
 O-ring: EPDM.  
 GL cartridge: polypropylene.  
 RAM-C cartridge: polypropylene core,  
 stainless steel net AISI 304.

MICRO is the smaller filter in Atlas Filtri range, with 3/8" plastic BSP connection ports and reduced dimensions is particularly designed for every application where space availability is the issue, such as water cleaners, pressure-washers and micro-irrigation, amongst many others.



## MICRO 3/8

### FILTER WITH PLASTIC BSP THREADS

CODE	MODEL	NOMINAL FILTRATION MICRON	IN/OUT	FLOW RATE	DIMENSIONS mm		
					A	B	C
RE6300200	MICRO 3/8 GL	1000	3/8"	600	65	75	50
RE6300210	MICRO 3/8 RAM-C	300	3/8"	500	65	75	50



**GL cartridge**  
 polypropylene  
 CODE RE6300205



**RAM-C cartridge**  
 stainless steel net AISI 304  
 CODE RE6300215



### VARIANTS AVAILABLE ON MINIMUM QUANTITY:

- RAM-A cartridge with stainless steel net AISI 316.
- RAM-C stainless steel filters available on demand with filtration at 100, 200, 400 or 500 micron.



# PLUS HOT 3P

filter housings  
for cartridges SX and BX

Range of housings  
applicable for hot water filtration





# HOUSINGS PLUS HOT 3P

FOR CARTRIDGES SX AND BX

**Housings PLUS HOT 3P fit to standard SX (DOE) cartridges** applicable for hot water filtration: FA-HOT SX wound polypropylene cartridges, CPP SX polypropylene melt-blown cartridges, RA SX stainless steel net cartridges.

**Housings PLUS HOT S 3P with discharge valve fit to washable RA BX stainless steel net cartridges** BX cartridges with 45 mm double o-ring collar applicable for hot water filtration.

**Housings PLUS HOT S 3P BX** are provided with a drain funnel to protect water from pollution by back-flow, in compliance with **UNI EN 1717-11/2002**.



**SX** cartridges with standard flat seals.



**BX** cartridges with 45 mm double o-ring collar. Quick-fit connection for a perfect tightening.

PLUS HOT 3P housings are manufactured with the finest and most advanced materials under constant focus on innovative processing technologies and ceaseless modernization to ensure the absolute quality of our products.

## CERTIFICATIONS



A range of housings is certified by IAPMO RT to NSF/ANSI 42 - Structural Integrity Only and CSA B483.1 - Structural Integrity Only. In compliance with Drinking Water Treatment Units regulations, USA and Canada.



Housings are tested and certified in compliance with the sanitary certification EAC/Ghostreghistrizia (Russia) and WaterMark (Australia).

## ACCESSORIES ON DEMAND



-N- spanner CODE RB7403004



-S- wall bracket CODE RB7400007



-LUBRIKIT- single-dose lubricant for housing o-ring  
CODE RE9020650

## ACCESSORY INCLUDED

### DISCHARGE KIT FOR -S- MODEL



brass discharge ball-valve with gasket

plastic hose-holder

plastic nipple with o-ring



drain funnel

In compliance with the European Standard UNI EN 1717/2002: designed to prevent back-flow contamination by making all elements downstream the discharge vent to atmosphere (protection unit symbol: DC)

## SYMBOLS LEGEND



For domestic use



For technical and industrial use

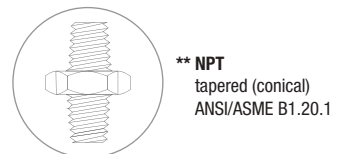
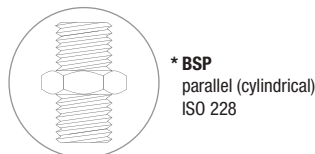
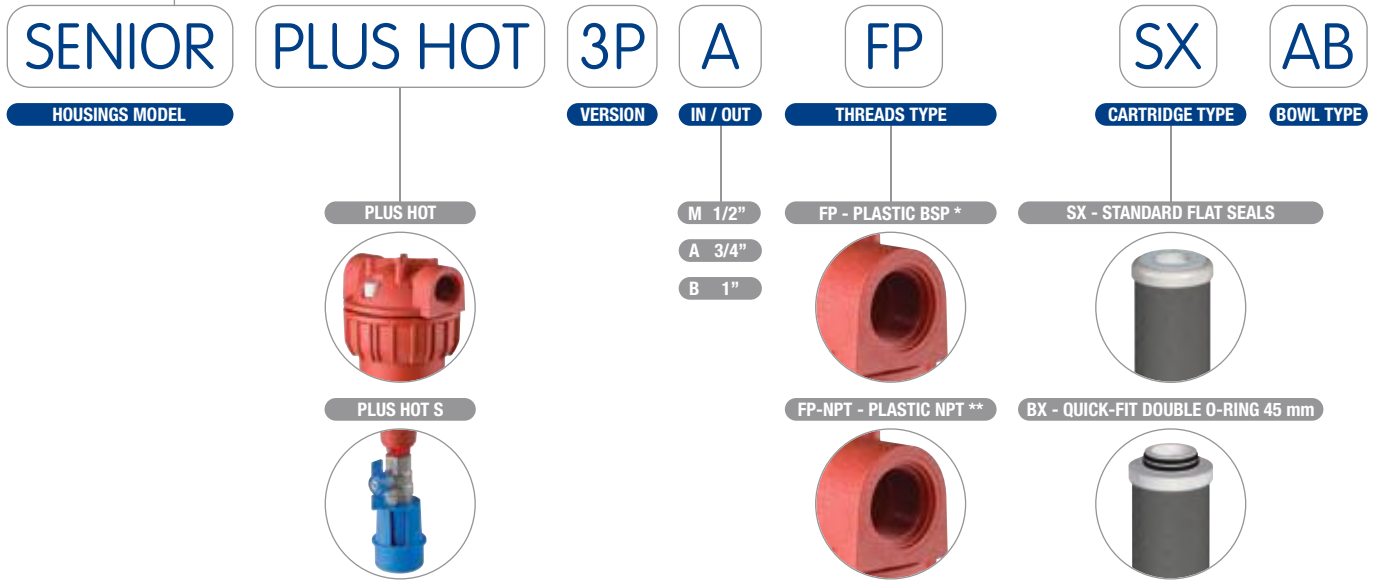
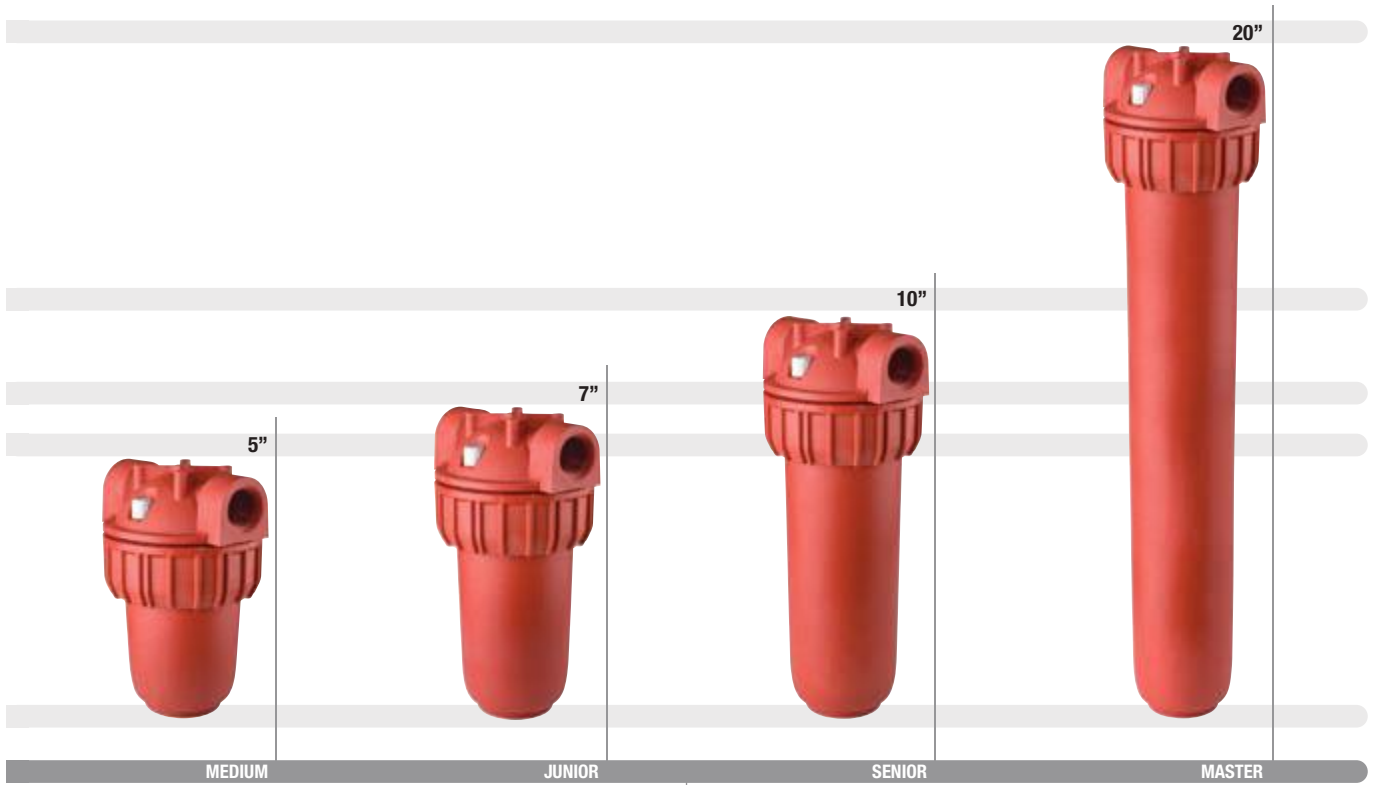



# PLUS HOT 3P SX

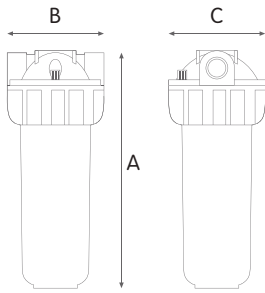

### WORKING CONDITIONS

Max working pressure \_\_\_\_\_ 8,6 bar (125 psi)  
 Max working temperature \_\_\_\_\_ 80°C (176°F)  
 Min working temperature \_\_\_\_\_ 4°C (39,2°F)

### SPECIFICATIONS

Non-toxic materials.  
 Head and ring nut: reinforced nylon.  
 Bowl: reinforced nylon.  
 O-ring: EPDM.  
 Breather-valve: body polypropylene, o-ring EPDM.

## PLUS HOT 3P SX

### HOUSINGS WITH PLASTIC BSP THREADS

CODE	MODEL	SUITABLE CARTRIDGE	IN/OUT	DIMENSIONS mm		
				A	B	C
RA107P209	MEDIUM PLUS HOT 3P MFP SX AB	5"	1/2"	191	133	130
RA107P509	MEDIUM PLUS HOT 3P AFP SX AB	5"	3/4"	191	133	130
RA107P809	MEDIUM PLUS HOT 3P BFP SX AB	5"	1"	197	145	130
RA109P209	JUNIOR PLUS HOT 3P MFP SX AB	7"	1/2"	241	133	130
RA109P509	JUNIOR PLUS HOT 3P AFP SX AB	7"	3/4"	241	133	130
RA109P809	JUNIOR PLUS HOT 3P BFP SX AB	7"	1"	247	145	130
RA111P218	SENIOR PLUS HOT 3P MFP SX AB	10"	1/2"	315	133	130
RA111P518	SENIOR PLUS HOT 3P AFP SX AB	10"	3/4"	315	133	130
RA111P718	SENIOR PLUS HOT 3P BFP SX AB	10"	1"	321	145	130
RA115P218	MASTER PLUS HOT 3P MFP SX AB	20"	1/2"	571	133	130
RA115P518	MASTER PLUS HOT 3P AFP SX AB	20"	3/4"	571	133	130
RA115P718	MASTER PLUS HOT 3P BFP SX AB	20"	1"	577	145	130

### HOUSINGS WITH PLASTIC NPT THREADS

CODE	MODEL	SUITABLE CARTRIDGE	IN/OUT	DIMENSIONS mm		
				A	B	C
RA107P510	MEDIUM PLUS HOT 3P AFP NPT SX AB	5"	3/4"	191	133	130
RA107P810	MEDIUM PLUS HOT 3P BFP NPT SX AB	5"	1"	197	145	130
RA109P510	JUNIOR PLUS HOT 3P AFP NPT SX AB	7"	3/4"	241	133	130
RA109P810	JUNIOR PLUS HOT 3P BFP NPT SX AB	7"	1"	247	145	130
RA111P510	SENIOR PLUS HOT 3P AFP NPT SX AB	10"	3/4"	315	133	130
RA111P710	SENIOR PLUS HOT 3P BFP NPT SX AB	10"	1"	321	145	130
RA115P510	MASTER PLUS HOT 3P AFP NPT SX AB	20"	3/4"	571	133	130
RA115P710	MASTER PLUS HOT 3P BFP NPT SX AB	20"	1"	577	145	130



# PLUS HOT S 3P BX

SPECIAL FILTER HOUSINGS

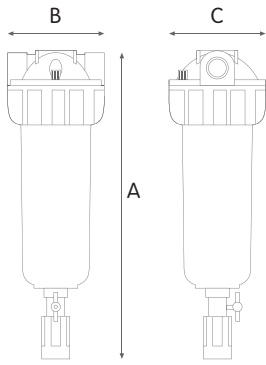

## SPECIFICATIONS

Max working pressure \_\_\_\_\_ 8,6 bar (125 psi)  
 Max working temperature \_\_\_\_\_ 80°C (176°F)  
 Min working temperature \_\_\_\_\_ 4°C (39,2°F)

Non-toxic materials.  
 Head and ring nut: reinforced nylon.  
 Bowl: reinforced nylon.  
 O-ring: EPDM.  
 Breather-valve: body polypropylene, o-ring EPDM.  
 Discharge ball-valve: CW 617 N brass nickel plated.  
 Discharge plastic nipple: reinforced polypropylene.  
 Drain funnel: reinforced polypropylene.



**DRAIN FUNNEL**  
 Back-flow preventing device  
 UNI EN 1717-11/2002

## PLUS HOT S 3P BX with discharge valve

### HOUSINGS WITH PLASTIC BSP THREADS

CODE	MODEL	SUITABLE CARTRIDGE	IN/OUT	DIMENSIONS mm		
				A	B	C
RA111P238	SENIOR PLUS HOT S 3P MFP BX AB	10"	1/2"	450	133	130
RA111P538	SENIOR PLUS HOT S 3P AFP BX AB	10"	3/4"	450	133	130
RA111P738	SENIOR PLUS HOT S 3P BFP BX AB	10"	1"	460	145	130
RA115P238	MASTER PLUS HOT S 3P MFP BX AB	20"	1/2"	710	133	130
RA115P538	MASTER PLUS HOT S 3P AFP BX AB	20"	3/4"	710	133	130
RA115P738	MASTER PLUS HOT S 3P BFP BX AB	20"	1"	720	145	130

### HOUSINGS WITH PLASTIC NPT THREADS

CODE	MODEL	SUITABLE CARTRIDGE	IN/OUT	DIMENSIONS mm		
				A	B	C
RA111P540	SENIOR PLUS HOT S 3P AFP NPT BX AB	10"	3/4"	450	133	130
RA111P740	SENIOR PLUS HOT S 3P BFP NPT BX AB	10"	1"	460	145	130
RA115P540	MASTER PLUS HOT S 3P AFP NPT BX AB	20"	3/4"	710	133	130
RA115P740	MASTER PLUS HOT S 3P BFP NPT BX AB	20"	1"	720	145	130

Some items in the list are subject to minimum order quantities and/or to longer delivery term.



# 3P PP

filter housings for cartridges SX

Range of single and Duplex housings applicable for the filtration of water with non-neutral pH and for other liquids





# HOUSINGS 3P PP

## FOR CARTRIDGES SX

**Housings 3P PP fit to standard SX (DOE) cartridges** FA wound polypropylene, CPP polypropylene melt-blown and AC multilayer.



**SX** cartridges with standard flat seals.

3P PP is a range of single and Duplex housings applicable for the filtration of water with non-neutral pH and for other liquids.

The housings are made in 2 main versions:

- **3P PP** housings with standard EPDM o-ring, for standard application in water filtration.
- **3P PP V** housings VITON® o-ring, for application with non-neutral water.

PP 3P housings and are manufactured with the finest and most advanced materials under constant focus on innovative processing technologies and ceaseless modernization to ensure the absolute quality of our products

## ACCESSORIES ON DEMAND



-U- spanner CODE RB7403013



-S- wall bracket CODE RB7400007



-D- wall bracket CODE RB7400009



-LUBRIKIT- single-dose lubricant for housing o-ring  
CODE RE9020650

## CERTIFICATIONS



Housings are tested and certified in compliance with the sanitary certification EAC/Ghostreghistrizia (Russia) and WaterMark (Australia).

## SYMBOLS LEGEND



For domestic use



For technical and industrial use



MIGNON S      MIGNON L      MEDIUM      JUNIOR      SENIOR      MASTER

<b>SENIOR</b>	<b>3P</b>	<b>A</b>	<b>FP</b>	<b>SX</b>	<b>PP</b>
<b>HOUSINGS MODEL</b>	<b>VERSION</b>	<b>IN / OUT</b>	<b>THREADS TYPE</b>	<b>CARTRIDGE TYPE</b>	<b>BOWL TYPE</b>
<ul style="list-style-type: none"> <li>MIGNON DUPLEX</li> <li>MEDIUM DUPLEX</li> <li>JUNIOR DUPLEX</li> <li>SENIOR DUPLEX</li> <li>MASTER DUPLEX</li> </ul> 	<ul style="list-style-type: none"> <li>3P</li> <li>L 3P MIGNON</li> <li>S 3P MIGNON</li> </ul>  	<ul style="list-style-type: none"> <li>M 1/2"</li> <li>A 3/4"</li> <li>B 1"</li> </ul>	<ul style="list-style-type: none"> <li>FP - PLASTIC BSP *</li> </ul> 	<ul style="list-style-type: none"> <li>SX - STANDARD FLAT SEALS</li> </ul> 	<ul style="list-style-type: none"> <li>PP WITH EPDM O-RING</li> <li>PP-V WITH VITON® O-RING</li> </ul>  

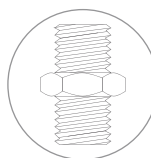

\* BSP  
parallel (cylindrical)  
ISO 228



# 3P SX PP

## WORKING CONDITIONS

Max working pressure in water with neutral pH \_\_\_\_\_ 8 bar (116 psi)  
 Max working pressure in water with non-neutral pH \_\_\_\_\_ 3 bar (43 psi)  
 Max working temperature \_\_\_\_\_ 35°C (95°F)  
 Min working temperature \_\_\_\_\_ 4°C (39,2°F)

## SPECIFICATIONS

Non-toxic materials, suitable for drinking water.  
 Head and ring nut: polypropylene.  
 Bowl: polypropylene.  
 O-ring: EPDM.  
 Breather-valve: polypropylene, o-ring EPDM.

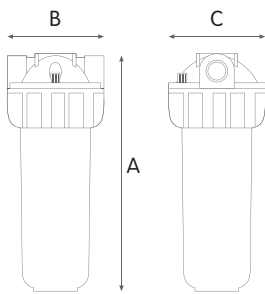

## 3P SX PP housings

### HOUSINGS WITH PLASTIC BSP THREADS

CODE	MODEL	SUITABLE CARTRIDGE	IN/OUT	DIMENSIONS mm		
				A	B	C
RA1010213	MIGNON L 3P MFP PP	5" M	1/2"	176	94	89
RA1030213	MIGNON S 3P MFP PP	5" M	1/2"	176	90	89
RA1070513	MEDIUM 3P AFP SX PP	5"	3/4"	191	133	130
RA1070813	MEDIUM 3P BFP SX PP	5"	1"	197	145	130
RA1090513	JUNIOR 3P AFP SX PP	7"	3/4"	241	133	130
RA1090813	JUNIOR 3P BFP SX PP	7"	1"	247	145	130
RA1110513	SENIOR 3P AFP SX PP	10"	3/4"	315	133	130
RA1110813	SENIOR 3P BFP SX PP	10"	1"	321	145	130
RA1150513	MASTER 3P AFP SX PP	20"	3/4"	571	133	130
RA1150813	MASTER 3P BFP SX PP	20"	1"	577	145	130

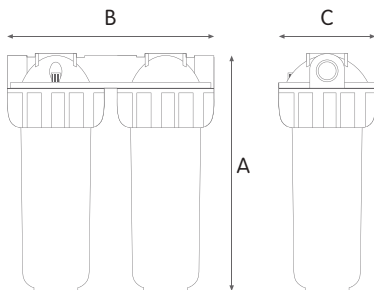

## 3P DUPLEX SX PP housings

### HOUSINGS WITH PLASTIC BSP THREADS

CODE	MODEL	SUITABLE CARTRIDGE	IN/OUT	DIMENSIONS mm		
				A	B	C
RA1020213	MIGNON DUPLEX 3P MFP PP	5" M	1/2"	176	194	89
RA1080513	MEDIUM DUPLEX 3P AFP SX PP	5"	3/4"	191	275	130
RA1100513	JUNIOR DUPLEX 3P AFP SX PP	7"	3/4"	241	275	130
RA1120513	SENIOR DUPLEX 3P AFP SX PP	10"	3/4"	315	275	130
RA1160513	MASTER DUPLEX 3P AFP SX PP	20"	3/4"	571	275	130

### VARIANTS AVAILABLE ON MINIMUM QUANTITY:

- 3P BX PP housings
- 2P SX PP housings



# 3P SX PP V

## WORKING CONDITIONS

Max working pressure in water with neutral pH \_\_\_\_\_ 8 bar (116 psi)  
 Max working pressure in water with non-neutral pH \_\_\_\_\_ 3 bar (43 psi)  
 Max working temperature \_\_\_\_\_ 35°C (95°F)  
 Min working temperature \_\_\_\_\_ 4°C (39,2°F)

## SPECIFICATIONS

Non-toxic materials, suitable for drinking water.  
 Head and ring nut: polypropylene.  
 Bowl: polypropylene.  
 O-ring: Viton®.  
 Breather-valve: polypropylene, o-ring Viton®.

SPECIAL FILTER HOUSINGS

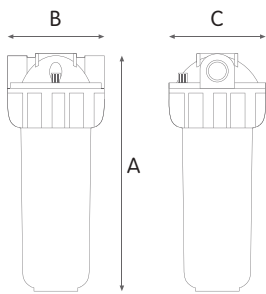

## 3P SX PP V housings

### HOUSINGS WITH PLASTIC BSP THREADS

CODE	MODEL	SUITABLE CARTRIDGE	IN/OUT	DIMENSIONS mm		
				A	B	C
RA1010219	MIGNON L 3P MFP PP V	5" M	1/2"	176	94	89
RA1030219	MIGNON S 3P MFP PP V	5" M	1/2"	176	90	89
RA1070519	MEDIUM 3P AFP SX PP V	5"	3/4"	191	133	130
RA1070819	MEDIUM 3P BFP SX PP V	5"	1"	197	145	130
RA1090519	JUNIOR 3P AFP SX PP V	7"	3/4"	241	133	130
RA1090819	JUNIOR 3P BFP SX PP V	7"	1"	247	145	130
RA1110519	SENIOR 3P AFP SX PP V	10"	3/4"	315	133	130
RA1110819	SENIOR 3P BFP SX PP V	10"	1"	321	145	130
RA1150519	MASTER 3P AFP SX PP V	20"	3/4"	571	133	130
RA1150819	MASTER 3P BFP SX PP V	20"	1"	577	145	130

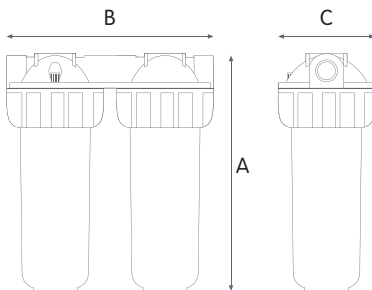

# DUPLEX 3P SX PP V

## DUPLEX 3P SX PP V housings

### HOUSINGS WITH PLASTIC BSP THREADS

CODE	MODEL	SUITABLE CARTRIDGE	IN/OUT	DIMENSIONS mm		
				A	B	C
RA1020219	MIGNON DUPLEX 3P MFP PP V	5" M	1/2"	176	194	89
RA1080519	MEDIUM DUPLEX 3P AFP SX PP V	5"	3/4"	191	275	130
RA1100519	JUNIOR DUPLEX 3P AFP SX PP V	7"	3/4"	241	275	130
RA1120519	SENIOR DUPLEX 3P AFP SX PP V	10"	3/4"	315	275	130
RA1160519	MASTER DUPLEX 3P AFP SX PP V	20"	3/4"	571	275	130

### VARIANTS AVAILABLE ON MINIMUM QUANTITY:

- 3P BX PP V housings
- 2P SX PP V housings

Some items in the list are subject to minimum order quantities and/or to longer delivery term.





## K DP

filter housings  
for cartridges SX, BX and CX

K DP is a range of housings  
with brass head  
designed to withstand working pressure  
up to 10 bar



# HOUSINGS K DP

FOR CARTRIDGES SX, BX AND CX

**Housings K DP SX/BX fit to standard SX (DOE) cartridges and to exclusive BX cartridges with 45 mm double o-ring collar** (female IN/OUT connections at 3/4" and 1", BSP threads).

**Housings K DP CX fit to exclusive CX cartridges with 57 mm double o-ring collar** (female IN/OUT connections at 1"1/2 and 2", BSP threads).

A very wide range of Atlas Filtri BX and CX cartridges is available for K DP housings and provides a complete range of water filtration units.

**Housings K DP with discharge valve** are provided with a drain funnel to protect potable water from pollution by back-flow, in compliance with **UNI EN 1717-11/2002**.

K DP housings are manufactured with the finest and most advanced materials under constant focus on innovative processing technologies and ceaseless modernization to ensure the absolute quality of our products.



**SX** cartridges with standard flat seals.



**BX** cartridges with 45 mm double o-ring collar. Quick-fit connection for a perfect tightening.



**CX** cartridges with 57 mm double o-ring collar. Quick-fit connection for a perfect tightening and designed to suit to large water flow.

## CERTIFICATIONS



Housings are tested and certified under the most stringent procedures worldwide, in compliance with **DM 25 (Italy)**, with the sanitary certification **EAC/ Ghostreghistracia (Russia)** and **WaterMark (Australia)**.

## SYMBOLS LEGEND



For domestic use



For technical and industrial use



Filter housings made in PET, a highly recyclable plastic, are manufactured with a proprietary procedure saving up to 60% of energy in injection molding compared with standard plastics. That is one of Atlas Filtri commitments to comply with Kyoto Treaty for the reduction of green house gas (CO<sub>2</sub>) emissions in the atmosphere.

## ACCESSORIES ON DEMAND



-X- spanner CODE RB7403017



-K DP- wall bracket CODE RB7400021



3/4" brass nipples with o-ring (pair) CODE RB7404001

1" brass nipples with o-ring (pair) CODE RB7404002



-KIT AUTO- for S models CODE RE7120024  
automatic discharge kit (see pages 186-187)



-LUBRIKIT- single-dose lubricant for housing o-ring  
CODE RE9020650

## ACCESSORY INCLUDED

### DISCHARGE KIT FOR -S- MODEL



brass discharge ball-valve with gasket

plastic hose-holder

plastic nipple with o-ring



drain funnel

In compliance with the European Standard UNI EN 1717/2002: designed to prevent back-flow contamination by making all elements downstream the discharge vent to atmosphere (protection unit symbol: DC)



<div data-bbox="76 1108 210 1187" data-label="Section-Header"> <h2>K1</h2> </div> <div data-bbox="76 1198 210 1227" data-label="Section-Header"> <h3>IN/OUT MODEL</h3> </div> <div data-bbox="76 1299 210 1444" data-label="List-Group"> <ul style="list-style-type: none"> <li>K1 (3/4")</li> <li>K2 (1")</li> <li>K3 (1 1/2")</li> <li>K4 (2")</li> </ul> </div>	<div data-bbox="252 1108 486 1187" data-label="Section-Header"> <h2>DP</h2> </div> <div data-bbox="252 1198 486 1227" data-label="Section-Header"> <h3>VERSION</h3> </div> <div data-bbox="295 1299 446 1332" data-label="Text"> <p>DP</p> </div> <div data-bbox="295 1332 446 1489" data-label="Image"> </div> <div data-bbox="295 1489 446 1523" data-label="Text"> <p>DP M</p> </div> <div data-bbox="295 1534 446 1680" data-label="Image"> </div> <div data-bbox="295 1691 446 1720" data-label="Text"> <p>DP S</p> </div> <div data-bbox="454 1691 614 1720" data-label="Text"> <p>DP S M</p> </div> <div data-bbox="295 1724 446 1870" data-label="Image"> </div> <div data-bbox="454 1724 614 2094" data-label="Image"> </div>	<div data-bbox="526 1108 758 1187" data-label="Section-Header"> <h2>SENIOR</h2> </div> <div data-bbox="526 1198 758 1227" data-label="Section-Header"> <h3>HOUSINGS MODEL</h3> </div>	<div data-bbox="798 1108 885 1187" data-label="Section-Header"> <h2>A</h2> </div> <div data-bbox="798 1198 885 1227" data-label="Section-Header"> <h3>IN / OUT</h3> </div> <div data-bbox="798 1299 885 1444" data-label="List-Group"> <ul style="list-style-type: none"> <li>A 3/4"</li> <li>B 1"</li> <li>C 1 1/2"</li> <li>D 2"</li> </ul> </div>	<div data-bbox="949 1108 1061 1187" data-label="Section-Header"> <h2>FO</h2> </div> <div data-bbox="949 1198 1061 1227" data-label="Section-Header"> <h3>THREADS TYPE</h3> </div> <div data-bbox="949 1299 1061 1332" data-label="Text"> <p>FO - BRASS BSP *</p> </div> <div data-bbox="925 1332 1085 1489" data-label="Image"> </div>	<div data-bbox="1181 1108 1380 1187" data-label="Section-Header"> <h2>SX/BX</h2> </div> <div data-bbox="1181 1198 1380 1227" data-label="Section-Header"> <h3>CARTRIDGE TYPE</h3> </div> <div data-bbox="1181 1299 1380 1332" data-label="Text"> <p>SX/BX (K1, K2)</p> </div> <div data-bbox="1125 1332 1444 1489" data-label="Image"> </div> <div data-bbox="1181 1489 1380 1523" data-label="Text"> <p>CX (K3, K4)</p> </div> <div data-bbox="1204 1534 1364 1680" data-label="Image"> </div>
--	--	---	--	--	---

\* BSP parallel (cylindrical) ISO 228



# K DP

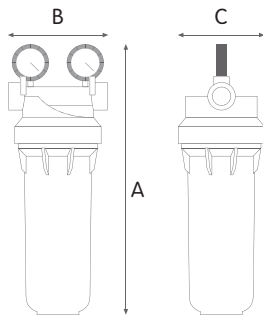
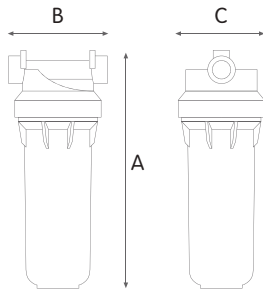

### WORKING CONDITIONS

Max working pressure \_\_\_\_\_ 10 bar (145 psi)  
 Max working temperature \_\_\_\_\_ 45°C (113°F)  
 Min working temperature \_\_\_\_\_ 4°C (39,2°F)

### SPECIFICATIONS

Non-toxic materials, suitable for drinking water.  
 Head and ring nut: CB 753 S brass.  
 Bowl: PET.  
 O-ring: EPDM.  
 Breather-valve: CW 614 N brass.  
 Manometers: radial type, pressure range 0-12 bar, 0-170 psi.

## K DP housings

### HOUSINGS WITH BRASS BSP THREADS

CODE	MODEL	SUITABLE CARTRIDGE	IN/OUT	DIMENSIONS mm		
				A	B	C
RA3170424	K1 DP MEDIUM AFO SX/BX	5"	3/4"	210	120	105
RA3170724	K2 DP MEDIUM BFO SX/BX	5"	1"	210	120	105
RA3180424	K1 DP JUNIOR AFO SX/BX	7"	3/4"	260	120	105
RA3180724	K2 DP JUNIOR BFO SX/BX	7"	1"	260	120	105
RA3210424	K1 DP SENIOR AFO SX/BX	10"	3/4"	335	120	105
RA3210724	K2 DP SENIOR BFO SX/BX	10"	1"	335	120	105
RA3211034	K3 DP SENIOR CFO CX	10"	1"1/2	345	130	105
RA3211134	K4 DP SENIOR DFO CX	10"	2"	350	130	105
RA3250424	K1 DP MASTER AFO SX/BX	20"	3/4"	590	120	105
RA3250724	K2 DP MASTER BFO SX/BX	20"	1"	590	120	105
RA3251034	K3 DP MASTER CFO CX	20"	1"1/2	600	130	105
RA3251134	K4 DP MASTER DFO CX	20"	2"	605	130	105

# K DP M

## K DP M housings with 2 manometers

### HOUSINGS WITH BRASS BSP THREADS

CODE	MODEL	SUITABLE CARTRIDGE	IN/OUT	DIMENSIONS mm		
				A	B	C
RA3170426	K1 DP MEDIUM M AFO SX/BX	5"	3/4"	260	120	105
RA3170726	K2 DP MEDIUM M BFO SX/BX	5"	1"	260	120	105
RA3180426	K1 DP JUNIOR M AFO SX/BX	7"	3/4"	310	120	105
RA3180726	K2 DP JUNIOR M BFO SX/BX	7"	1"	310	120	105
RA3210426	K1 DP SENIOR M AFO SX/BX	10"	3/4"	380	120	105
RA3210726	K2 DP SENIOR M BFO SX/BX	10"	1"	380	120	105
RA3213034	K3 DP SENIOR M CFO CX	10"	1"1/2	390	130	105
RA3213134	K4 DP SENIOR M DFO CX	10"	2"	400	130	105
RA3250426	K1 DP MASTER M AFO SX/BX	20"	3/4"	635	120	105
RA3250726	K2 DP MASTER M BFO SX/BX	20"	1"	635	120	105
RA3253034	K3 DP MASTER M CFO CX	20"	1"1/2	645	130	105
RA3253134	K4 DP MASTER M DFO CX	20"	2"	650	130	105



# K DP S only for BX cartridges

## WORKING CONDITIONS

Max working pressure \_\_\_\_\_ 10 bar (145 psi)  
 Max working temperature \_\_\_\_\_ 45°C (113°F)  
 Min working temperature \_\_\_\_\_ 4°C (39,2°F)

## SPECIFICATIONS

Non-toxic materials, suitable for drinking water.  
 Head and ring nut: CB 753 S brass.  
 Bowl: PET.  
 O-ring: EPDM.  
 Breather-valve: CW 614 N brass.  
 Discharge ball-valve: CW 617 N brass nickel plated.  
 Discharge plastic nipple: reinforced polypropylene.  
 Drain funnel: reinforced polypropylene.  
 Manometers: radial type, pressure range 0-12 bar, 0-170 psi.

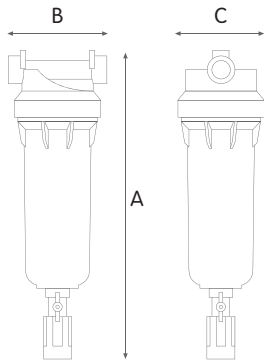

**DRAIN FUNNEL**  
 Back-flow preventing device  
 UNI EN 1717-11/2002

SPECIAL FILTER HOUSINGS

## K DP S housings with discharge valve

### HOUSINGS WITH BRASS BSP THREADS

CODE	MODEL	SUITABLE CARTRIDGE	IN/OUT	DIMENSIONS mm		
				A	B	C
RA3210425	K1 DP SENIOR S AFO SX/BX	10"	3/4"	485	120	105
RA3210725	K2 DP SENIOR S BFO SX/BX	10"	1"	485	120	105
RA3211035	K3 DP SENIOR S CFO CX	10"	1 1/2"	495	130	105
RA3211135	K4 DP SENIOR S DFO CX	10"	2"	505	130	105
RA3250425	K1 DP MASTER S AFO SX/BX	20"	3/4"	740	120	105
RA3250725	K2 DP MASTER S BFO SX/BX	20"	1"	740	120	105
RA3251035	K3 DP MASTER S CFO CX	20"	1 1/2"	750	130	105
RA3251135	K4 DP MASTER S DFO CX	20"	2"	755	130	105

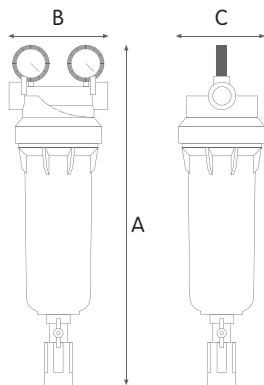

# K DP S M only for BX cartridges

## K DP S M housings with discharge valve and 2 manometers

### HOUSINGS WITH BRASS BSP THREADS

CODE	MODEL	SUITABLE CARTRIDGE	IN/OUT	DIMENSIONS mm		
				A	B	C
RA3210427	K1 DP SENIOR S M AFO SX/BX	10"	3/4"	530	120	105
RA3210727	K2 DP SENIOR S M BFO SX/BX	10"	1"	530	120	105
RA3213035	K3 DP SENIOR S M CFO CX	10"	1 1/2"	540	130	105
RA3213135	K4 DP SENIOR S M DFO CX	10"	2"	550	130	105
RA3250427	K1 DP MASTER S M AFO SX/BX	20"	3/4"	785	120	105
RA3250727	K2 DP MASTER S M BFO SX/BX	20"	1"	785	120	105
RA3253035	K3 DP MASTER S M CFO CX	20"	1 1/2"	795	130	105
RA3253135	K4 DP MASTER S M DFO CX	20"	2"	800	130	105









## FX AF and XX

for cartridges SX, BX, and CX

Range of housings entirely made of metal,  
with stainless steel tightening clamp,  
designed to work at high pressure and temperature



# FX-AF and XX

## FULL METAL HOUSINGS

Housings FX AF with 3/4" and 1" IN/OUT connections fit to exclusive BX cartridges with 45 mm double o-ring collar.

Housings FX AF with 1 1/2" and 2" IN/OUT connections fit to exclusive CX cartridges with 57 mm double o-ring collar.

Housings XX with 1" IN/OUT connections fit to standard SX (DOE) cartridges.

To achieve the higher performances, metal housings feature a stainless steel clamp to provide perfect tightening and resistance in stress conditions



**BX** cartridges with 45 mm double o-ring collar. Quick-fit connection for a perfect tightening.



**SX** cartridges with standard flat seals.

**CX** cartridges with 57 mm double o-ring collar. Quick-fit connection for a perfect tightening and designed to suit to large water flow.

## CERTIFICATIONS



Housings are tested and certified under the most stringent procedures worldwide, in compliance with DM 25 (Italy), with the sanitary certification EAC/ Ghostreghistrizia (Russia) and WaterMark (Australia).

## ACCESSORIES ON DEMAND



-K DP- wall bracket CODE RB7400021



3/4" brass nipples with o-ring (pair) CODE RB7404001

1" brass nipples with o-ring (pair) CODE RB7404002

## SYMBOLS LEGEND



For domestic use



For technical and industrial use



# FX-AF

## WORKING CONDITIONS

Max working pressure \_\_\_\_\_ 16 bar (232 psi)  
 Max working temperature \_\_\_\_\_ 80°C (176°F)  
 Min working temperature \_\_\_\_\_ 4°C (39,2°F)

## SPECIFICATIONS

Non-toxic materials, suitable for drinking water.  
 Head: CB 753 S brass.  
 Bowl: AISI 304 stainless steel.  
 Clamp: AISI 304 stainless steel.  
 Seal: EPDM.

SPECIAL FILTER  
HOUSINGS

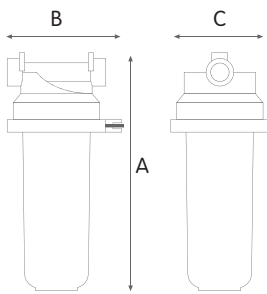

## FX-AF housings with brass head and stainless steel bowl

### HOUSINGS WITH BRASS BSP THREADS

CODE	MODEL	SUITABLE CARTRIDGE	IN/OUT	DIMENSIONS mm		
				A	B	C
RE3200427	FX-AF 310 B BX	10"	3/4"	370	120	105
RE3200727	FX-AF 310 C BX	10"	1"	370	120	105
RE3200837	FX-AF 310 E CX	10"	1 1/2"	375	130	105
RE3200937	FX-AF 310 F CX	10"	2"	385	130	105
RE3201427	FX-AF 320 B BX	20"	3/4"	630	120	105
RE3201727	FX-AF 320 C BX	20"	1"	630	120	105
RE3201837	FX-AF 320 E CX	20"	1 1/2"	635	130	105
RE3201937	FX-AF 320 F CX	20"	2"	645	130	105



XX

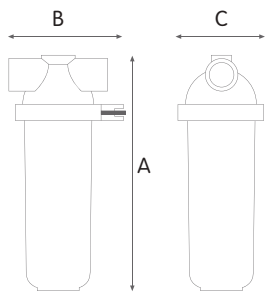

**WORKING CONDITIONS**

Max working pressure \_\_\_\_\_ 25 bar (363 psi)  
 Max working temperature \_\_\_\_\_ 100°C (212°F)  
 Min working temperature \_\_\_\_\_ 4°C (39,2°F)

**SPECIFICATIONS**

Non-toxic materials, suitable for drinking water.  
 Head: AISI 316 stainless steel.  
 Bowl: AISI 316L stainless steel.  
 Clamp: AISI 316L stainless steel.  
 Seal: EPDM.

XX housings with stainless steel head and bowl

**HOUSINGS WITH STAINLESS STEEL BSP THREADS**

CODE	MODEL	SUITABLE CARTRIDGE	IN/OUT	DIMENSIONS mm		
				A	B	C
RE3300716	XX 310 C SX	10"	1"	330	130	105



# DP

filter housings  
for cartridges SX and BX

DP is a full range of housings for cartridge height at 5", 7", 10" and 20", especially designed to fit to both standard SX (DOE) cartridges and to BX cartridges with 45 mm double o-ring collar

# HOUSINGS DP

FOR CARTRIDGES SX and BX

**Housings DP fit to both standard SX (DOE) cartridges and to exclusive BX cartridges.** The full range of Atlas Filtri® SX and BX cartridges is suitable to DP housing and provide the widest range of water filtration and treatment units.

**Exclusive Mono, Duo and Trio patented and registered models** are manufactured with the finest and most advanced materials under constant focus on innovative processing technologies and ceaseless modernization to ensure the absolute quality of our products. DP housings are suitable for every Point-of-Use (POU) and Point-of-Entry (POE) application, as single- or multi-stage on-line filters, under-sink filters, Reverse Osmosis pre-filtration units.

**Housings DP S with discharge valve** are provided with a drain funnel to protect potable water from pollution by back-flow, in compliance with **UNI EN 1717-11/2002**.



**SX** cartridges with standard flat seals.



**BX** cartridges with 45 mm double o-ring collar. Quick-fit connection for a perfect tightening.

## CERTIFICATIONS



A range of housings is certified by IAPMO RT to NSF/ANSI 42, 61, 372 - lead free, CSA B483.1. In compliance with Drinking Water Treatment Units regulations, USA and Canada.



Housings are tested and certified under the most stringent procedures worldwide, in compliance with DM 25 (Italy), with the sanitary certification ACS (France), EAC/Ghostreghistrizia (Russia) and WaterMark (Australia).

## SYMBOLS LEGEND



For domestic use



For technical and industrial use



Filter housings made in PET, a highly recyclable plastic, are manufactured with a proprietary procedure saving up to 60% of energy in injection molding compared with standard plastics. That is one of Atlas Filtri commitments to comply with Kyoto Treaty for the reduction of green house gas (CO<sub>2</sub>) emissions in the atmosphere.

Filter housings made in PET, a highly recyclable plastic, are manufactured with a proprietary procedure saving up to 60% of energy in injection molding compared with standard plastics. That is one of Atlas Filtri commitments to comply with Kyoto Treaty for the reduction of green house gas (CO<sub>2</sub>) emissions in the atmosphere.



Filterfit - cartridge centering device

## ACCESSORIES INCLUDED

### DISCHARGE KIT FOR -S- MODELS



brass discharge ball-valve with gasket



plastic hose-holder



plastic nipple with o-ring



drain funnel

In compliance with the European Standard UNI EN 1717/2002: designed to prevent back-flow contamination by making all elements downstream the discharge vent to atmosphere (protection unit symbol: DC)

## ACCESSORIES ON DEMAND

\* white colour provided with housings BW (white)

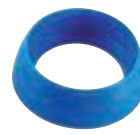

DP-base\* (only for DP 10 models)  
CODE LB7402014



-X- spanner\*  
CODE RB7403017



-S- wall bracket\* CODE RB7400007



-DUO- wall bracket\* CODE RB7400017



-TRIO- wall bracket\* CODE RB7400019



3/4" brass nipples with o-ring (pair) CODE RB7404001

1" brass nipples with o-ring (pair) CODE RB7404002



3/4" plastic nipple with o-ring CODE LB7404012



3/4"-1/4" plastic reduction with o-ring CODE LB9020611



-KIT AUTO- for S models CODE RE7120024  
automatic discharge kit (see pages 186-187)



-LUBRIKIT- single-dose lubricant for housing o-ring  
CODE RE9020650



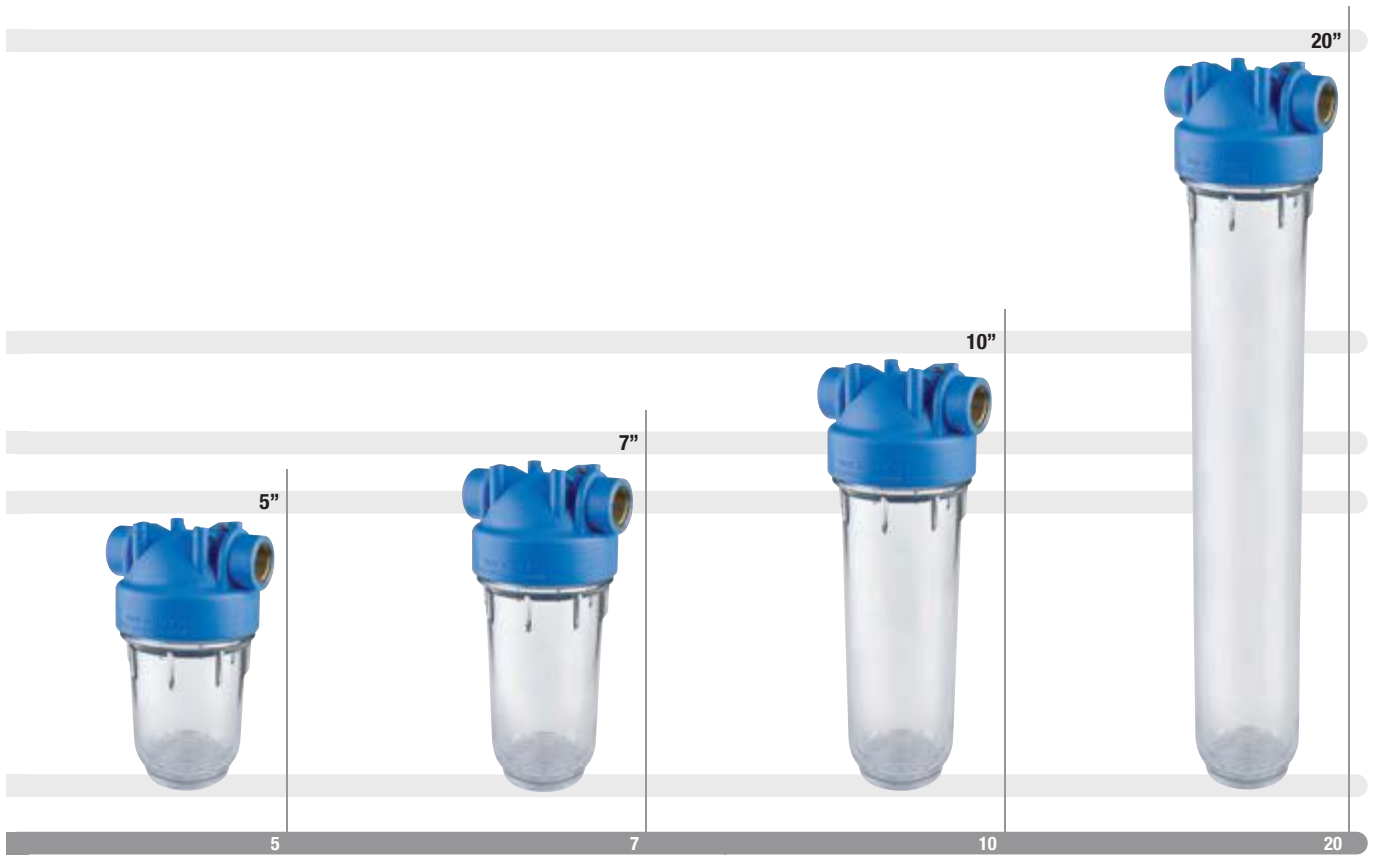

DP	10	MONO	3/4"	OT	TS
HOUSINGS MODEL	HOUSINGS HEIGHT	VERSION	IN / OUT	THREADS TYPE	BOWL TYPE
<p>DP</p>  <p>DP S</p>  <p>DP M</p>  <p>DP S M</p> 	<p>MONO</p>  <p>DUO</p>  <p>TRIO</p> 	<p>1/4"</p> <p>3/8"</p> <p>1/2"</p> <p>3/4"</p> <p>1"</p> <p>1 1/4"</p> <p>1 1/2"</p>	<p>OT - BRASS BSP*</p>  <p>IN - PLASTIC BSP*</p>  <p>MP - PLASTIC BSP *</p>  <p>NPT IN - PLASTIC NPT**</p> 	<p>TS - CLEAR (PET)</p>  <p>AB - BLUE (PET)</p>  <p>BW - WHITE (PET)</p> 	



\* BSP  
parallel (cylindrical)  
ISO 228



\*\* NPT  
tapered (conical)  
ANSI/ASME B1.20.1





# DP MONO

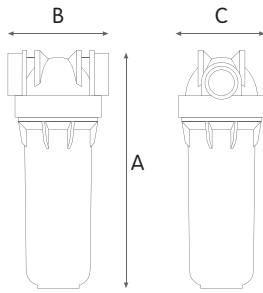

## WORKING CONDITIONS

Max working pressure: \_\_\_\_\_ 8 bar (116 psi)  
 Max working temperature \_\_\_\_\_ 45°C (113°F)  
 Min working temperature \_\_\_\_\_ 4°C (39,2°F)

## SPECIFICATIONS

Non-toxic materials, suitable for drinking water.  
 Head: reinforced polypropylene.  
 Bowl: PET.  
 O-ring: EPDM.  
 Breather-valve: body stainless steel, o-ring EPDM.  
 IN/OUT brass threads: CW 617 N brass.

## DP MONO clear housings

### HOUSINGS WITH BRASS BSP THREADS

CODE	MODEL	SUITABLE CARTRIDGE	IN/OUT	DIMENSIONS mm		
				A	B	C
RA1350301	DP 5 MONO 1/2" OT TS	5"	1/2"	185	122	107
RA1350401	DP 5 MONO 3/4" OT TS	5"	3/4"	185	122	107
RA1350701	DP 5 MONO 1" OT TS	5"	1"	185	122	107
RA1350801	DP 5 MONO 1"1/4 OT TS	5"	1"1/4	220	124	107
RA1350901	DP 5 MONO 1"1/2 OT TS	5"	1"1/2	220	124	107
RA1351301	DP 7 MONO 1/2" OT TS	7"	1/2"	233	122	107
RA1351401	DP 7 MONO 3/4" OT TS	7"	3/4"	233	122	107
RA1351701	DP 7 MONO 1" OT TS	7"	1"	233	122	107
RA1351801	DP 7 MONO 1"1/4 OT TS	7"	1"1/4	266	124	107
RA1351901	DP 7 MONO 1"1/2 OT TS	7"	1"1/2	266	124	107
RA1380301	DP 10 MONO 1/2" OT TS	10"	1/2"	325	122	107
RA1380401	DP 10 MONO 3/4" OT TS	10"	3/4"	325	122	107
RA1380701	DP 10 MONO 1" OT TS	10"	1"	325	122	107
RA1380801	DP 10 MONO 1"1/4 OT TS	10"	1"1/4	343	124	107
RA1380901	DP 10 MONO 1"1/2 OT TS	10"	1"1/2	343	124	107
RA1381301	DP 20 MONO 1/2" OT TS	20"	1/2"	577	122	107
RA1381401	DP 20 MONO 3/4" OT TS	20"	3/4"	577	122	107
RA1381701	DP 20 MONO 1" OT TS	20"	1"	577	122	107
RA1381801	DP 20 MONO 1"1/4 OT TS	20"	1"1/4	595	124	107
RA1381901	DP 20 MONO 1"1/2 OT TS	20"	1"1/2	595	124	107

### HOUSINGS WITH PLASTIC BSP THREADS

CODE	MODEL	SUITABLE CARTRIDGE	IN/OUT	DIMENSIONS mm		
				A	B	C
RA1350101	DP 5 MONO 1/4" IN TS	5"	1/4"	185	122	107
RA1350201	DP 5 MONO 3/8" IN TS	5"	3/8"	185	122	107
RA1350311	DP 5 MONO 1/2" IN TS	5"	1/2"	185	122	107
RA1350411	DP 5 MONO 3/4" IN TS	5"	3/4"	185	122	107
RA1350711	DP 5 MONO 1" IN TS	5"	1"	185	122	107
RA1351101	DP 7 MONO 1/4" IN TS	7"	1/4"	233	122	107
RA1351201	DP 7 MONO 3/8" IN TS	7"	3/8"	233	122	107
RA1351311	DP 7 MONO 1/2" IN TS	7"	1/2"	233	122	107
RA1351411	DP 7 MONO 3/4" IN TS	7"	3/4"	233	122	107
RA1351711	DP 7 MONO 1" IN TS	7"	1"	233	122	107
RA1380101	DP 10 MONO 1/4" IN TS	10"	1/4"	325	122	107
RA1380201	DP 10 MONO 3/8" IN TS	10"	3/8"	325	122	107
RA1380311	DP 10 MONO 1/2" IN TS	10"	1/2"	325	122	107
RA1380411	DP 10 MONO 3/4" IN TS	10"	3/4"	325	122	107
RA1380711	DP 10 MONO 1" IN TS	10"	1"	325	122	107
RA1381311	DP 20 MONO 1/2" IN TS	20"	1/2"	577	122	107
RA1381411	DP 20 MONO 3/4" IN TS	20"	3/4"	577	122	107
RA1381711	DP 20 MONO 1" IN TS	20"	1"	577	122	107

## VARIANTS AVAILABLE ON MINIMUM QUANTITY:

- RT housings suitable for filter cartridges with length 508 mm

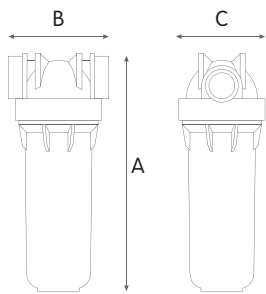

**WORKING CONDITIONS**

Max working pressure:  
 BSP versions \_\_\_\_\_ 8 bar (116 psi)  
 NPT versions \_\_\_\_\_ 8,6 bar (125 psi)  
 Max working temperature \_\_\_\_\_ 45°C (113°F)  
 Min working temperature \_\_\_\_\_ 4°C (39,2°F)

**SPECIFICATIONS**

Non-toxic materials, suitable for drinking water.  
 Head: reinforced polypropylene.  
 Bowl: PET.  
 O-ring: EPDM.  
 Breather-valve: body stainless steel, o-ring EPDM.

**HOUSINGS WITH PLASTIC NPT THREADS**

CODE	MODEL	SUITABLE CARTRIDGE	IN/OUT	DIMENSIONS mm		
				A	B	C
RA1350121	DP 5 MONO 1/4" NPT IN TS	5"	1/4"	185	122	107
RA1350321	DP 5 MONO 1/2" NPT IN TS	5"	1/2"	185	122	107
RA1350421	DP 5 MONO 3/4" NPT IN TS	5"	3/4"	185	122	107
RA1350721	DP 5 MONO 1" NPT IN TS	5"	1"	185	122	107
RA1351121	DP 7 MONO 1/4" NPT IN TS	7"	1/4"	233	122	107
RA1351321	DP 7 MONO 1/2" NPT IN TS	7"	1/2"	233	122	107
RA1351421	DP 7 MONO 3/4" NPT IN TS	7"	3/4"	233	122	107
RA1351721	DP 7 MONO 1" NPT IN TS	7"	1"	233	122	107
RA1380121	DP 10 MONO 1/4" NPT IN TS	10"	1/4"	325	122	107
RA1380321	DP 10 MONO 1/2" NPT IN TS	10"	1/2"	325	122	107
RA1380421	DP 10 MONO 3/4" NPT IN TS	10"	3/4"	325	122	107
RA1380721	DP 10 MONO 1" NPT IN TS	10"	1"	325	122	107
RA1381321	DP 20 MONO 1/2" NPT IN TS	20"	1/2"	577	122	107
RA1381421	DP 20 MONO 3/4" NPT IN TS	20"	3/4"	577	122	107
RA1381721	DP 20 MONO 1" NPT IN TS	20"	1"	577	122	107

**HOUSINGS WITH PLASTIC BSP THREADS**

CODE	MODEL	SUITABLE CARTRIDGE	IN/OUT	DIMENSIONS mm		
				A	B	C
RA1350313	DP 5 MONO 1/2" MP TS	5"	1/2"	185	155	107
RA1350413	DP 5 MONO 3/4" MP TS	5"	3/4"	185	155	107
RA1350713	DP 5 MONO 1" MP TS	5"	1"	185	155	107
RA1351313	DP 7 MONO 1/2" MP TS	7"	1/2"	233	155	107
RA1351413	DP 7 MONO 3/4" MP TS	7"	3/4"	233	155	107
RA1351713	DP 7 MONO 1" MP TS	7"	1"	233	155	107
RA1380213	DP 10 MONO 1/2" MP TS	10"	1/2"	325	155	107
RA1380513	DP 10 MONO 3/4" MP TS	10"	3/4"	325	155	107
RA1380613	DP 10 MONO 1" MP TS	10"	1"	325	155	107
RA1381323	DP 20 MONO 1/2" MP TS	20"	1/2"	577	155	107
RA1381513	DP 20 MONO 3/4" MP TS	20"	3/4"	577	155	107
RA1381613	DP 20 MONO 1" MP TS	20"	1"	577	155	107

**VARIANTS AVAILABLE ON MINIMUM QUANTITY:**

- RT housings suitable for filter cartridges with length 508 mm

Some items in the list are subject to minimum order quantities and/or to longer delivery term.

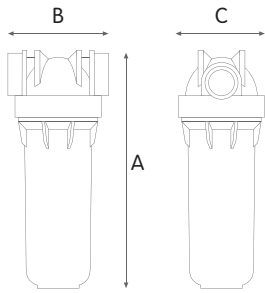

**WORKING CONDITIONS**

Max working pressure: \_\_\_\_\_ 8 bar (116 psi)  
 Max working temperature \_\_\_\_\_ 45°C (113°F)  
 Min working temperature \_\_\_\_\_ 4°C (39,2°F)

**SPECIFICATIONS**

Non-toxic materials, suitable for drinking water.  
 Head: reinforced polypropylene.  
 Bowl: PET.  
 O-ring: EPDM.  
 Breather-valve: body stainless steel, o-ring EPDM.  
 IN/OUT brass threads: CW 617 N brass.

**DP MONO blue housings**

**HOUSINGS WITH BRASS BSP THREADS**

CODE	MODEL	SUITABLE CARTRIDGE	IN/OUT	DIMENSIONS mm		
				A	B	C
RA1350302	DP 5 MONO 1/2" OT AB	5"	1/2"	185	122	107
RA1350402	DP 5 MONO 3/4" OT AB	5"	3/4"	185	122	107
RA1350702	DP 5 MONO 1" OT AB	5"	1"	185	122	107
RA1350802	DP 5 MONO 1"1/4 OT AB	5"	1"1/4	220	124	107
RA1350902	DP 5 MONO 1"1/2 OT AB	5"	1"1/2	220	124	107
RA1351302	DP 7 MONO 1/2" OT AB	7"	1/2"	233	122	107
RA1351402	DP 7 MONO 3/4" OT AB	7"	3/4"	233	122	107
RA1351702	DP 7 MONO 1" OT AB	7"	1"	233	122	107
RA1351802	DP 7 MONO 1"1/4 OT AB	7"	1"1/4	266	124	107
RA1351902	DP 7 MONO 1"1/2 OT AB	7"	1"1/2	266	124	107
RA1380302	DP 10 MONO 1/2" OT AB	10"	1/2"	325	122	107
RA1380402	DP 10 MONO 3/4" OT AB	10"	3/4"	325	122	107
RA1380702	DP 10 MONO 1" OT AB	10"	1"	325	122	107
RA1380802	DP 10 MONO 1"1/4 OT AB	10"	1"1/4	343	124	107
RA1380902	DP 10 MONO 1"1/2 OT AB	10"	1"1/2	343	124	107
RA1381302	DP 20 MONO 1/2" OT AB	20"	1/2"	577	122	107
RA1381402	DP 20 MONO 3/4" OT AB	20"	3/4"	577	122	107
RA1381702	DP 20 MONO 1" OT AB	20"	1"	577	122	107
RA1381802	DP 20 MONO 1"1/4 OT AB	20"	1"1/4	595	124	107
RA1381902	DP 20 MONO 1"1/2 OT AB	20"	1"1/2	595	124	107

**HOUSINGS WITH PLASTIC BSP THREADS**

CODE	MODEL	SUITABLE CARTRIDGE	IN/OUT	DIMENSIONS mm		
				A	B	C
RA1350102	DP 5 MONO 1/4" IN AB	5"	1/4"	185	122	107
RA1350202	DP 5 MONO 3/8" IN AB	5"	3/8"	185	122	107
RA1350312	DP 5 MONO 1/2" IN AB	5"	1/2"	185	122	107
RA1350412	DP 5 MONO 3/4" IN AB	5"	3/4"	185	122	107
RA1350712	DP 5 MONO 1" IN AB	5"	1"	185	122	107
RA1351102	DP 7 MONO 1/4" IN AB	7"	1/4"	233	122	107
RA1351212	DP 7 MONO 3/8" IN AB	7"	3/8"	233	122	107
RA1351312	DP 7 MONO 1/2" IN AB	7"	1/2"	233	122	107
RA1351412	DP 7 MONO 3/4" IN AB	7"	3/4"	233	122	107
RA1351712	DP 7 MONO 1" IN AB	7"	1"	233	122	107
RA1380102	DP 10 MONO 1/4" IN AB	10"	1/4"	325	122	107
RA1380202	DP 10 MONO 3/8" IN AB	10"	3/8"	325	122	107
RA1380312	DP 10 MONO 1/2" IN AB	10"	1/2"	325	122	107
RA1380412	DP 10 MONO 3/4" IN AB	10"	3/4"	325	122	107
RA1380712	DP 10 MONO 1" IN AB	10"	1"	325	122	107
RA1381312	DP 20 MONO 1/2" IN AB	20"	1/2"	577	122	107
RA1381412	DP 20 MONO 3/4" IN AB	20"	3/4"	577	122	107
RA1381712	DP 20 MONO 1" IN AB	20"	1"	577	122	107

**VARIANTS AVAILABLE ON MINIMUM QUANTITY:**

- RT housings suitable for filter cartridges with length 508 mm

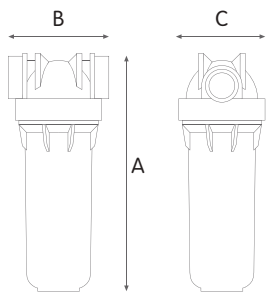

**WORKING CONDITIONS**

Max working pressure:  
 BSP versions \_\_\_\_\_ 8 bar (116 psi)  
 NPT versions \_\_\_\_\_ 8,6 bar (125 psi)  
 Max working temperature \_\_\_\_\_ 45°C (113°F)  
 Min working temperature \_\_\_\_\_ 4°C (39,2°F)

**SPECIFICATIONS**

Non-toxic materials, suitable for drinking water.  
 Head: reinforced polypropylene.  
 Bowl: PET.  
 O-ring: EPDM.  
 Breather-valve: body stainless steel, o-ring EPDM.

**HOUSINGS WITH PLASTIC NPT THREADS**

CODE	MODEL	SUITABLE CARTRIDGE	IN/OUT	DIMENSIONS mm		
				A	B	C
RA1350122	DP 5 MONO 1/4" NPT IN AB	5"	1/4"	185	122	107
RA1350322	DP 5 MONO 1/2" NPT IN AB	5"	1/2"	185	122	107
RA1350422	DP 5 MONO 3/4" NPT IN AB	5"	3/4"	185	122	107
RA1350722	DP 5 MONO 1" NPT IN AB	5"	1"	185	122	107
RA1351122	DP 7 MONO 1/4" NPT IN AB	7"	1/4"	233	122	107
RA1351322	DP 7 MONO 1/2" NPT IN AB	7"	1/2"	233	122	107
RA1351422	DP 7 MONO 3/4" NPT IN AB	7"	3/4"	233	122	107
RA1351722	DP 7 MONO 1" NPT IN AB	7"	1"	233	122	107
RA1380122	DP 10 MONO 1/4" NPT IN AB	10"	1/4"	325	122	107
RA1380322	DP 10 MONO 1/2" NPT IN AB	10"	1/2"	325	122	107
RA1380422	DP 10 MONO 3/4" NPT IN AB	10"	3/4"	325	122	107
RA1380722	DP 10 MONO 1" NPT IN AB	10"	1"	325	122	107
RA1381322	DP 20 MONO 1/2" NPT IN AB	20"	1/2"	577	122	107
RA1381422	DP 20 MONO 3/4" NPT IN AB	20"	3/4"	577	122	107
RA1381722	DP 20 MONO 1" NPT IN AB	20"	1"	577	122	107

**HOUSINGS WITH PLASTIC BSP THREADS**

CODE	MODEL	SUITABLE CARTRIDGE	IN/OUT	DIMENSIONS mm		
				A	B	C
RA1350314	DP 5 MONO 1/2" MP AB	5"	1/2"	185	155	107
RA1350414	DP 5 MONO 3/4" MP AB	5"	3/4"	185	155	107
RA1350714	DP 5 MONO 1" MP AB	5"	1"	185	155	107
RA1351314	DP 7 MONO 1/2" MP AB	7"	1/2"	233	155	107
RA1351414	DP 7 MONO 3/4" MP AB	7"	3/4"	233	155	107
RA1351714	DP 7 MONO 1" MP AB	7"	1"	233	155	107
RA1380214	DP 10 MONO 1/2" MP AB	10"	1/2"	325	155	107
RA1380514	DP 10 MONO 3/4" MP AB	10"	3/4"	325	155	107
RA1380614	DP 10 MONO 1" MP AB	10"	1"	325	155	107
RA1381324	DP 20 MONO 1/2" MP AB	20"	1/2"	577	155	107
RA1381514	DP 20 MONO 3/4" MP AB	20"	3/4"	577	155	107
RA1381614	DP 20 MONO 1" MP AB	20"	1"	577	155	107

**VARIANTS AVAILABLE ON MINIMUM QUANTITY:**

- RT housings suitable for filter cartridges with length 508 mm

Some items in the list are subject to minimum order quantities and/or to longer delivery term.

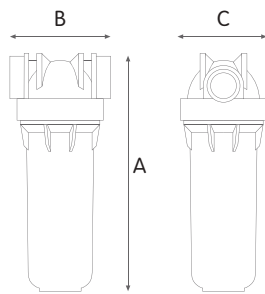

**WORKING CONDITIONS**

Max working pressure: \_\_\_\_\_ 8 bar (116 psi)  
 Max working temperature \_\_\_\_\_ 45°C (113°F)  
 Min working temperature \_\_\_\_\_ 4°C (39,2°F)

**SPECIFICATIONS**

Non-toxic materials, suitable for drinking water.  
 Head: reinforced polypropylene.  
 Bowl: PET.  
 O-ring: EPDM.  
 Breather-valve: body stainless steel, o-ring EPDM.  
 IN/OUT brass threads: CW 617 N brass.

**DP MONO white housings**

**HOUSINGS WITH BRASS BSP THREADS**

CODE	MODEL	SUITABLE CARTRIDGE	IN/OUT	DIMENSIONS mm		
				A	B	C
RA1350306	DP 5 MONO 1/2" OT BW	5"	1/2"	185	122	107
RA1350406	DP 5 MONO 3/4" OT BW	5"	3/4"	185	122	107
RA1350706	DP 5 MONO 1" OT BW	5"	1"	185	122	107
RA1350806	DP 5 MONO 1"1/4 OT BW	5"	1"1/4	220	124	107
RA1350906	DP 5 MONO 1"1/2 OT BW	5"	1"1/2	220	124	107
RA1351306	DP 7 MONO 1/2" OT BW	7"	1/2"	233	122	107
RA1351406	DP 7 MONO 3/4" OT BW	7"	3/4"	233	122	107
RA1351706	DP 7 MONO 1" OT BW	7"	1"	233	122	107
RA1351806	DP 7 MONO 1"1/4 OT BW	7"	1"1/4	266	124	107
RA1351906	DP 7 MONO 1"1/2 OT BW	7"	1"1/2	266	124	107
RA1380306	DP 10 MONO 1/2" OT BW	10"	1/2"	325	122	107
RA1380406	DP 10 MONO 3/4" OT BW	10"	3/4"	325	122	107
RA1380706	DP 10 MONO 1" OT BW	10"	1"	325	122	107
RA1380806	DP 10 MONO 1"1/4 OT BW	10"	1"1/4	343	124	107
RA1380906	DP 10 MONO 1"1/2 OT BW	10"	1"1/2	343	124	107
RA1381306	DP 20 MONO 1/2" OT BW	20"	1/2"	577	122	107
RA1381406	DP 20 MONO 3/4" OT BW	20"	3/4"	577	122	107
RA1381706	DP 20 MONO 1" OT BW	20"	1"	577	122	107
RA1381806	DP 20 MONO 1"1/4 OT BW	20"	1"1/4	595	124	107
RA1381906	DP 20 MONO 1"1/2 OT BW	20"	1"1/2	595	124	107

**HOUSINGS WITH PLASTIC BSP THREADS**

CODE	MODEL	SUITABLE CARTRIDGE	IN/OUT	DIMENSIONS mm		
				A	B	C
RA1350106	DP 5 MONO 1/4" IN BW	5"	1/4"	185	122	107
RA1350206	DP 5 MONO 3/8" IN BW	5"	3/8"	185	122	107
RA1350316	DP 5 MONO 1/2" IN BW	5"	1/2"	185	122	107
RA1350416	DP 5 MONO 3/4" IN BW	5"	3/4"	185	122	107
RA1350716	DP 5 MONO 1" IN BW	5"	1"	185	122	107
RA1351106	DP 7 MONO 1/4" IN BW	7"	1/4"	233	122	107
RA1351206	DP 7 MONO 3/8" IN BW	7"	3/8"	233	122	107
RA1351316	DP 7 MONO 1/2" IN BW	7"	1/2"	233	122	107
RA1351416	DP 7 MONO 3/4" IN BW	7"	3/4"	233	122	107
RA1351716	DP 7 MONO 1" IN BW	7"	1"	233	122	107
RA1380106	DP 10 MONO 1/4" IN BW	10"	1/4"	325	122	107
RA1380206	DP 10 MONO 3/8" IN BW	10"	3/8"	325	122	107
RA1380316	DP 10 MONO 1/2" IN BW	10"	1/2"	325	122	107
RA1380416	DP 10 MONO 3/4" IN BW	10"	3/4"	325	122	107
RA1380716	DP 10 MONO 1" IN BW	10"	1"	325	122	107
RA1381316	DP 20 MONO 1/2" IN BW	20"	1/2"	577	122	107
RA1381416	DP 20 MONO 3/4" IN BW	20"	3/4"	577	122	107
RA1381716	DP 20 MONO 1" IN BW	20"	1"	577	122	107

**VARIANTS AVAILABLE ON MINIMUM QUANTITY:**

- RT housings suitable for filter cartridges with length 508 mm

Some items in the list are subject to minimum order quantities and/or to longer delivery term.

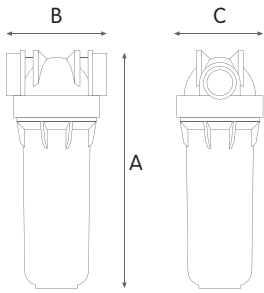

**WORKING CONDITIONS**

Max working pressure:  
 BSP versions \_\_\_\_\_ 8 bar (116 psi)  
 NPT versions \_\_\_\_\_ 8,6 bar (125 psi)  
 Max working temperature \_\_\_\_\_ 45°C (113°F)  
 Min working temperature \_\_\_\_\_ 4°C (39,2°F)

**SPECIFICATIONS**

Non-toxic materials, suitable for drinking water.  
 Head: reinforced polypropylene.  
 Bowl: PET.  
 O-ring: EPDM.  
 Breather-valve: body stainless steel, o-ring EPDM.

**HOUSINGS WITH PLASTIC NPT THREADS**

CODE	MODEL	SUITABLE CARTRIDGE	IN/OUT	DIMENSIONS mm		
				A	B	C
RA1350116	DP 5 MONO 1/4" NPT IN BW	5"	1/4"	185	122	107
RA1350326	DP 5 MONO 1/2" NPT IN BW	5"	1/2"	185	122	107
RA1350426	DP 5 MONO 3/4" NPT IN BW	5"	3/4"	185	122	107
RA1350726	DP 5 MONO 1" NPT IN BW	5"	1"	185	122	107
RA1351126	DP 7 MONO 1/4" NPT IN BW	7"	1/4"	233	122	107
RA1351326	DP 7 MONO 1/2" NPT IN BW	7"	1/2"	233	122	107
RA1351426	DP 7 MONO 3/4" NPT IN BW	7"	3/4"	233	122	107
RA1351726	DP 7 MONO 1" NPT IN BW	7"	1"	233	122	107
RA1380126	DP 10 MONO 1/4" NPT IN BW	10"	1/4"	325	122	107
RA1380326	DP 10 MONO 1/2" NPT IN BW	10"	1/2"	325	122	107
RA1380426	DP 10 MONO 3/4" NPT IN BW	10"	3/4"	325	122	107
RA1380726	DP 10 MONO 1" NPT IN BW	10"	1"	325	122	107
RA1381326	DP 20 MONO 1/2" NPT IN BW	20"	1/2"	577	122	107
RA1381426	DP 20 MONO 3/4" NPT IN BW	20"	3/4"	577	122	107
RA1381726	DP 20 MONO 1" NPT IN BW	20"	1"	577	122	107

**HOUSINGS WITH PLASTIC BSP THREADS**

CODE	MODEL	SUITABLE CARTRIDGE	IN/OUT	DIMENSIONS mm		
				A	B	C
RA1350315	DP 5 MONO 1/2" MP BW	5"	1/2"	185	155	107
RA1350415	DP 5 MONO 3/4" MP BW	5"	3/4"	185	155	107
RA1350715	DP 5 MONO 1" MP BW	5"	1"	185	155	107
RA1351315	DP 7 MONO 1/2" MP BW	7"	1/2"	233	155	107
RA1351415	DP 7 MONO 3/4" MP BW	7"	3/4"	233	155	107
RA1351715	DP 7 MONO 1" MP BW	7"	1"	233	155	107
RA1380215	DP 10 MONO 1/2" MP BW	10"	1/2"	325	155	107
RA1380515	DP 10 MONO 3/4" MP BW	10"	3/4"	325	155	107
RA1380615	DP 10 MONO 1" MP BW	10"	1"	325	155	107
RA1381325	DP 20 MONO 1/2" MP BW	20"	1/2"	577	155	107
RA1381515	DP 20 MONO 3/4" MP BW	20"	3/4"	577	155	107
RA1381615	DP 20 MONO 1" MP BW	20"	1"	577	155	107

**VARIANTS AVAILABLE ON MINIMUM QUANTITY:**

- RT housings suitable for filter cartridges with length 508 mm

Some items in the list are subject to minimum order quantities and/or to longer delivery term.





# DP M MONO

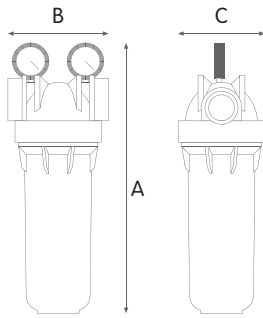

## WORKING CONDITIONS

Max working pressure:  
 BSP versions \_\_\_\_\_ 8 bar (116 psi)  
 NPT versions \_\_\_\_\_ 8,6 bar (125 psi)  
 Max working temperature \_\_\_\_\_ 45°C (113°F)  
 Min working temperature \_\_\_\_\_ 4°C (39,2°F)

## SPECIFICATIONS

Non-toxic materials, suitable for drinking water.  
 Head: reinforced polypropylene.  
 Bowl: PET.  
 O-ring: EPDM.  
 IN/OUT brass threads: CW 617 N brass.  
 Manometers: radial type, pressure range 0-12 bar, 0-170 psi.

## DP M MONO clear housings with 2 manometers

### HOUSINGS WITH BRASS BSP THREADS

CODE	MODEL	SUITABLE CARTRIDGE	IN/OUT	DIMENSIONS mm		
				A	B	C
RA1350331	DP M 5 MONO 1/2" OT TS	5"	1/2"	232	122	107
RA1350431	DP M 5 MONO 3/4" OT TS	5"	3/4"	232	122	107
RA1350731	DP M 5 MONO 1" OT TS	5"	1"	232	122	107
RA1350831	DP M 5 MONO 1"1/4 OT TS	5"	1"1/4	267	124	107
RA1350931	DP M 5 MONO 1"1/2 OT TS	5"	1"1/2	267	124	107
RA1351331	DP M 7 MONO 1/2" OT TS	7"	1/2"	280	122	107
RA1351431	DP M 7 MONO 3/4" OT TS	7"	3/4"	280	122	107
RA1351731	DP M 7 MONO 1" OT TS	7"	1"	280	122	107
RA1351831	DP M 7 MONO 1"1/4 OT TS	7"	1"1/4	313	124	107
RA1351931	DP M 7 MONO 1"1/2 OT TS	7"	1"1/2	313	124	107
RA1380331	DP M 10 MONO 1/2" OT TS	10"	1/2"	372	122	107
RA1380431	DP M 10 MONO 3/4" OT TS	10"	3/4"	372	122	107
RA1380731	DP M 10 MONO 1" OT TS	10"	1"	372	122	107
RA1380831	DP M 10 MONO 1"1/4 OT TS	10"	1"1/4	390	124	107
RA1380931	DP M 10 MONO 1"1/2 OT TS	10"	1"1/2	390	124	107
RA1381331	DP M 20 MONO 1/2" OT TS	20"	1/2"	632	122	107
RA1381431	DP M 20 MONO 3/4" OT TS	20"	3/4"	632	122	107
RA1381731	DP M 20 MONO 1" OT TS	20"	1"	632	122	107
RA1381831	DP M 20 MONO 1"1/4 OT TS	20"	1"1/4	643	124	107
RA1381931	DP M 20 MONO 1"1/2 OT TS	20"	1"1/2	643	124	107

### HOUSINGS WITH PLASTIC BSP THREADS

CODE	MODEL	SUITABLE CARTRIDGE	IN/OUT	DIMENSIONS mm		
				A	B	C
RA1350351	DP M 5 MONO 1/2" IN TS	5"	1/2"	232	122	107
RA1350451	DP M 5 MONO 3/4" IN TS	5"	3/4"	232	122	107
RA1350751	DP M 5 MONO 1" IN TS	5"	1"	232	122	107
RA1351351	DP M 7 MONO 1/2" IN TS	7"	1/2"	280	122	107
RA1351451	DP M 7 MONO 3/4" IN TS	7"	3/4"	280	122	107
RA1351751	DP M 7 MONO 1" IN TS	7"	1"	280	122	107
RA1380351	DP M 10 MONO 1/2" IN TS	10"	1/2"	372	122	107
RA1380451	DP M 10 MONO 3/4" IN TS	10"	3/4"	372	122	107
RA1380751	DP M 10 MONO 1" IN TS	10"	1"	372	122	107
RA1381351	DP M 20 MONO 1/2" IN TS	20"	1/2"	632	122	107
RA1381451	DP M 20 MONO 3/4" IN TS	20"	3/4"	643	122	107
RA1381751	DP M 20 MONO 1" IN TS	20"	1"	643	122	107

### HOUSINGS WITH PLASTIC NPT THREADS

CODE	MODEL	SUITABLE CARTRIDGE	IN/OUT	DIMENSIONS mm		
				A	B	C
RA1350441	DP M 5 MONO 3/4" NPT IN TS	5"	3/4"	232	122	107
RA1350741	DP M 5 MONO 1" NPT IN TS	5"	1"	232	122	107
RA1351441	DP M 7 MONO 3/4" NPT IN TS	7"	3/4"	280	122	107
RA1351741	DP M 7 MONO 1" NPT IN TS	7"	1"	280	122	107
RA1380441	DP M 10 MONO 3/4" NPT IN TS	10"	3/4"	372	122	107
RA1380741	DP M 10 MONO 1" NPT IN TS	10"	1"	372	122	107
RA1381441	DP M 20 MONO 3/4" NPT IN TS	20"	3/4"	643	122	107
RA1381741	DP M 20 MONO 1" NPT IN TS	20"	1"	643	122	107

## VARIANTS AVAILABLE ON MINIMUM QUANTITY:

- RT housings suitable for filter cartridges with length 508 mm

Some items in the list are subject to minimum order quantities and/or to longer delivery term.

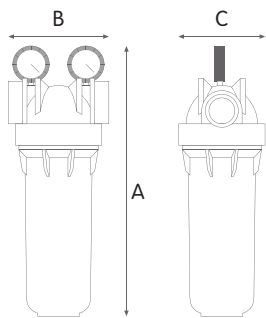

**WORKING CONDITIONS**

Max working pressure:  
 BSP versions \_\_\_\_\_ 8 bar (116 psi)  
 NPT versions \_\_\_\_\_ 8,6 bar (125 psi)  
 Max working temperature \_\_\_\_\_ 45°C (113°F)  
 Min working temperature \_\_\_\_\_ 4°C (39,2°F)

**SPECIFICATIONS**

Non-toxic materials, suitable for drinking water.  
 Head: reinforced polypropylene.  
 Bowl: PET.  
 O-ring: EPDM.  
 IN/OUT brass threads: CW 617 N brass.  
 Manometers: radial type, pressure range 0-12 bar, 0-170 psi.

**DP M MONO blue housings with 2 manometers**

**HOUSINGS WITH BRASS BSP THREADS**

CODE	MODEL	SUITABLE CARTRIDGE	IN/OUT	DIMENSIONS mm		
				A	B	C
RA1350332	DP M 5 MONO 1/2" OT AB	5"	1/2"	232	122	107
RA1350432	DP M 5 MONO 3/4" OT AB	5"	3/4"	232	122	107
RA1350732	DP M 5 MONO 1" OT AB	5"	1"	232	122	107
RA1350832	DP M 5 MONO 1"1/4 OT AB	5"	1"1/4	267	124	107
RA1350932	DP M 5 MONO 1"1/2 OT AB	5"	1"1/2	267	124	107
RA1351332	DP M 7 MONO 1/2" OT AB	7"	1/2"	280	122	107
RA1351432	DP M 7 MONO 3/4" OT AB	7"	3/4"	280	122	107
RA1351732	DP M 7 MONO 1" OT AB	7"	1"	280	122	107
RA1351832	DP M 7 MONO 1"1/4 OT AB	7"	1"1/4	313	124	107
RA1351932	DP M 7 MONO 1"1/2 OT AB	7"	1"1/2	313	124	107
RA1380332	DP M 10 MONO 1/2" OT AB	10"	1/2"	372	122	107
RA1380432	DP M 10 MONO 3/4" OT AB	10"	3/4"	372	122	107
RA1380732	DP M 10 MONO 1" OT AB	10"	1"	372	122	107
RA1380832	DP M 10 MONO 1"1/4 OT AB	10"	1"1/4	390	124	107
RA1380932	DP M 10 MONO 1"1/2 OT AB	10"	1"1/2	390	124	107
RA1381332	DP M 20 MONO 1/2" OT AB	20"	1/2"	632	122	107
RA1381432	DP M 20 MONO 3/4" OT AB	20"	3/4"	632	122	107
RA1381732	DP M 20 MONO 1" OT AB	20"	1"	632	122	107
RA1381832	DP M 20 MONO 1"1/4 OT AB	20"	1"1/4	643	124	107
RA1381932	DP M 20 MONO 1"1/2 OT AB	20"	1"1/2	643	124	107

**HOUSINGS WITH PLASTIC BSP THREADS**

CODE	MODEL	SUITABLE CARTRIDGE	IN/OUT	DIMENSIONS mm		
				A	B	C
RA1350352	DP M 5 MONO 1/2" IN AB	5"	1/2"	232	122	107
RA1350452	DP M 5 MONO 3/4" IN AB	5"	3/4"	232	122	107
RA1350752	DP M 5 MONO 1" IN AB	5"	1"	232	122	107
RA1351352	DP M 7 MONO 1/2" IN AB	7"	1/2"	280	122	107
RA1351452	DP M 7 MONO 3/4" IN AB	7"	3/4"	280	122	107
RA1351752	DP M 7 MONO 1" IN AB	7"	1"	280	122	107
RA1380352	DP M 10 MONO 1/2" IN AB	10"	1/2"	372	122	107
RA1380452	DP M 10 MONO 3/4" IN AB	10"	3/4"	372	122	107
RA1380752	DP M 10 MONO 1" IN AB	10"	1"	372	122	107
RA1381352	DP M 20 MONO 1/2" IN AB	20"	1/2"	632	122	107
RA1381452	DP M 20 MONO 3/4" IN AB	20"	3/4"	643	122	107
RA1381752	DP M 20 MONO 1" IN AB	20"	1"	643	122	107

**HOUSINGS WITH PLASTIC NPT THREADS**

CODE	MODEL	SUITABLE CARTRIDGE	IN/OUT	DIMENSIONS mm		
				A	B	C
RA1350442	DP M 5 MONO 3/4" NPT IN AB	5"	3/4"	232	122	107
RA1350742	DP M 5 MONO 1" NPT IN AB	5"	1"	232	122	107
RA1351442	DP M 7 MONO 3/4" NPT IN AB	7"	3/4"	280	122	107
RA1351742	DP M 7 MONO 1" NPT IN AB	7"	1"	280	122	107
RA1380442	DP M 10 MONO 3/4" NPT IN AB	10"	3/4"	372	122	107
RA1380742	DP M 10 MONO 1" NPT IN AB	10"	1"	372	122	107
RA1381442	DP M 20 MONO 3/4" NPT IN AB	20"	3/4"	643	122	107
RA1381742	DP M 20 MONO 1" NPT IN AB	20"	1"	643	122	107

**VARIANTS AVAILABLE ON MINIMUM QUANTITY:**

- RT housings suitable for filter cartridges with length 508 mm

Some items in the list are subject to minimum order quantities and/or to longer delivery term.

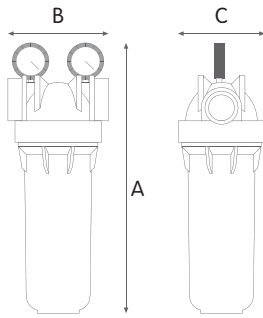

**WORKING CONDITIONS**

Max working pressure:  
 BSP versions \_\_\_\_\_ 8 bar (116 psi)  
 NPT versions \_\_\_\_\_ 8,6 bar (125 psi)  
 Max working temperature \_\_\_\_\_ 45°C (113°F)  
 Min working temperature \_\_\_\_\_ 4°C (39,2°F)

**SPECIFICATIONS**

Non-toxic materials, suitable for drinking water.  
 Head: reinforced polypropylene.  
 Bowl: PET.  
 O-ring: EPDM.  
 IN/OUT brass threads: CW 617 N brass.  
 Manometers: radial type, pressure range 0-12 bar, 0-170 psi.

**DP M MONO white housings with 2 manometers**

**HOUSINGS WITH BRASS BSP THREADS**

CODE	MODEL	SUITABLE CARTRIDGE	IN/OUT	DIMENSIONS mm		
				A	B	C
RA1350336	DP M 5 MONO 1/2" OT BW	5"	1/2"	232	122	107
RA1350436	DP M 5 MONO 3/4" OT BW	5"	3/4"	232	122	107
RA1350736	DP M 5 MONO 1" OT BW	5"	1"	232	122	107
RA1350836	DP M 5 MONO 1"1/4 OT BW	5"	1"1/4	267	124	107
RA1350936	DP M 5 MONO 1"1/2 OT BW	5"	1"1/2	267	124	107
RA1351336	DP M 7 MONO 1/2" OT BW	7"	1/2"	280	122	107
RA1351436	DP M 7 MONO 3/4" OT BW	7"	3/4"	280	122	107
RA1351736	DP M 7 MONO 1" OT BW	7"	1"	280	122	107
RA1351836	DP M 7 MONO 1"1/4 OT BW	7"	1"1/4	313	124	107
RA1351936	DP M 7 MONO 1"1/2 OT BW	7"	1"1/2	313	124	107
RA1380336	DP M 10 MONO 1/2" OT BW	10"	1/2"	372	122	107
RA1380436	DP M 10 MONO 3/4" OT BW	10"	3/4"	372	122	107
RA1380736	DP M 10 MONO 1" OT BW	10"	1"	372	122	107
RA1380836	DP M 10 MONO 1"1/4 OT BW	10"	1"1/4	390	124	107
RA1380936	DP M 10 MONO 1"1/2 OT BW	10"	1"1/2	390	124	107
RA1381336	DP M 20 MONO 1/2" OT BW	20"	1/2"	632	122	107
RA1381436	DP M 20 MONO 3/4" OT BW	20"	3/4"	632	122	107
RA1381736	DP M 20 MONO 1" OT BW	20"	1"	632	122	107
RA1381836	DP M 20 MONO 1"1/4 OT BW	20"	1"1/4	643	124	107
RA1381936	DP M 20 MONO 1"1/2 OT BW	20"	1"1/2	643	124	107

**HOUSINGS WITH PLASTIC BSP THREADS**

CODE	MODEL	SUITABLE CARTRIDGE	IN/OUT	DIMENSIONS mm		
				A	B	C
RA1350356	DP M 5 MONO 1/2" IN BW	5"	1/2"	232	122	107
RA1350456	DP M 5 MONO 3/4" IN BW	5"	3/4"	232	122	107
RA1350756	DP M 5 MONO 1" IN BW	5"	1"	232	122	107
RA1351356	DP M 7 MONO 1/2" IN BW	7"	1/2"	280	122	107
RA1351456	DP M 7 MONO 3/4" IN BW	7"	3/4"	280	122	107
RA1351756	DP M 7 MONO 1" IN BW	7"	1"	280	122	107
RA1380356	DP M 10 MONO 1/2" IN BW	10"	1/2"	372	122	107
RA1380456	DP M 10 MONO 3/4" IN BW	10"	3/4"	372	122	107
RA1380756	DP M 10 MONO 1" IN BW	10"	1"	372	122	107
RA1381356	DP M 20 MONO 1/2" IN BW	20"	1/2"	632	122	107
RA1381456	DP M 20 MONO 3/4" IN BW	20"	3/4"	643	122	107
RA1381756	DP M 20 MONO 1" IN BW	20"	1"	643	122	107

**HOUSINGS WITH PLASTIC NPT THREADS**

CODE	MODEL	SUITABLE CARTRIDGE	IN/OUT	DIMENSIONS mm		
				A	B	C
RA1350446	DP M 5 MONO 3/4" NPT IN BW	5"	3/4"	232	122	107
RA1350746	DP M 5 MONO 1" NPT IN BW	5"	1"	232	122	107
RA1351446	DP M 7 MONO 3/4" NPT IN BW	7"	3/4"	280	122	107
RA1351746	DP M 7 MONO 1" NPT IN BW	7"	1"	280	122	107
RA1380446	DP M 10 MONO 3/4" NPT IN BW	10"	3/4"	372	122	107
RA1380746	DP M 10 MONO 1" NPT IN BW	10"	1"	372	122	107
RA1381446	DP M 20 MONO 3/4" NPT IN BW	20"	3/4"	643	122	107
RA1381746	DP M 20 MONO 1" NPT IN BW	20"	1"	643	122	107

**VARIANTS AVAILABLE ON MINIMUM QUANTITY:**

- RT housings suitable for filter cartridges with length 508 mm

Some items in the list are subject to minimum order quantities and/or to longer delivery term.



# DP S MONO only for BX cartridges

## WORKING CONDITIONS

Max working pressure:  
 BSP versions \_\_\_\_\_ 8 bar (116 psi)  
 NPT versions \_\_\_\_\_ 8,6 bar (125 psi)  
 Max working temperature \_\_\_\_\_ 45°C (113°F)  
 Min working temperature \_\_\_\_\_ 4°C (39,2°F)

## SPECIFICATIONS

Non-toxic materials, suitable for drinking water.  
 Head: reinforced polypropylene.  
 Bowl: PET.  
 O-ring: EPDM.  
 Breather-valve: body stainless steel, o-ring EPDM.  
 IN/OUT brass threads: CW 617 N brass.  
 Discharge ball-valve: CW 617 N brass nickel plated.  
 Discharge plastic nipple: reinforced polypropylene.  
 Drain funnel: reinforced polypropylene.

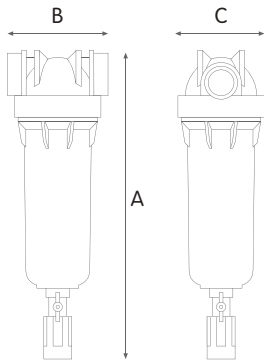

**DRAIN FUNNEL**  
 Back-flow preventing device  
 UNI EN 1717-11/2002

DP FILTER HOUSINGS

## DP S MONO clear housings with discharge valve

### HOUSINGS WITH BRASS BSP THREADS

CODE	MODEL	SUITABLE CARTRIDGE	IN/OUT	DIMENSIONS mm		
				A	B	C
RA1380303	DP S 10 MONO 1/2" OT TS	10"	1/2"	465	122	107
RA1380403	DP S 10 MONO 3/4" OT TS	10"	3/4"	465	122	107
RA1380703	DP S 10 MONO 1" OT TS	10"	1"	465	122	107
RA1380803	DP S 10 MONO 1"1/4 OT TS	10"	1"1/4	493	124	107
RA1380903	DP S 10 MONO 1"1/2 OT TS	10"	1"1/2	493	124	107
RA1381303	DP S 20 MONO 1/2" OT TS	20"	1/2"	723	122	107
RA1381403	DP S 20 MONO 3/4" OT TS	20"	3/4"	723	122	107
RA1381703	DP S 20 MONO 1" OT TS	20"	1"	723	122	107
RA1381803	DP S 20 MONO 1"1/4 OT TS	20"	1"1/4	740	122	107
RA1381903	DP S 20 MONO 1"1/2 OT TS	20"	1"1/2	740	124	107

### HOUSINGS WITH PLASTIC BSP THREADS

CODE	MODEL	SUITABLE CARTRIDGE	IN/OUT	DIMENSIONS mm		
				A	B	C
RA1380313	DP S 10 MONO 1/2" IN TS	10"	1/2"	465	122	107
RA1380413	DP S 10 MONO 3/4" IN TS	10"	3/4"	465	122	107
RA1380713	DP S 10 MONO 1" IN TS	10"	1"	465	122	107
RA1381313	DP S 20 MONO 1/2" IN TS	20"	1/2"	723	122	107
RA1381413	DP S 20 MONO 3/4" IN TS	20"	3/4"	723	122	107
RA1381713	DP S 20 MONO 1" IN TS	20"	1"	723	122	107

### HOUSINGS WITH PLASTIC NPT THREADS

CODE	MODEL	SUITABLE CARTRIDGE	IN/OUT	DIMENSIONS mm		
				A	B	C
RA1380323	DP S 10 MONO 1/2" NPT IN TS	10"	1/2"	465	122	107
RA1380423	DP S 10 MONO 3/4" NPT IN TS	10"	3/4"	465	122	107
RA1380723	DP S 10 MONO 1" NPT IN TS	10"	1"	465	122	107
RA1381343	DP S 20 MONO 1/2" NPT IN TS	20"	1/2"	723	122	107
RA1381423	DP S 20 MONO 3/4" NPT IN TS	20"	3/4"	723	122	107
RA1381723	DP S 20 MONO 1" NPT IN TS	20"	1"	723	122	107

### HOUSINGS WITH PLASTIC BSP THREADS

CODE	MODEL	SUITABLE CARTRIDGE	IN/OUT	DIMENSIONS mm		
				A	B	C
RA1380310	DP S 10 MONO 1/2" MP TS	10"	1/2"	465	155	107
RA1380410	DP S 10 MONO 3/4" MP TS	10"	3/4"	465	155	107
RA1380710	DP S 10 MONO 1" MP TS	10"	1"	465	155	107
RA1381310	DP S 20 MONO 1/2" MP TS	20"	1/2"	723	155	107
RA1381410	DP S 20 MONO 3/4" MP TS	20"	3/4"	723	155	107
RA1381710	DP S 20 MONO 1" MP TS	20"	1"	723	155	107





# DP S M MONO only for BX cartridges

## WORKING CONDITIONS

Max working pressure:  
 BSP versions \_\_\_\_\_ 8 bar (116 psi)  
 NPT versions \_\_\_\_\_ 8,6 bar (125 psi)  
 Max working temperature \_\_\_\_\_ 45°C (113°F)  
 Min working temperature \_\_\_\_\_ 4°C (39,2°F)

## SPECIFICATIONS

Non-toxic materials, suitable for drinking water.  
 Head: reinforced polypropylene.  
 Bowl: PET.  
 O-ring: EPDM.  
 IN/OUT brass threads: CW 617 N brass.  
 Manometers: radial type, pressure range 0-12 bar, 0-170 psi.  
 Discharge ball-valve: CW 617 N brass nickel plated.  
 Discharge plastic nipple: reinforced polypropylene.  
 Drain funnel: reinforced polypropylene.

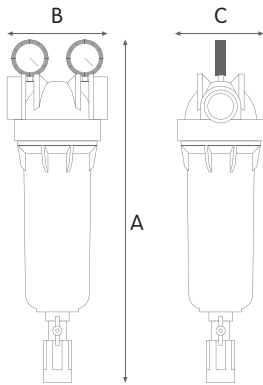

**DRAIN FUNNEL**  
 Back-flow preventing device  
 UNI EN 1717-11/2002

## DP S M MONO clear housings with discharge valve and 2 manometers

### HOUSINGS WITH BRASS BSP THREADS

CODE	MODEL	SUITABLE CARTRIDGE	IN/OUT	DIMENSIONS mm		
				A	B	C
RA1380334	DP S M 10 MONO 1/2" OT TS	10"	1/2"	522	122	107
RA1380434	DP S M 10 MONO 3/4" OT TS	10"	3/4"	522	122	107
RA1380734	DP S M 10 MONO 1" OT TS	10"	1"	522	122	107
RA1380834	DP S M 10 MONO 1"1/4 OT TS	10"	1"1/4	540	124	107
RA1380934	DP S M 10 MONO 1"1/2 OT TS	10"	1"1/2	540	124	107
RA1381334	DP S M 20 MONO 1/2" OT TS	20"	1/2"	776	122	107
RA1381434	DP S M 20 MONO 3/4" OT TS	20"	3/4"	776	122	107
RA1381734	DP S M 20 MONO 1" OT TS	20"	1"	776	122	107
RA1381834	DP S M 20 MONO 1"1/4 OT TS	20"	1"1/4	787	124	107
RA1381934	DP S M 20 MONO 1"1/2 OT TS	20"	1"1/2	787	124	107



### HOUSINGS WITH PLASTIC BSP THREADS

CODE	MODEL	SUITABLE CARTRIDGE	IN/OUT	DIMENSIONS mm		
				A	B	C
RA1380354	DP S M 10 MONO 1/2" IN TS	10"	1/2"	522	122	107
RA1380454	DP S M 10 MONO 3/4" IN TS	10"	3/4"	522	122	107
RA1380754	DP S M 10 MONO 1" IN TS	10"	1"	522	122	107
RA1381354	DP S M 20 MONO 1/2" IN TS	20"	1/2"	776	122	107
RA1381454	DP S M 20 MONO 3/4" IN TS	20"	3/4"	776	122	107
RA1381754	DP S M 20 MONO 1" IN TS	20"	1"	776	122	107



### HOUSINGS WITH PLASTIC NPT THREADS

CODE	MODEL	SUITABLE CARTRIDGE	IN/OUT	DIMENSIONS mm		
				A	B	C
RA1380444	DP S M 10 MONO 3/4" NPT IN TS	10"	3/4"	522	122	107
RA1380744	DP S M 10 MONO 1" NPT IN TS	10"	1"	522	122	107
RA1381444	DP S M 20 MONO 3/4" NPT IN TS	20"	3/4"	776	122	107
RA1381744	DP S M 20 MONO 1" NPT IN TS	20"	1"	776	122	107

Some items in the list are subject to minimum order quantities and/or to longer delivery term.



# DP DUO

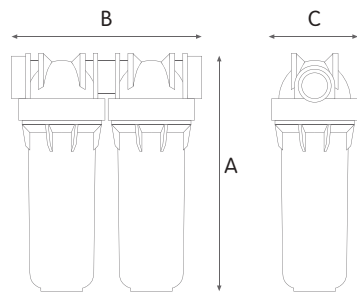

## WORKING CONDITIONS

Max working pressure:  
 BSP versions \_\_\_\_\_ 8 bar (116 psi)  
 NPT versions \_\_\_\_\_ 8,6 bar (125 psi)  
 Max working temperature \_\_\_\_\_ 45°C (113°F)  
 Min working temperature \_\_\_\_\_ 4°C (39,2°F)

## SPECIFICATIONS

Non-toxic materials, suitable for drinking water.  
 Head: reinforced polypropylene.  
 Bowls: PET.  
 O-rings: EPDM.  
 Breather-valve: body stainless steel, o-ring EPDM.  
 IN/OUT brass threads: CW 617 N brass.

## DP DUO clear housings

### HOUSINGS WITH BRASS BSP THREADS

CODE	MODEL	SUITABLE CARTRIDGE	IN/OUT	DIMENSIONS mm		
				A	B	C
RA1360301	DP 5 DUO 1/2" OT TS	5"	1/2"	185	228	107
RA1360401	DP 5 DUO 3/4" OT TS	5"	3/4"	185	228	107
RA1360701	DP 5 DUO 1" OT TS	5"	1"	185	228	107
RA1361301	DP 7 DUO 1/2" OT TS	7"	1/2"	233	228	107
RA1361401	DP 7 DUO 3/4" OT TS	7"	3/4"	233	228	107
RA1361701	DP 7 DUO 1" OT TS	7"	1"	233	228	107
RA1390301	DP 10 DUO 1/2" OT TS	10"	1/2"	325	228	107
RA1390401	DP 10 DUO 3/4" OT TS	10"	3/4"	325	228	107
RA1390701	DP 10 DUO 1" OT TS	10"	1"	325	228	107
RA1391301	DP 20 DUO 1/2" OT TS	20"	1/2"	577	228	107
RA1391401	DP 20 DUO 3/4" OT TS	20"	3/4"	577	228	107
RA1391701	DP 20 DUO 1" OT TS	20"	1"	577	228	107

### HOUSINGS WITH PLASTIC BSP THREADS

CODE	MODEL	SUITABLE CARTRIDGE	IN/OUT	DIMENSIONS mm		
				A	B	C
RA1360101	DP 5 DUO 1/4" IN TS	5"	1/4"	185	228	107
RA1360311	DP 5 DUO 1/2" IN TS	5"	1/2"	185	228	107
RA1360411	DP 5 DUO 3/4" IN TS	5"	3/4"	185	228	107
RA1360711	DP 5 DUO 1" IN TS	5"	1"	185	228	107
RA1361101	DP 7 DUO 1/4" IN TS	7"	1/4"	233	228	107
RA1361311	DP 7 DUO 1/2" IN TS	7"	1/2"	233	228	107
RA1361411	DP 7 DUO 3/4" IN TS	7"	3/4"	233	228	107
RA1361711	DP 7 DUO 1" IN TS	7"	1"	233	228	107
RA1390101	DP 10 DUO 1/4" IN TS	10"	1/4"	325	228	107
RA1390311	DP 10 DUO 1/2" IN TS	10"	1/2"	325	228	107
RA1390411	DP 10 DUO 3/4" IN TS	10"	3/4"	325	228	107
RA1390711	DP 10 DUO 1" IN TS	10"	1"	325	228	107
RA1391311	DP 20 DUO 1/2" IN TS	20"	1/2"	577	228	107
RA1391411	DP 20 DUO 3/4" IN TS	20"	3/4"	577	228	107
RA1391711	DP 20 DUO 1" IN TS	20"	1"	577	228	107

### HOUSINGS WITH PLASTIC NPT THREADS

CODE	MODEL	SUITABLE CARTRIDGE	IN/OUT	DIMENSIONS mm		
				A	B	C
RA1360121	DP 5 DUO 1/4" NPT IN TS	5"	1/4"	185	228	107
RA1360421	DP 5 DUO 3/4" NPT IN TS	5"	3/4"	185	228	107
RA1360721	DP 5 DUO 1" NPT IN TS	5"	1"	185	228	107
RA1361121	DP 7 DUO 1/4" NPT IN TS	7"	1/4"	233	228	107
RA1361421	DP 7 DUO 3/4" NPT IN TS	7"	3/4"	233	228	107
RA1361721	DP 7 DUO 1" NPT IN TS	7"	1"	233	228	107
RA1390121	DP 10 DUO 1/4" NPT IN TS	10"	1/4"	325	228	107
RA1390421	DP 10 DUO 3/4" NPT IN TS	10"	3/4"	325	228	107
RA1390721	DP 10 DUO 1" NPT IN TS	10"	1"	325	228	107
RA1391421	DP 20 DUO 3/4" NPT IN TS	20"	3/4"	577	228	107
RA1391721	DP 20 DUO 1" NPT IN TS	20"	1"	577	228	107

## VARIANTS AVAILABLE ON MINIMUM QUANTITY:

- RT housings suitable for filter cartridges with length 508 mm

Some items in the list are subject to minimum order quantities and/or to longer delivery term.



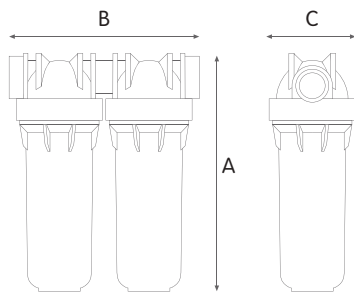

**WORKING CONDITIONS**

Max working pressure:  
 BSP versions \_\_\_\_\_ 8 bar (116 psi)  
 NPT versions \_\_\_\_\_ 8,6 bar (125 psi)  
 Max working temperature \_\_\_\_\_ 45°C (113°F)  
 Min working temperature \_\_\_\_\_ 4°C (39,2°F)

**SPECIFICATIONS**

Non-toxic materials, suitable for drinking water.  
 Head: reinforced polypropylene.  
 Bowls: PET.  
 O-rings: EPDM.  
 Breather-valve: body stainless steel, o-ring EPDM.  
 IN/OUT brass threads: CW 617 N brass.

**DP DUO blue housings**

**HOUSINGS WITH BRASS BSP THREADS**

CODE	MODEL	SUITABLE CARTRIDGE	IN/OUT	DIMENSIONS mm		
				A	B	C
RA1360302	DP 5 DUO 1/2" OT AB	5"	1/2"	185	228	107
RA1360402	DP 5 DUO 3/4" OT AB	5"	3/4"	185	228	107
RA1360702	DP 5 DUO 1" OT AB	5"	1"	185	228	107
RA1361302	DP 7 DUO 1/2" OT AB	7"	1/2"	233	228	107
RA1361402	DP 7 DUO 3/4" OT AB	7"	3/4"	233	228	107
RA1361702	DP 7 DUO 1" OT AB	7"	1"	233	228	107
RA1390302	DP 10 DUO 1/2" OT AB	10"	1/2"	325	228	107
RA1390402	DP 10 DUO 3/4" OT AB	10"	3/4"	325	228	107
RA1390702	DP 10 DUO 1" OT AB	10"	1"	325	228	107
RA1391302	DP 20 DUO 1/2" OT AB	20"	1/2"	577	228	107
RA1391402	DP 20 DUO 3/4" OT AB	20"	3/4"	577	228	107
RA1391702	DP 20 DUO 1" OT AB	20"	1"	577	228	107

**HOUSINGS WITH PLASTIC BSP THREADS**

CODE	MODEL	SUITABLE CARTRIDGE	IN/OUT	DIMENSIONS mm		
				A	B	C
RA1360102	DP 5 DUO 1/4" IN AB	5"	1/4"	185	228	107
RA1360312	DP 5 DUO 1/2" IN AB	5"	1/2"	185	228	107
RA1360412	DP 5 DUO 3/4" IN AB	5"	3/4"	185	228	107
RA1360712	DP 5 DUO 1" IN AB	5"	1"	185	228	107
RA1361112	DP 7 DUO 1/4" IN AB	7"	1/4"	233	228	107
RA1361312	DP 7 DUO 1/2" IN AB	7"	1/2"	233	228	107
RA1361412	DP 7 DUO 3/4" IN AB	7"	3/4"	233	228	107
RA1361712	DP 7 DUO 1" IN AB	7"	1"	233	228	107
RA1390102	DP 10 DUO 1/4" IN AB	10"	1/4"	325	228	107
RA1390312	DP 10 DUO 1/2" IN AB	10"	1/2"	325	228	107
RA1390412	DP 10 DUO 3/4" IN AB	10"	3/4"	325	228	107
RA1390712	DP 10 DUO 1" IN AB	10"	1"	325	228	107
RA1391312	DP 20 DUO 1/2" IN AB	20"	1/2"	577	228	107
RA1391412	DP 20 DUO 3/4" IN AB	20"	3/4"	577	228	107
RA1391712	DP 20 DUO 1" IN AB	20"	1"	577	228	107

**HOUSINGS WITH PLASTIC NPT THREADS**

CODE	MODEL	SUITABLE CARTRIDGE	IN/OUT	DIMENSIONS mm		
				A	B	C
RA1360122	DP 5 DUO 1/4" NPT IN AB	5"	1/4"	185	228	107
RA1360422	DP 5 DUO 3/4" NPT IN AB	5"	3/4"	185	228	107
RA1360722	DP 5 DUO 1" NPT IN AB	5"	1"	185	228	107
RA1361122	DP 7 DUO 1/4" NPT IN AB	7"	1/4"	233	228	107
RA1361422	DP 7 DUO 3/4" NPT IN AB	7"	3/4"	233	228	107
RA1361722	DP 7 DUO 1" NPT IN AB	7"	1"	233	228	107
RA1390122	DP 10 DUO 1/4" NPT IN AB	10"	1/4"	325	228	107
RA1390422	DP 10 DUO 3/4" NPT IN AB	10"	3/4"	325	228	107
RA1390722	DP 10 DUO 1" NPT IN AB	10"	1"	325	228	107
RA1391422	DP 20 DUO 3/4" NPT IN AB	20"	3/4"	577	228	107
RA1391722	DP 20 DUO 1" NPT IN AB	20"	1"	577	228	107

**VARIANTS AVAILABLE ON MINIMUM QUANTITY:**

- RT housings suitable for filter cartridges with length 508 mm

Some items in the list are subject to minimum order quantities and/or to longer delivery term.

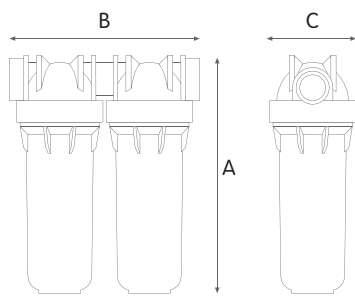

**WORKING CONDITIONS**

Max working pressure:  
 BSP versions \_\_\_\_\_ 8 bar (116 psi)  
 NPT versions \_\_\_\_\_ 8,6 bar (125 psi)  
 Max working temperature \_\_\_\_\_ 45°C (113°F)  
 Min working temperature \_\_\_\_\_ 4°C (39,2°F)

**SPECIFICATIONS**

Non-toxic materials, suitable for drinking water.  
 Head: reinforced polypropylene.  
 Bowls: PET.  
 O-rings: EPDM.  
 Breather-valve: body stainless steel, o-ring EPDM.  
 IN/OUT brass threads: CW 617 N brass.

**DP DUO white housings**

**HOUSINGS WITH BRASS BSP THREADS**

CODE	MODEL	SUITABLE CARTRIDGE	IN/OUT	DIMENSIONS mm		
				A	B	C
RA1360306	DP 5 DUO 1/2" OT BW	5"	1/2"	185	228	107
RA1360406	DP 5 DUO 3/4" OT BW	5"	3/4"	185	228	107
RA1360706	DP 5 DUO 1" OT BW	5"	1"	185	228	107
RA1361306	DP 7 DUO 1/2" OT BW	7"	1/2"	233	228	107
RA1361406	DP 7 DUO 3/4" OT BW	7"	3/4"	233	228	107
RA1361706	DP 7 DUO 1" OT BW	7"	1"	233	228	107
RA1390306	DP 10 DUO 1/2" OT BW	10"	1/2"	325	228	107
RA1390406	DP 10 DUO 3/4" OT BW	10"	3/4"	325	228	107
RA1390706	DP 10 DUO 1" OT BW	10"	1"	325	228	107
RA1391306	DP 20 DUO 1/2" OT BW	20"	1/2"	577	228	107
RA1391406	DP 20 DUO 3/4" OT BW	20"	3/4"	577	228	107
RA1391706	DP 20 DUO 1" OT BW	20"	1"	577	228	107

**HOUSINGS WITH PLASTIC BSP THREADS**

CODE	MODEL	SUITABLE CARTRIDGE	IN/OUT	DIMENSIONS mm		
				A	B	C
RA1360106	DP 5 DUO 1/4" IN BW	5"	1/4"	185	228	107
RA1360316	DP 5 DUO 1/2" IN BW	5"	1/2"	185	228	107
RA1360416	DP 5 DUO 3/4" IN BW	5"	3/4"	185	228	107
RA1360716	DP 5 DUO 1" IN BW	5"	1"	185	228	107
RA1361116	DP 7 DUO 1/4" IN BW	7"	1/4"	233	228	107
RA1361316	DP 7 DUO 1/2" IN BW	7"	1/2"	233	228	107
RA1361416	DP 7 DUO 3/4" IN BW	7"	3/4"	233	228	107
RA1361716	DP 7 DUO 1" IN BW	7"	1"	233	228	107
RA1390106	DP 10 DUO 1/4" IN BW	10"	1/4"	325	228	107
RA1390316	DP 10 DUO 1/2" IN BW	10"	1/2"	325	228	107
RA1390416	DP 10 DUO 3/4" IN BW	10"	3/4"	325	228	107
RA1390716	DP 10 DUO 1" IN BW	10"	1"	325	228	107
RA1391316	DP 20 DUO 1/2" IN BW	20"	1/2"	577	228	107
RA1391416	DP 20 DUO 3/4" IN BW	20"	3/4"	577	228	107
RA1391716	DP 20 DUO 1" IN BW	20"	1"	577	228	107

**HOUSINGS WITH PLASTIC NPT THREADS**

CODE	MODEL	SUITABLE CARTRIDGE	IN/OUT	DIMENSIONS mm		
				A	B	C
RA1360126	DP 5 DUO 1/4" NPT IN BW	5"	1/4"	185	228	107
RA1360426	DP 5 DUO 3/4" NPT IN BW	5"	3/4"	185	228	107
RA1360726	DP 5 DUO 1" NPT IN BW	5"	1"	185	228	107
RA1361126	DP 7 DUO 1/4" NPT IN BW	7"	1/4"	233	228	107
RA1361426	DP 7 DUO 3/4" NPT IN BW	7"	3/4"	233	228	107
RA1361726	DP 7 DUO 1" NPT IN BW	7"	1"	233	228	107
RA1390126	DP 10 DUO 1/4" NPT IN BW	10"	1/4"	325	228	107
RA1390426	DP 10 DUO 3/4" NPT IN BW	10"	3/4"	325	228	107
RA1390726	DP 10 DUO 1" NPT IN BW	10"	1"	325	228	107
RA1391426	DP 20 DUO 3/4" NPT IN BW	20"	3/4"	577	228	107
RA1391726	DP 20 DUO 1" NPT IN BW	20"	1"	577	228	107

**VARIANTS AVAILABLE ON MINIMUM QUANTITY:**

- RT housings suitable for filter cartridges with length 508 mm

Some items in the list are subject to minimum order quantities and/or to longer delivery term.



# DP TRIO

## WORKING CONDITIONS

Max working pressure:  
 BSP versions \_\_\_\_\_ 8 bar (116 psi)  
 NPT versions \_\_\_\_\_ 8,6 bar (125 psi)  
 Max working temperature \_\_\_\_\_ 45°C (113°F)  
 Min working temperature \_\_\_\_\_ 4°C (39,2°F)

## SPECIFICATIONS

Non-toxic materials, suitable for drinking water.  
 Head: reinforced polypropylene.  
 Bowls: PET.  
 O-rings: EPDM.  
 Breather-valve: body stainless steel, o-ring EPDM.  
 IN/OUT brass threads: CW 617 N brass.

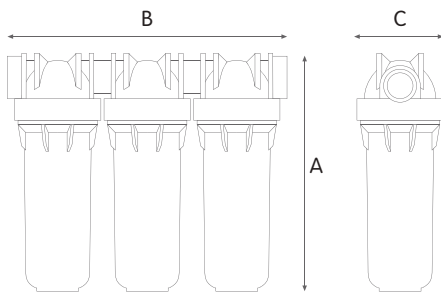

## DP TRIO clear housings

### HOUSINGS WITH BRASS BSP THREADS

CODE	MODEL	SUITABLE CARTRIDGE	IN/OUT	DIMENSIONS mm		
				A	B	C
RA1370301	DP 5 TRIO 1/2" OT TS	5"	1/2"	185	336	107
RA1370401	DP 5 TRIO 3/4" OT TS	5"	3/4"	185	336	107
RA1370701	DP 5 TRIO 1" OT TS	5"	1"	185	336	107
RA1371301	DP 7 TRIO 1/2" OT TS	7"	1/2"	233	336	107
RA1371401	DP 7 TRIO 3/4" OT TS	7"	3/4"	233	336	107
RA1371701	DP 7 TRIO 1" OT TS	7"	1"	233	336	107
RA1400301	DP 10 TRIO 1/2" OT TS	10"	1/2"	325	336	107
RA1400401	DP 10 TRIO 3/4" OT TS	10"	3/4"	325	336	107
RA1400701	DP 10 TRIO 1" OT TS	10"	1"	325	336	107
RA1401301	DP 20 TRIO 1/2" OT TS	20"	1/2"	577	336	107
RA1401401	DP 20 TRIO 3/4" OT TS	20"	3/4"	577	336	107
RA1401701	DP 20 TRIO 1" OT TS	20"	1"	577	336	107

### HOUSINGS WITH PLASTIC BSP THREADS

CODE	MODEL	SUITABLE CARTRIDGE	IN/OUT	DIMENSIONS mm		
				A	B	C
RA1370101	DP 5 TRIO 1/4" IN TS	5"	1/4"	185	336	107
RA1370311	DP 5 TRIO 1/2" IN TS	5"	1/2"	185	336	107
RA1370411	DP 5 TRIO 3/4" IN TS	5"	3/4"	185	336	107
RA1370711	DP 5 TRIO 1" IN TS	5"	1"	185	336	107
RA1371101	DP 7 TRIO 1/4" IN TS	7"	1/4"	233	336	107
RA1371311	DP 7 TRIO 1/2" IN TS	7"	1/2"	233	336	107
RA1371411	DP 7 TRIO 3/4" IN TS	7"	3/4"	233	336	107
RA1371711	DP 7 TRIO 1" IN TS	7"	1"	233	336	107
RA1400101	DP 10 TRIO 1/4" IN TS	10"	1/4"	325	336	107
RA1400311	DP 10 TRIO 1/2" IN TS	10"	1/2"	325	336	107
RA1400411	DP 10 TRIO 3/4" IN TS	10"	3/4"	325	336	107
RA1400711	DP 10 TRIO 1" IN TS	10"	1"	325	336	107
RA1401311	DP 20 TRIO 1/2" IN TS	20"	1/2"	577	336	107
RA1401411	DP 20 TRIO 3/4" IN TS	20"	3/4"	577	336	107
RA1401711	DP 20 TRIO 1" IN TS	20"	1"	577	336	107

### HOUSINGS WITH PLASTIC NPT THREADS

CODE	MODEL	SUITABLE CARTRIDGE	IN/OUT	DIMENSIONS mm		
				A	B	C
RA1370121	DP 5 TRIO 1/4" NPT IN TS	5"	1/4"	185	336	107
RA1370421	DP 5 TRIO 3/4" NPT IN TS	5"	3/4"	185	336	107
RA1370721	DP 5 TRIO 1" NPT IN TS	5"	1"	185	336	107
RA1371121	DP 7 TRIO 1/4" NPT IN TS	7"	1/4"	233	336	107
RA1371421	DP 7 TRIO 3/4" NPT IN TS	7"	3/4"	233	336	107
RA1371721	DP 7 TRIO 1" NPT IN TS	7"	1"	233	336	107
RA1400121	DP 10 TRIO 1/4" NPT IN TS	10"	1/4"	325	336	107
RA1400421	DP 10 TRIO 3/4" NPT IN TS	10"	3/4"	325	336	107
RA1400721	DP 10 TRIO 1" NPT IN TS	10"	1"	325	336	107
RA1401421	DP 20 TRIO 3/4" NPT IN TS	20"	3/4"	577	336	107
RA1401721	DP 20 TRIO 1" NPT IN TS	20"	1"	577	336	107

## VARIANTS AVAILABLE ON MINIMUM QUANTITY:

- RT housings suitable for filter cartridges with length 508 mm

Some items in the list are subject to minimum order quantities and/or to longer delivery term.

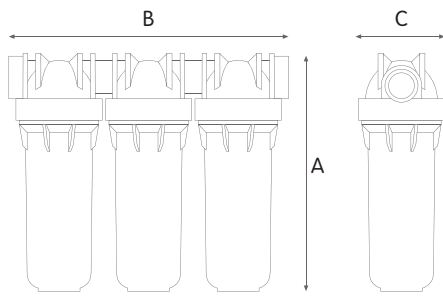

**WORKING CONDITIONS**

Max working pressure:  
 BSP versions \_\_\_\_\_ 8 bar (116 psi)  
 NPT versions \_\_\_\_\_ 8,6 bar (125 psi)  
 Max working temperature \_\_\_\_\_ 45°C (113°F)  
 Min working temperature \_\_\_\_\_ 4°C (39,2°F)

**SPECIFICATIONS**

Non-toxic materials, suitable for drinking water.  
 Head: reinforced polypropylene.  
 Bowls: PET.  
 O-rings: EPDM.  
 Breather-valve: body stainless steel, o-ring EPDM.  
 IN/OUT brass threads: CW 617 N brass.

**DP TRIO blue housings**

**HOUSINGS WITH BRASS BSP THREADS**

CODE	MODEL	SUITABLE CARTRIDGE	IN/OUT	DIMENSIONS mm		
				A	B	C
RA1370302	DP 5 TRIO 1/2" OT AB	5"	1/2"	185	336	107
RA1370402	DP 5 TRIO 3/4" OT AB	5"	3/4"	185	336	107
RA1370702	DP 5 TRIO 1" OT AB	5"	1"	185	336	107
RA1371302	DP 7 TRIO 1/2" OT AB	7"	1/2"	233	336	107
RA1371402	DP 7 TRIO 3/4" OT AB	7"	3/4"	233	336	107
RA1371702	DP 7 TRIO 1" OT AB	7"	1"	233	336	107
RA1400302	DP 10 TRIO 1/2" OT AB	10"	1/2"	325	336	107
RA1400402	DP 10 TRIO 3/4" OT AB	10"	3/4"	325	336	107
RA1400702	DP 10 TRIO 1" OT AB	10"	1"	325	336	107
RA1401302	DP 20 TRIO 1/2" OT AB	20"	1/2"	577	336	107
RA1401402	DP 20 TRIO 3/4" OT AB	20"	3/4"	577	336	107
RA1401702	DP 20 TRIO 1" OT AB	20"	1"	577	336	107

**HOUSINGS WITH PLASTIC BSP THREADS**

CODE	MODEL	SUITABLE CARTRIDGE	IN/OUT	DIMENSIONS mm		
				A	B	C
RA1370102	DP 5 TRIO 1/4" IN AB	5"	1/4"	185	336	107
RA1370312	DP 5 TRIO 1/2" IN AB	5"	1/2"	185	336	107
RA1370412	DP 5 TRIO 3/4" IN AB	5"	3/4"	185	336	107
RA1370712	DP 5 TRIO 1" IN AB	5"	1"	185	336	107
RA1371102	DP 7 TRIO 1/4" IN AB	7"	1/4"	233	336	107
RA1371312	DP 7 TRIO 1/2" IN AB	7"	1/2"	233	336	107
RA1371412	DP 7 TRIO 3/4" IN AB	7"	3/4"	233	336	107
RA1371712	DP 7 TRIO 1" IN AB	7"	1"	233	336	107
RA1400102	DP 10 TRIO 1/4" IN AB	10"	1/4"	325	336	107
RA1400312	DP 10 TRIO 1/2" IN AB	10"	1/2"	325	336	107
RA1400412	DP 10 TRIO 3/4" IN AB	10"	3/4"	325	336	107
RA1400712	DP 10 TRIO 1" IN AB	10"	1"	325	336	107
RA1401312	DP 20 TRIO 1/2" IN AB	20"	1/2"	577	336	107
RA1401412	DP 20 TRIO 3/4" IN AB	20"	3/4"	577	336	107
RA1401712	DP 20 TRIO 1" IN AB	20"	1"	577	336	107

**HOUSINGS WITH PLASTIC NPT THREADS**

CODE	MODEL	SUITABLE CARTRIDGE	IN/OUT	DIMENSIONS mm		
				A	B	C
RA1370122	DP 5 TRIO 1/4" NPT IN AB	5"	1/4"	185	336	107
RA1370322	DP 5 TRIO 3/4" NPT IN AB	5"	3/4"	185	336	107
RA1370722	DP 5 TRIO 1" NPT IN AB	5"	1"	185	336	107
RA1371122	DP 7 TRIO 1/4" NPT IN AB	7"	1/4"	233	336	107
RA1371422	DP 7 TRIO 3/4" NPT IN AB	7"	3/4"	233	336	107
RA1371722	DP 7 TRIO 1" NPT IN AB	7"	1"	233	336	107
RA1400122	DP 10 TRIO 1/4" NPT IN AB	10"	1/4"	325	336	107
RA1400422	DP 10 TRIO 3/4" NPT IN AB	10"	3/4"	325	336	107
RA1400722	DP 10 TRIO 1" NPT IN AB	10"	1"	325	336	107
RA1401422	DP 20 TRIO 3/4" NPT IN AB	20"	3/4"	577	336	107
RA1401722	DP 20 TRIO 1" NPT IN AB	20"	1"	577	336	107

**VARIANTS AVAILABLE ON MINIMUM QUANTITY:**

- RT housings suitable for filter cartridges with length 508 mm

Some items in the list are subject to minimum order quantities and/or to longer delivery term.

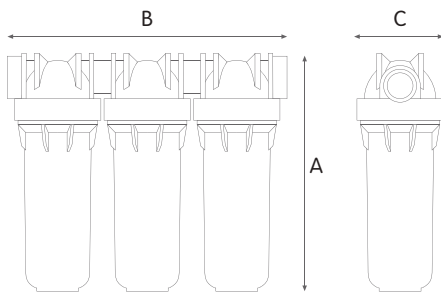

**WORKING CONDITIONS**

Max working pressure:  
 BSP versions \_\_\_\_\_ 8 bar (116 psi)  
 NPT versions \_\_\_\_\_ 8,6 bar (125 psi)  
 Max working temperature \_\_\_\_\_ 45°C (113°F)  
 Min working temperature \_\_\_\_\_ 4°C (39,2°F)

**SPECIFICATIONS**

Non-toxic materials, suitable for drinking water.  
 Head: reinforced polypropylene.  
 Bowls: PET.  
 O-rings: EPDM.  
 Breather-valve: body stainless steel, o-ring EPDM.  
 IN/OUT brass threads: CW 617 N brass.

**DP TRIO white housings**

**HOUSINGS WITH BRASS BSP THREADS**

CODE	MODEL	SUITABLE CARTRIDGE	IN/OUT	DIMENSIONS mm		
				A	B	C
RA1370306	DP 5 TRIO 1/2" OT BW	5"	1/2"	185	336	107
RA1370406	DP 5 TRIO 3/4" OT BW	5"	3/4"	185	336	107
RA1370706	DP 5 TRIO 1" OT BW	5"	1"	185	336	107
RA1371306	DP 7 TRIO 1/2" OT BW	7"	1/2"	233	336	107
RA1371406	DP 7 TRIO 3/4" OT BW	7"	3/4"	233	336	107
RA1371706	DP 7 TRIO 1" OT BW	7"	1"	233	336	107
RA1400306	DP 10 TRIO 1/2" OT BW	10"	1/2"	325	336	107
RA1400406	DP 10 TRIO 3/4" OT BW	10"	3/4"	325	336	107
RA1400706	DP 10 TRIO 1" OT BW	10"	1"	325	336	107
RA1401306	DP 20 TRIO 1/2" OT BW	20"	1/2"	577	336	107
RA1401406	DP 20 TRIO 3/4" OT BW	20"	3/4"	577	336	107
RA1401706	DP 20 TRIO 1" OT BW	20"	1"	577	336	107

**HOUSINGS WITH PLASTIC BSP THREADS**

CODE	MODEL	SUITABLE CARTRIDGE	IN/OUT	DIMENSIONS mm		
				A	B	C
RA1370106	DP 5 TRIO 1/4" IN BW	5"	1/4"	185	336	107
RA1370316	DP 5 TRIO 1/2" IN BW	5"	1/2"	185	336	107
RA1370416	DP 5 TRIO 3/4" IN BW	5"	3/4"	185	336	107
RA1370716	DP 5 TRIO 1" IN BW	5"	1"	185	336	107
RA1371106	DP 7 TRIO 1/4" IN BW	7"	1/4"	233	336	107
RA1371316	DP 7 TRIO 1/2" IN BW	7"	1/2"	233	336	107
RA1371416	DP 7 TRIO 3/4" IN BW	7"	3/4"	233	336	107
RA1371716	DP 7 TRIO 1" IN BW	7"	1"	233	336	107
RA1400106	DP 10 TRIO 1/4" IN BW	10"	1/4"	325	336	107
RA1400316	DP 10 TRIO 1/2" IN BW	10"	1/2"	325	336	107
RA1400416	DP 10 TRIO 3/4" IN BW	10"	3/4"	325	336	107
RA1400716	DP 10 TRIO 1" IN BW	10"	1"	325	336	107
RA1401316	DP 20 TRIO 1/2" IN BW	20"	1/2"	577	336	107
RA1401416	DP 20 TRIO 3/4" IN BW	20"	3/4"	577	336	107
RA1401716	DP 20 TRIO 1" IN BW	20"	1"	577	336	107

**HOUSINGS WITH PLASTIC NPT THREADS**

CODE	MODEL	SUITABLE CARTRIDGE	IN/OUT	DIMENSIONS mm		
				A	B	C
RA1370126	DP 5 TRIO 1/4" NPT IN BW	5"	1/4"	185	336	107
RA1370426	DP 5 TRIO 3/4" NPT IN BW	5"	3/4"	185	336	107
RA1370726	DP 5 TRIO 1" NPT IN BW	5"	1"	185	336	107
RA1371126	DP 7 TRIO 1/4" NPT IN BW	7"	1/4"	233	336	107
RA1371426	DP 7 TRIO 3/4" NPT IN BW	7"	3/4"	233	336	107
RA1371726	DP 7 TRIO 1" NPT IN BW	7"	1"	233	336	107
RA1400126	DP 10 TRIO 1/4" NPT IN BW	10"	1/4"	325	336	107
RA1400426	DP 10 TRIO 3/4" NPT IN BW	10"	3/4"	325	336	107
RA1400726	DP 10 TRIO 1" NPT IN BW	10"	1"	325	336	107
RA1401426	DP 20 TRIO 3/4" NPT IN BW	20"	3/4"	577	336	107
RA1401726	DP 20 TRIO 1" NPT IN BW	20"	1"	577	336	107

**VARIANTS AVAILABLE ON MINIMUM QUANTITY:**

- RT housings suitable for filter cartridges with length 508 mm

Some items in the list are subject to minimum order quantities and/or to longer delivery term.



# SANIC

WATER FILTERS WITH  
ANTIMICROBIAL  
TECHNOLOGY

## DP SANIC

filter housings with antimicrobial technology  
for cartridges SX and BX

Range of housings with antimicrobial product protection  
provided by a silver based antimicrobial agent  
included in the plastic matrix with a specific injection  
molding technology



DP FILTER  
HOUSINGS

Powered by Microban® antimicrobial technology



**MICROBAN**

Microban® technology is not designed to purify drinking water, but to fight the growth of stain and odor causing bacteria on the housing and filter itself which could adversely affect filter life and performance.  
MICROBAN is a registered trademark of Microban Products Company.



# HOUSINGS DP SANIC

FOR CARTRIDGES SX and BX

**Housings DP SANIC fit to both SANIC SX (DOE) cartridges and to exclusive SANIC BX cartridges with 45 mm double o-ring collar.**

The full range of Atlas Filtri® SANIC SX and BX cartridges is suitable to DP SANIC housings and provides the widest range of water filtration units with ANTIMICROBIAL TECHNOLOGY.

DP SANIC housings are designed to work in combination with SANIC filter cartridges provided with the same antimicrobial technology and to keep the filter cleaner for longer in every single pore of their structure.

**DP SANIC housings are available as MONO, DUO and TRIO models.**

DP SANIC housings are suitable for every Point-of-Use (POU) and Point-of-Entry (POE) application, as single or multi-stage on-line filters. Thanks to the antimicrobial protection SANIC housings with SANIC filter cartridges are the most reliable sediment filtration systems for all drinking water application by keeping the filter cleaner for longer.

DP SANIC housings are manufactured with the finest and most advanced materials under constant focus on innovative processing technologies and ceaseless modernization to ensure the absolute quality of our products.

SANIC is a registered trademark of ATLAS FILTRI srl.



## SX SANIC

cartridges with standard flat seals.



## BX SANIC

cartridges with 45 mm double o-ring collar.  
Quick-fit connection for a perfect tightening.

### CERTIFICATIONS



Systems tested and certified by IAPMO RT against NSF/ANSI 42 for bacteriostasis effect. Components tested and certified by IAPMO RT against NSF/ANSI Standards 42 and 61 for material and structural integrity requirements only. In compliance with Drinking Water Treatment Units regulations, USA and Canada.



Housings are tested and certified under the most stringent procedures worldwide, in compliance with DM 25 (Italy), with the sanitary certification ACS (France), EAC/Ghostreghistracia (Russia) and WaterMark (Australia).

### SYMBOLS LEGEND



For domestic use



For technical and industrial use



Filter housings made in PET, a highly recyclable plastic, are manufactured with a proprietary procedure saving up to 60% of energy in injection molding compared with standard plastics. That is one of Atlas Filtri commitments for the reduction of green house gas (CO<sub>2</sub>) emissions in the atmosphere.

### ACCESSORIES INCLUDED



-X- spanner



-S- wall bracket



-DUO- wall bracket



-TRIO- wall bracket

### ACCESSORIES ON DEMAND



3/4" brass nipples with o-ring (pair) CODE RB7404001

1" brass nipples with o-ring (pair) CODE RB7404002



3/4" plastic nipple with o-ring CODE LB7404012



3/4"-1/4" plastic reduction with o-ring CODE LB9020611



-LUBRIKIT- single-dose lubricant for housing o-ring  
CODE RE9020650



DP	10	MONO	3/4"	OT	SANIC TS
HOUSINGS MODEL	HOUSINGS HEIGHT	VERSION	IN / OUT	THREADS TYPE	BOWL TYPE
		MONO	1/4" 3/8" 1/2" 3/4" 1"	OT - BRASS BSP*	SANIC TS - CLEAR BOWL WITH ANTI-MICROBIAL AGENT
				IN - PLASTIC BSP*	SANIC BG - OPAQUE BOWL WITH ANTI-MICROBIAL AGENT
				NPT IN - PLASTIC NPT**	
		DUO			
		TRIO			
				<p>* BSP parallel (cylindrical) ISO 228</p> 	<p>** NPT tapered (conical) ANSI/ASME B1.20.1</p> 



# DP MONO SANIC

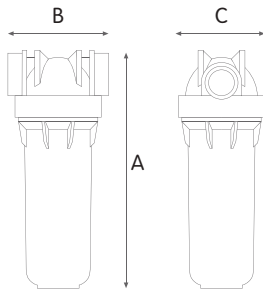

## WORKING CONDITIONS

Max working pressure:  
 BSP versions \_\_\_\_\_ 8 bar (116 psi)  
 NPT versions \_\_\_\_\_ 8,6 bar (125 psi)  
 Max working temperature \_\_\_\_\_ 45°C (113°F)  
 Min working temperature \_\_\_\_\_ 4°C (39,2°F)

## SPECIFICATIONS

Non-toxic materials, suitable for drinking water.  
 Head: reinforced polypropylene.  
 Bowl: PET with antimicrobial technology.  
 O-ring: EPDM.  
 Breather-valve: body stainless steel, o-ring EPDM.  
 IN/OUT brass threads: CW 617 N brass.

## DP MONO SANIC clear housings

### HOUSINGS WITH BRASS BSP THREADS

CODE	MODEL	SUITABLE CARTRIDGE	IN/OUT	DIMENSIONS mm		
				A	B	C
SA1350301	DP 5 MONO 1/2" OT SANIC TS	5"	1/2"	185	122	107
SA1350401	DP 5 MONO 3/4" OT SANIC TS	5"	3/4"	185	122	107
SA1350701	DP 5 MONO 1" OT SANIC TS	5"	1"	185	122	107
SA1351301	DP 7 MONO 1/2" OT SANIC TS	7"	1/2"	233	122	107
SA1351401	DP 7 MONO 3/4" OT SANIC TS	7"	3/4"	233	122	107
SA1351701	DP 7 MONO 1" OT SANIC TS	7"	1"	233	122	107
SA1380301	DP 10 MONO 1/2" OT SANIC TS	10"	1/2"	325	122	107
SA1380401	DP 10 MONO 3/4" OT SANIC TS	10"	3/4"	325	122	107
SA1380701	DP 10 MONO 1" OT SANIC TS	10"	1"	325	122	107
SA1381301	DP 20 MONO 1/2" OT SANIC TS	20"	1/2"	577	122	107
SA1381401	DP 20 MONO 3/4" OT SANIC TS	20"	3/4"	577	122	107
SA1381701	DP 20 MONO 1" OT SANIC TS	20"	1"	577	122	107

### HOUSINGS WITH PLASTIC BSP THREADS

CODE	MODEL	SUITABLE CARTRIDGE	IN/OUT	DIMENSIONS mm		
				A	B	C
SA1350101	DP 5 MONO 1/4" IN SANIC TS	5"	1/4"	185	122	107
SA1350201	DP 5 MONO 3/8" IN SANIC TS	5"	3/8"	185	122	107
SA1350311	DP 5 MONO 1/2" IN SANIC TS	5"	1/2"	185	122	107
SA1350411	DP 5 MONO 3/4" IN SANIC TS	5"	3/4"	185	122	107
SA1350711	DP 5 MONO 1" IN SANIC TS	5"	1"	185	122	107
SA1351101	DP 7 MONO 1/4" IN SANIC TS	7"	1/4"	233	122	107
SA1351201	DP 7 MONO 3/8" IN SANIC TS	7"	3/8"	233	122	107
SA1351311	DP 7 MONO 1/2" IN SANIC TS	7"	1/2"	233	122	107
SA1351411	DP 7 MONO 3/4" IN SANIC TS	7"	3/4"	233	122	107
SA1351711	DP 7 MONO 1" IN SANIC TS	7"	1"	233	122	107
SA1380101	DP 10 MONO 1/4" IN SANIC TS	10"	1/4"	325	122	107
SA1380201	DP 10 MONO 3/8" IN SANIC TS	10"	3/8"	325	122	107
SA1380311	DP 10 MONO 1/2" IN SANIC TS	10"	1/2"	325	122	107
SA1380411	DP 10 MONO 3/4" IN SANIC TS	10"	3/4"	325	122	107
SA1380711	DP 10 MONO 1" IN SANIC TS	10"	1"	325	122	107
SA1381311	DP 20 MONO 1/2" IN SANIC TS	20"	1/2"	577	122	107
SA1381411	DP 20 MONO 3/4" IN SANIC TS	20"	3/4"	577	122	107
SA1381711	DP 20 MONO 1" IN SANIC TS	20"	1"	577	122	107

### HOUSINGS WITH PLASTIC NPT THREADS

CODE	MODEL	SUITABLE CARTRIDGE	IN/OUT	DIMENSIONS mm		
				A	B	C
SA1350121	DP 5 MONO 1/4" NPT IN SANIC TS	5"	1/4"	185	122	107
SA1350321	DP 5 MONO 1/2" NPT IN SANIC TS	5"	1/2"	185	122	107
SA1350421	DP 5 MONO 3/4" NPT IN SANIC TS	5"	3/4"	185	122	107
SA1350721	DP 5 MONO 1" NPT IN SANIC TS	5"	1"	185	122	107
SA1351121	DP 7 MONO 1/4" NPT IN SANIC TS	7"	1/4"	233	122	107
SA1351321	DP 7 MONO 1/2" NPT IN SANIC TS	7"	1/2"	233	122	107
SA1351421	DP 7 MONO 3/4" NPT IN SANIC TS	7"	3/4"	233	122	107
SA1351721	DP 7 MONO 1" NPT IN SANIC TS	7"	1"	233	122	107
SA1380121	DP 10 MONO 1/4" NPT IN SANIC TS	10"	1/4"	325	122	107
SA1380321	DP 10 MONO 1/2" NPT IN SANIC TS	10"	1/2"	325	122	107
SA1380421	DP 10 MONO 3/4" NPT IN SANIC TS	10"	3/4"	325	122	107
SA1380721	DP 10 MONO 1" NPT IN SANIC TS	10"	1"	325	122	107
SA1381321	DP 20 MONO 1/2" NPT IN SANIC TS	20"	1/2"	577	122	107
SA1381421	DP 20 MONO 3/4" NPT IN SANIC TS	20"	3/4"	577	122	107
SA1381721	DP 20 MONO 1" NPT IN SANIC TS	20"	1"	577	122	107

## VARIANTS AVAILABLE ON MINIMUM QUANTITY:

- RT housings suitable for filter cartridges with length 508 mm

Some items in the list are subject to minimum order quantities and/or to longer delivery term.

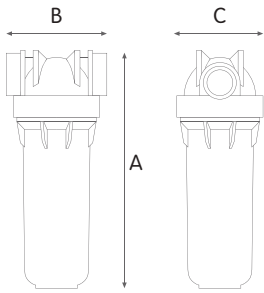

**WORKING CONDITIONS**

Max working pressure:  
 BSP versions \_\_\_\_\_ 8 bar (116 psi)  
 NPT versions \_\_\_\_\_ 8,6 bar (125 psi)  
 Max working temperature \_\_\_\_\_ 45°C (113°F)  
 Min working temperature \_\_\_\_\_ 4°C (39,2°F)

**SPECIFICATIONS**

Non-toxic materials, suitable for drinking water.  
 Head: reinforced polypropylene.  
 Bowl: reinforced polypropylene with antimicrobial technology.  
 O-ring: EPDM.  
 Breather-valve: body stainless steel, o-ring EPDM.  
 IN/OUT brass threads: CW 617 N brass.

**DP MONO SANIC grey housings**

**HOUSINGS WITH BRASS BSP THREADS**

CODE	MODEL	SUITABLE CARTRIDGE	IN/OUT	DIMENSIONS mm		
				A	B	C
SA1380302	DP 10 MONO 1/2" OT SANIC BG	10"	1/2"	325	122	107
SA1380402	DP 10 MONO 3/4" OT SANIC BG	10"	3/4"	325	122	107
SA1380702	DP 10 MONO 1" OT SANIC BG	10"	1"	325	122	107
SA1381302	DP 20 MONO 1/2" OT SANIC BG	20"	1/2"	577	122	107
SA1381402	DP 20 MONO 3/4" OT SANIC BG	20"	3/4"	577	122	107
SA1381702	DP 20 MONO 1" OT SANIC BG	20"	1"	577	122	107

**HOUSINGS WITH PLASTIC BSP THREADS**

CODE	MODEL	SUITABLE CARTRIDGE	IN/OUT	DIMENSIONS mm		
				A	B	C
SA1380106	DP 10 MONO 1/4" IN SANIC BG	10"	1/4"	325	122	107
SA1380202	DP 10 MONO 3/8" IN SANIC BG	10"	3/8"	325	122	107
SA1380312	DP 10 MONO 1/2" IN SANIC BG	10"	1/2"	325	122	107
SA1380412	DP 10 MONO 3/4" IN SANIC BG	10"	3/4"	325	122	107
SA1380712	DP 10 MONO 1" IN SANIC BG	10"	1"	325	122	107
SA1381312	DP 20 MONO 1/2" IN SANIC BG	20"	1/2"	577	122	107
SA1381412	DP 20 MONO 3/4" IN SANIC BG	20"	3/4"	577	122	107
SA1381712	DP 20 MONO 1" IN SANIC BG	20"	1"	577	122	107

**HOUSINGS WITH PLASTIC NPT THREADS**

CODE	MODEL	SUITABLE CARTRIDGE	IN/OUT	DIMENSIONS mm		
				A	B	C
SA1380122	DP 10 MONO 1/4" NPT IN SANIC BG	10"	1/4"	325	122	107
SA1380322	DP 10 MONO 1/2" NPT IN SANIC BG	10"	1/2"	325	122	107
SA1380422	DP 10 MONO 3/4" NPT IN SANIC BG	10"	3/4"	325	122	107
SA1380722	DP 10 MONO 1" NPT IN SANIC BG	10"	1"	325	122	107
SA1381322	DP 20 MONO 1/2" NPT IN SANIC BG	20"	1/2"	577	122	107
SA1381422	DP 20 MONO 3/4" NPT IN SANIC BG	20"	3/4"	577	122	107
SA1381722	DP 20 MONO 1" NPT IN SANIC BG	20"	1"	577	122	107

**VARIANTS AVAILABLE ON MINIMUM QUANTITY:**

- RT housings suitable for filter cartridges with length 508 mm

Some items in the list are subject to minimum order quantities and/or to longer delivery term.



# DP DUO SANIC

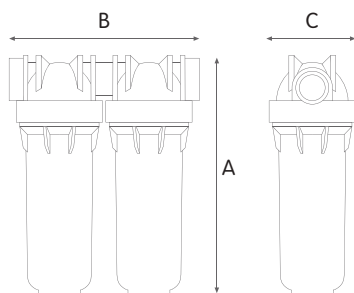

## WORKING CONDITIONS

Max working pressure:  
 BSP versions \_\_\_\_\_ 8 bar (116 psi)  
 NPT versions \_\_\_\_\_ 8,6 bar (125 psi)  
 Max working temperature \_\_\_\_\_ 45°C (113°F)  
 Min working temperature \_\_\_\_\_ 4°C (39,2°F)

## SPECIFICATIONS

Non-toxic materials, suitable for drinking water.  
 Head: reinforced polypropylene.  
 Bowl: PET with antimicrobial technology.  
 O-ring: EPDM.  
 Breather-valve: body stainless steel, o-ring EPDM.  
 IN/OUT brass threads: CW 617 N brass.

## DP DUO SANIC clear housings

### HOUSINGS WITH BRASS BSP THREADS

CODE	MODEL	SUITABLE CARTRIDGE	IN/OUT	DIMENSIONS mm		
				A	B	C
SA1360301	DP 5 DUO 1/2" OT SANIC TS	5"	1/2"	185	228	107
SA1360401	DP 5 DUO 3/4" OT SANIC TS	5"	3/4"	185	228	107
SA1360701	DP 5 DUO 1" OT SANIC TS	5"	1"	185	228	107
SA1361301	DP 7 DUO 1/2" OT SANIC TS	7"	1/2"	233	228	107
SA1361401	DP 7 DUO 3/4" OT SANIC TS	7"	3/4"	233	228	107
SA1361701	DP 7 DUO 1" OT SANIC TS	7"	1"	233	228	107
SA1390301	DP 10 DUO 1/2" OT SANIC TS	10"	1/2"	325	228	107
SA1390401	DP 10 DUO 3/4" OT SANIC TS	10"	3/4"	325	228	107
SA1390701	DP 10 DUO 1" OT SANIC TS	10"	1"	325	228	107
SA1391301	DP 20 DUO 1/2" OT SANIC TS	20"	1/2"	577	228	107
SA1391401	DP 20 DUO 3/4" OT SANIC TS	20"	3/4"	577	228	107
SA1391701	DP 20 DUO 1" OT SANIC TS	20"	1"	577	228	107

### HOUSINGS WITH PLASTIC BSP THREADS

CODE	MODEL	SUITABLE CARTRIDGE	IN/OUT	DIMENSIONS mm		
				A	B	C
SA1360101	DP 5 DUO 1/4" IN SANIC TS	5"	1/4"	185	228	107
SA1360311	DP 5 DUO 1/2" IN SANIC TS	5"	1/2"	185	228	107
SA1360411	DP 5 DUO 3/4" IN SANIC TS	5"	3/4"	185	228	107
SA1360711	DP 5 DUO 1" IN SANIC TS	5"	1"	185	228	107
SA1361101	DP 7 DUO 1/4" IN SANIC TS	7"	1/4"	233	228	107
SA1361311	DP 7 DUO 1/2" IN SANIC TS	7"	1/2"	233	228	107
SA1361411	DP 7 DUO 3/4" IN SANIC TS	7"	3/4"	233	228	107
SA1361711	DP 7 DUO 1" IN SANIC TS	7"	1"	233	228	107
SA1390101	DP 10 DUO 1/4" IN SANIC TS	10"	1/4"	325	228	107
SA1390311	DP 10 DUO 1/2" IN SANIC TS	10"	1/2"	325	228	107
SA1390411	DP 10 DUO 3/4" IN SANIC TS	10"	3/4"	325	228	107
SA1390711	DP 10 DUO 1" IN SANIC TS	10"	1"	325	228	107
SA1391311	DP 20 DUO 1/2" IN SANIC TS	20"	1/2"	577	228	107
SA1391411	DP 20 DUO 3/4" IN SANIC TS	20"	3/4"	577	228	107
SA1391711	DP 20 DUO 1" IN SANIC TS	20"	1"	577	228	107

### HOUSINGS WITH PLASTIC NPT THREADS

CODE	MODEL	SUITABLE CARTRIDGE	IN/OUT	DIMENSIONS mm		
				A	B	C
SA1360121	DP 5 DUO 1/4" NPT IN SANIC TS	5"	1/4"	185	228	107
SA1360421	DP 5 DUO 3/4" NPT IN SANIC TS	5"	3/4"	185	228	107
SA1360721	DP 5 DUO 1" NPT IN SANIC TS	5"	1"	185	228	107
SA1361121	DP 7 DUO 1/4" NPT IN SANIC TS	7"	1/4"	233	228	107
SA1361421	DP 7 DUO 3/4" NPT IN SANIC TS	7"	3/4"	233	228	107
SA1361721	DP 7 DUO 1" NPT IN SANIC TS	7"	1"	233	228	107
SA1390121	DP 10 DUO 1/4" NPT IN SANIC TS	10"	1/4"	325	228	107
SA1390421	DP 10 DUO 3/4" NPT IN SANIC TS	10"	3/4"	325	228	107
SA1390721	DP 10 DUO 1" NPT IN SANIC TS	10"	1"	325	228	107
SA1391421	DP 20 DUO 3/4" NPT IN SANIC TS	20"	3/4"	577	228	107
SA1391721	DP 20 DUO 1" NPT IN SANIC TS	20"	1"	577	228	107

## VARIANTS AVAILABLE ON MINIMUM QUANTITY:

- RT housings suitable for filter cartridges with length 508 mm

Some items in the list are subject to minimum order quantities and/or to longer delivery term.

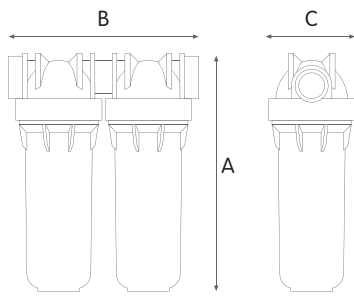

**WORKING CONDITIONS**

Max working pressure:  
 BSP versions \_\_\_\_\_ 8 bar (116 psi)  
 NPT versions \_\_\_\_\_ 8,6 bar (125 psi)  
 Max working temperature \_\_\_\_\_ 45°C (113°F)  
 Min working temperature \_\_\_\_\_ 4°C (39,2°F)

**SPECIFICATIONS**

Non-toxic materials, suitable for drinking water.  
 Head: reinforced polypropylene.  
 Bowl: reinforced polypropylene with antimicrobial technology.  
 O-ring: EPDM.  
 Breather-valve: body stainless steel, o-ring EPDM.  
 IN/OUT brass threads: CW 617 N brass.

**DP DUO SANIC grey housings**

**HOUSINGS WITH BRASS BSP THREADS**

CODE	MODEL	SUITABLE CARTRIDGE	IN/OUT	DIMENSIONS mm		
				A	B	C
SA1390302	DP 10 DUO 1/2" OT SANIC BG	10"	1/2"	325	228	107
SA1390402	DP 10 DUO 3/4" OT SANIC BG	10"	3/4"	325	228	107
SA1390702	DP 10 DUO 1" OT SANIC BG	10"	1"	325	228	107
SA1391302	DP 20 DUO 1/2" OT SANIC BG	20"	1/2"	577	228	107
SA1391402	DP 20 DUO 3/4" OT SANIC BG	20"	3/4"	577	228	107
SA1391702	DP 20 DUO 1" OT SANIC BG	20"	1"	577	228	107

**HOUSINGS WITH PLASTIC BSP THREADS**

CODE	MODEL	SUITABLE CARTRIDGE	IN/OUT	DIMENSIONS mm		
				A	B	C
SA1390106	DP 10 DUO 1/4" IN SANIC BG	10"	1/4"	325	228	107
SA1390312	DP 10 DUO 1/2" IN SANIC BG	10"	1/2"	325	228	107
SA1390412	DP 10 DUO 3/4" IN SANIC BG	10"	3/4"	325	228	107
SA1390712	DP 10 DUO 1" IN SANIC BG	10"	1"	325	228	107
SA1391312	DP 20 DUO 1/2" IN SANIC BG	20"	1/2"	577	228	107
SA1391412	DP 20 DUO 3/4" IN SANIC BG	20"	3/4"	577	228	107
SA1391712	DP 20 DUO 1" IN SANIC BG	20"	1"	577	228	107

**HOUSINGS WITH PLASTIC NPT THREADS**

CODE	MODEL	SUITABLE CARTRIDGE	IN/OUT	DIMENSIONS mm		
				A	B	C
SA1390122	DP 10 DUO 1/4" NPT IN SANIC BG	10"	1/4"	325	228	107
SA1390422	DP 10 DUO 3/4" NPT IN SANIC BG	10"	3/4"	325	228	107
SA1390722	DP 10 DUO 1" NPT IN SANIC BG	10"	1"	325	228	107
SA1391422	DP 20 DUO 3/4" NPT IN SANIC BG	20"	3/4"	577	228	107
SA1391722	DP 20 DUO 1" NPT IN SANIC BG	20"	1"	577	228	107

**VARIANTS AVAILABLE ON MINIMUM QUANTITY:**

- RT housings suitable for filter cartridges with length 508 mm

Some items in the list are subject to minimum order quantities and/or to longer delivery term.





# DP TRIO SANIC

## WORKING CONDITIONS

Max working pressure:  
 BSP versions \_\_\_\_\_ 8 bar (116 psi)  
 NPT versions \_\_\_\_\_ 8,6 bar (125 psi)  
 Max working temperature \_\_\_\_\_ 45°C (113°F)  
 Min working temperature \_\_\_\_\_ 4°C (39,2°F)

## SPECIFICATIONS

Non-toxic materials, suitable for drinking water.  
 Head: reinforced polypropylene.  
 Bowl: PET with antimicrobial technology.  
 O-ring: EPDM.  
 Breather-valve: body stainless steel, o-ring EPDM.  
 IN/OUT brass threads: CW 617 N brass.

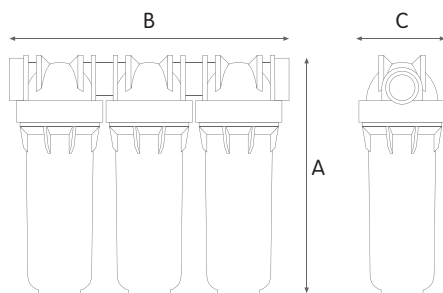

## DP TRIO SANIC clear housings

### HOUSINGS WITH BRASS BSP THREADS



CODE	MODEL	SUITABLE CARTRIDGE	IN/OUT	DIMENSIONS mm		
				A	B	C
SA1370301	DP 5 TRIO 1/2" OT SANIC TS	5"	1/2"	185	336	107
SA1370401	DP 5 TRIO 3/4" OT SANIC TS	5"	3/4"	185	336	107
SA1370701	DP 5 TRIO 1" OT SANIC TS	5"	1"	185	336	107
SA1371301	DP 7 TRIO 1/2" OT SANIC TS	7"	1/2"	233	336	107
SA1371401	DP 7 TRIO 3/4" OT SANIC TS	7"	3/4"	233	336	107
SA1371701	DP 7 TRIO 1" OT SANIC TS	7"	1"	233	336	107
SA1400301	DP 10 TRIO 1/2" OT SANIC TS	10"	1/2"	325	336	107
SA1400401	DP 10 TRIO 3/4" OT SANIC TS	10"	3/4"	325	336	107
SA1400701	DP 10 TRIO 1" OT SANIC TS	10"	1"	325	336	107
SA1401301	DP 20 TRIO 1/2" OT SANIC TS	20"	1/2"	577	336	107
SA1401401	DP 20 TRIO 3/4" OT SANIC TS	20"	3/4"	577	336	107
SA1401701	DP 20 TRIO 1" OT SANIC TS	20"	1"	577	336	107

### HOUSINGS WITH PLASTIC BSP THREADS



CODE	MODEL	SUITABLE CARTRIDGE	IN/OUT	DIMENSIONS mm		
				A	B	C
SA1370101	DP 5 TRIO 1/4" IN SANIC TS	5"	1/4"	185	336	107
SA1370311	DP 5 TRIO 1/2" IN SANIC TS	5"	1/2"	185	336	107
SA1370411	DP 5 TRIO 3/4" IN SANIC TS	5"	3/4"	185	336	107
SA1370711	DP 5 TRIO 1" IN SANIC TS	5"	1"	185	336	107
SA1371101	DP 7 TRIO 1/4" IN SANIC TS	7"	1/4"	233	336	107
SA1371311	DP 7 TRIO 1/2" IN SANIC TS	7"	1/2"	233	336	107
SA1371411	DP 7 TRIO 3/4" IN SANIC TS	7"	3/4"	233	336	107
SA1371711	DP 7 TRIO 1" IN SANIC TS	7"	1"	233	336	107
SA1400101	DP 10 TRIO 1/4" IN SANIC TS	10"	1/4"	325	336	107
SA1400311	DP 10 TRIO 1/2" IN SANIC TS	10"	1/2"	325	336	107
SA1400411	DP 10 TRIO 3/4" IN SANIC TS	10"	3/4"	325	336	107
SA1400711	DP 10 TRIO 1" IN SANIC TS	10"	1"	325	336	107
SA1401311	DP 20 TRIO 1/2" IN SANIC TS	20"	1/2"	577	336	107
SA1401411	DP 20 TRIO 3/4" IN SANIC TS	20"	3/4"	577	336	107
SA1401711	DP 20 TRIO 1" IN SANIC TS	20"	1"	577	336	107

### HOUSINGS WITH PLASTIC NPT THREADS

CODE	MODEL	SUITABLE CARTRIDGE	IN/OUT	DIMENSIONS mm		
				A	B	C
SA1370121	DP 5 TRIO 1/4" NPT IN SANIC TS	5"	1/4"	185	336	107
SA1370421	DP 5 TRIO 3/4" NPT IN SANIC TS	5"	3/4"	185	336	107
SA1370721	DP 5 TRIO 1" NPT IN SANIC TS	5"	1"	185	336	107
SA1371121	DP 7 TRIO 1/4" NPT IN SANIC TS	7"	1/4"	233	336	107
SA1371421	DP 7 TRIO 3/4" NPT IN SANIC TS	7"	3/4"	233	336	107
SA1371721	DP 7 TRIO 1" NPT IN SANIC TS	7"	1"	233	336	107
SA1400121	DP 10 TRIO 1/4" NPT IN SANIC TS	10"	1/4"	325	336	107
SA1400421	DP 10 TRIO 3/4" NPT IN SANIC TS	10"	3/4"	325	336	107
SA1400721	DP 10 TRIO 1" NPT IN SANIC TS	10"	1"	325	336	107
SA1401421	DP 20 TRIO 3/4" NPT IN SANIC TS	20"	3/4"	577	336	107
SA1401721	DP 20 TRIO 1" NPT IN SANIC TS	20"	1"	577	336	107

## VARIANTS AVAILABLE ON MINIMUM QUANTITY:

- RT housings suitable for filter cartridges with length 508 mm

Some items in the list are subject to minimum order quantities and/or to longer delivery term.

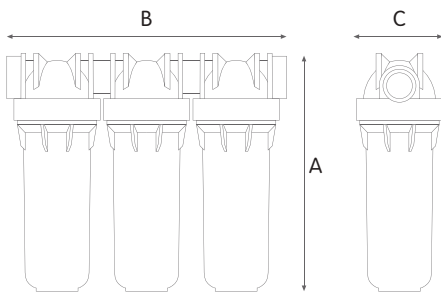

**WORKING CONDITIONS**

Max working pressure:  
 BSP versions \_\_\_\_\_ 8 bar (116 psi)  
 NPT versions \_\_\_\_\_ 8,6 bar (125 psi)  
 Max working temperature \_\_\_\_\_ 45°C (113°F)  
 Min working temperature \_\_\_\_\_ 4°C (39,2°F)

**SPECIFICATIONS**

Non-toxic materials, suitable for drinking water.  
 Head: reinforced polypropylene.  
 Bowl: reinforced polypropylene with antimicrobial technology.  
 O-ring: EPDM.  
 Breather-valve: body stainless steel, o-ring EPDM.  
 IN/OUT brass threads: CW 617 N brass.

**DP TRIO SANIC grey housings**

**HOUSINGS WITH BRASS BSP THREADS**

CODE	MODEL	SUITABLE CARTRIDGE	IN/OUT	DIMENSIONS mm		
				A	B	C
SA1400302	DP 10 TRIO 1/2" OT SANIC BG	10"	1/2"	325	336	107
SA1400402	DP 10 TRIO 3/4" OT SANIC BG	10"	3/4"	325	336	107
SA1400702	DP 10 TRIO 1" OT SANIC BG	10"	1"	325	336	107
SA1401302	DP 20 TRIO 1/2" OT SANIC BG	20"	1/2"	577	336	107
SA1401402	DP 20 TRIO 3/4" OT SANIC BG	20"	3/4"	577	336	107
SA1401702	DP 20 TRIO 1" OT SANIC BG	20"	1"	577	336	107

**HOUSINGS WITH PLASTIC BSP THREADS**

CODE	MODEL	SUITABLE CARTRIDGE	IN/OUT	DIMENSIONS mm		
				A	B	C
SA1400106	DP 10 TRIO 1/4" IN SANIC BG	10"	1/4"	325	336	107
SA1400312	DP 10 TRIO 1/2" IN SANIC BG	10"	1/2"	325	336	107
SA1400412	DP 10 TRIO 3/4" IN SANIC BG	10"	3/4"	325	336	107
SA1400712	DP 10 TRIO 1" IN SANIC BG	10"	1"	325	336	107
SA1401312	DP 20 TRIO 1/2" IN SANIC BG	20"	1/2"	577	336	107
SA1401412	DP 20 TRIO 3/4" IN SANIC BG	20"	3/4"	577	336	107
SA1401712	DP 20 TRIO 1" IN SANIC BG	20"	1"	577	336	107

**HOUSINGS WITH PLASTIC NPT THREADS**

CODE	MODEL	SUITABLE CARTRIDGE	IN/OUT	DIMENSIONS mm		
				A	B	C
SA1400122	DP 10 TRIO 1/4" NPT IN SANIC BG	10"	1/4"	325	336	107
SA1400422	DP 10 TRIO 3/4" NPT IN SANIC BG	10"	3/4"	325	336	107
SA1400722	DP 10 TRIO 1" NPT IN SANIC BG	10"	1"	325	336	107
SA1401422	DP 20 TRIO 3/4" NPT IN SANIC BG	20"	3/4"	577	336	107
SA1401722	DP 20 TRIO 1" NPT IN SANIC BG	20"	1"	577	336	107

**VARIANTS AVAILABLE ON MINIMUM QUANTITY:**

- RT housings suitable for filter cartridges with length 508 mm

Some items in the list are subject to minimum order quantities and/or to longer delivery term.





## DP DS

filter housings  
with rotational  
connection group  
for cartridges  
SX and BX

Brand new range  
of housings with  
360° rotational  
connection group  
for easy connection to  
horizontal or vertical pipes

# HOUSINGS DP DS

FOR CARTRIDGES SX and BX

**Housings DP DS fit to both standard SX (DOE) cartridges and to exclusive BX cartridges.**

The full range of Atlas Filtri® SX and BX cartridges is suitable to DP DS and provides the widest range of water filtration and treatment units.

DP DS housings are manufactured with the finest and most advanced materials under constant focus on innovative processing technologies and ceaseless modernization to ensure the absolute quality of our products.

**Housings DP DS with discharge valve** are provided with a drain funnel to protect potable water from pollution by back-flow, in compliance with **UNI EN 1717-11/2002**.



**SX** cartridges with standard flat seals.



**BX** cartridges with 45 mm double o-ring collar. Quick-fit connection for a perfect tightening.



**360°**

**MP** models with plastic connections at 3/4" and 1"



**DP DS MP models** come complete with 3/4" and 1" nipples all together in the package

MP group is made of a special high-resistance plastic, resulting from the most advanced research and development in materials and production processes.



**360°**

**MO** models with brass connections at 3/4" or 1"

## ACCESSORIES INCLUDED



-X- spanner



Filterfit - cartridge centering device

## DISCHARGE KIT FOR -S- MODEL



brass discharge ball-valve with gasket



plastic hose-holder



plastic nipple with o-ring



drain funnel

In compliance with the European Standard UNI EN 1717/2002: designed to prevent back-flow contamination by making all elements downstream the discharge vent to atmosphere (protection unit symbol: DC)

## ACCESSORIES ON DEMAND



-KIT AUTO- for S models CODE RE7120024 automatic discharge kit (see pages 186-187)



-LUBRIKIT- single-dose lubricant for housing o-ring CODE RE9020650

## SYMBOLS LEGEND



For domestic use



For technical and industrial use



Filter housings made in PET, a highly recyclable plastic, are manufactured with a proprietary procedure saving up to 60% of energy in injection molding compared with standard plastics. That is one of Atlas Filtri commitments to comply with Kyoto Treaty for the reduction of green house gas (CO<sub>2</sub>) emissions in the atmosphere.





DP FILTER HOUSINGS

<b>DP</b>	<b>10</b>	<b>DS</b>	<b>MP 3/4"-1"</b>	<b>TS</b>
HOUSINGS MODEL	HOUSINGS HEIGHT	VERSION	IN / OUT ROTATIONAL GROUP TYPE	BOWL TYPE
DP			MP 3/4"-1"	TS - CLEAR (PET)
			MO 3/4"	AB - BLUE (PET)
DP S			MO 1"	BW - WHITE (PET)
				

CERTIFICATIONS



Housings are tested and certified under the most stringent procedures worldwide, in compliance with DM 25 (Italy), with the sanitary certification EAC/ Ghostreghistrizia (Russia) and WaterMark (Australia).





# DP DS

## WORKING CONDITIONS

Max working pressure \_\_\_\_\_ 8 bar (116 psi)  
 Max working temperature \_\_\_\_\_ 45°C (113°F)  
 Min working temperature \_\_\_\_\_ 4°C (39,2°F)

## SPECIFICATIONS

Non-toxic materials, suitable for drinking water.  
 Head: reinforced polypropylene.  
 Bowl: PET.  
 O-rings: EPDM.  
 Breather-valve: body polypropylene, o-ring EPDM.  
 MP plastic rotational connection group: reinforced nylon.  
 Rotational connection group gaskets: NBR.

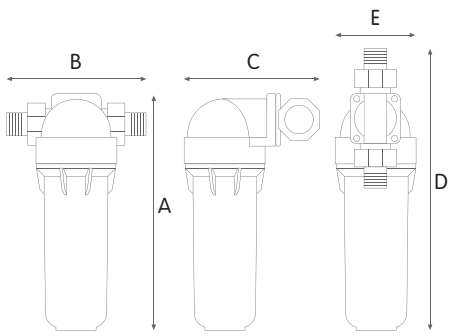

## DP DS MP with plastic rotational group

### CLEAR BOWL HOUSING MODELS

CODE	MODEL	SUITABLE CARTRIDGE	IN/OUT	DIMENSIONS mm		
				A	B	C
RA1410201	DP 5 DS MP 3/4"- 1" TS	5"	3/4" - 1"	206	172	170
RA1410301	DP 7 DS MP 3/4"- 1" TS	7"	3/4" - 1"	255	172	170
RA1410401	DP 10 DS MP 3/4"- 1" TS	10"	3/4" - 1"	331	172	170
RA1410501	DP 20 DS MP 3/4"- 1" TS	20"	3/4" - 1"	585	172	170



### BLUE BOWL HOUSING MODELS

CODE	MODEL	SUITABLE CARTRIDGE	IN/OUT	DIMENSIONS mm		
				A	B	C
RA1410202	DP 5 DS MP 3/4"- 1" AB	5"	3/4" - 1"	206	172	170
RA1410302	DP 7 DS MP 3/4"- 1" AB	7"	3/4" - 1"	255	172	170
RA1410402	DP 10 DS MP 3/4"- 1" AB	10"	3/4" - 1"	331	172	170
RA1410502	DP 20 DS MP 3/4"- 1" AB	20"	3/4" - 1"	585	172	170



### WHITE BOWL HOUSING MODELS

CODE	MODEL	SUITABLE CARTRIDGE	IN/OUT	DIMENSIONS mm		
				A	B	C
RA1410203	DP 5 DS MP 3/4"- 1" BW	5"	3/4" - 1"	206	172	170
RA1410303	DP 7 DS MP 3/4"- 1" BW	7"	3/4" - 1"	255	172	170
RA1410403	DP 10 DS MP 3/4"- 1" BW	10"	3/4" - 1"	331	172	170
RA1410503	DP 20 DS MP 3/4"- 1" BW	20"	3/4" - 1"	585	172	170

## VARIANTS AVAILABLE ON MINIMUM QUANTITY:

- RT housings suitable for filter cartridges with length 508 mm

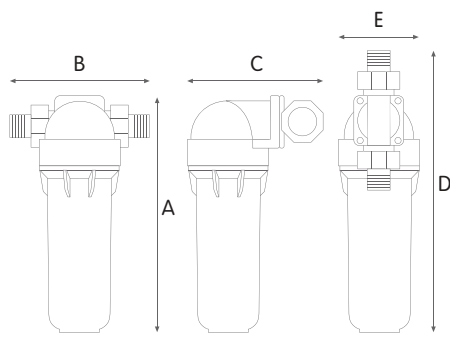

**WORKING CONDITIONS**

Max working pressure \_\_\_\_\_ 8 bar (116 psi)  
 Max working temperature \_\_\_\_\_ 45°C (113°F)  
 Min working temperature \_\_\_\_\_ 4°C (39,2°F)

**SPECIFICATIONS**

Non-toxic materials, suitable for drinking water.  
 Head: reinforced polypropylene.  
 Bowl: PET.  
 O-rings: EPDM.  
 Breather-valve: body polypropylene, o-ring EPDM.  
 MO brass rotational connection group: CW 617 N brass.  
 Rotational connection group gaskets: NBR.

**DP DS MO with brass rotational group**

**CLEAR BOWL HOUSING MODELS**

CODE	MODEL	SUITABLE CARTRIDGE	IN/OUT	DIMENSIONS mm		
				A	B	C
RA1410211	DP 5 DS MO 3/4" TS	5"	3/4"	206	164	164
RA1410221	DP 5 DS MO 1" TS	5"	1"	206	168	164
RA1410311	DP 7 DS MO 3/4" TS	7"	3/4"	255	164	164
RA1410321	DP 7 DS MO 1" TS	7"	1"	255	168	164
RA1410411	DP 10 DS MO 3/4" TS	10"	3/4"	331	164	164
RA1410711	DP 10 DS MO 1" TS	10"	1"	331	168	164
RA1410811	DP 20 DS MO 3/4" TS	20"	3/4"	585	164	164
RA1410911	DP 20 DS MO 1" TS	20"	1"	585	168	164

**BLUE BOWL HOUSING MODELS**

CODE	MODEL	SUITABLE CARTRIDGE	IN/OUT	DIMENSIONS mm		
				A	B	C
RA1410212	DP 5 DS MO 3/4" AB	5"	3/4"	206	164	164
RA1410222	DP 5 DS MO 1" AB	5"	1"	206	168	164
RA1410312	DP 7 DS MO 3/4" AB	7"	3/4"	255	164	164
RA1410322	DP 7 DS MO 1" AB	7"	1"	255	168	164
RA1410412	DP 10 DS MO 3/4" AB	10"	3/4"	331	164	164
RA1410712	DP 10 DS MO 1" AB	10"	1"	331	168	164
RA1410812	DP 20 DS MO 3/4" AB	20"	3/4"	585	164	164
RA1410912	DP 20 DS MO 1" AB	20"	1"	585	168	164

**WHITE BOWL HOUSING MODELS**

CODE	MODEL	SUITABLE CARTRIDGE	IN/OUT	DIMENSIONS mm		
				A	B	C
RA1410213	DP 5 DS MO 3/4" BW	5"	3/4"	206	164	164
RA1410223	DP 5 DS MO 1" BW	5"	1"	206	168	164
RA1410313	DP 7 DS MO 3/4" BW	7"	3/4"	255	164	164
RA1410323	DP 7 DS MO 1" BW	7"	1"	255	168	164
RA1410413	DP 10 DS MO 3/4" BW	10"	3/4"	331	164	164
RA1410713	DP 10 DS MO 1" BW	10"	1"	331	168	164
RA1410813	DP 20 DS MO 3/4" BW	20"	3/4"	585	164	164
RA1410913	DP 20 DS MO 1" BW	20"	1"	585	168	164

**VARIANTS AVAILABLE ON MINIMUM QUANTITY:**

- RT housings suitable for filter cartridges with length 508 mm



# DP S DS only for BX cartridges

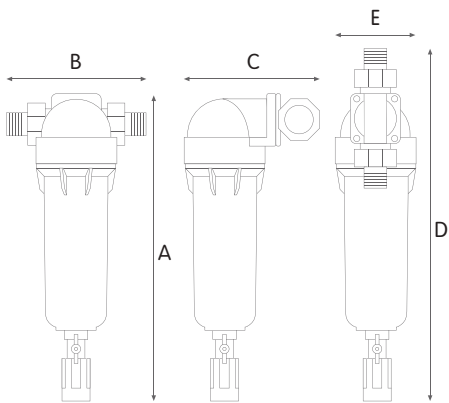

### WORKING CONDITIONS

Max working pressure \_\_\_\_\_ 8 bar (116 psi)  
 Max working temperature \_\_\_\_\_ 45°C (113°F)  
 Min working temperature \_\_\_\_\_ 4°C (39,2°F)

### SPECIFICATIONS

Non-toxic materials, suitable for drinking water.  
 Head: reinforced polypropylene.  
 Bowl: PET.  
 O-rings: EPDM.  
 Breather-valve: body polypropylene, o-ring EPDM.  
 MP plastic rotational connection group: reinforced nylon.  
 MO brass rotational connection group: CW 617 N brass.  
 Rotational connection group gaskets: NBR.  
 Discharge ball-valve: CW 617 N brass nickel plated.  
 Discharge plastic nipple: reinforced polypropylene.  
 Drain funnel: reinforced polypropylene.



**DRAIN FUNNEL**  
 Back-flow preventing device  
 UNI EN 1717-11/2002

### DP S DS MP with plastic rotational group and discharge valve

#### CLEAR BOWL HOUSING MODELS

CODE	MODEL	SUITABLE CARTRIDGE	IN/OUT	DIMENSIONS mm		
				A	B	C
RA1410431	DP S 10 DS MP 3/4" - 1" TS	10"	3/4" - 1"	481	172	170
RA1410531	DP S 20 DS MP 3/4" - 1" TS	20"	3/4" - 1"	730	172	170



### DP S DS MO with brass rotational group and discharge valve

#### CLEAR BOWL HOUSING MODELS

CODE	MODEL	SUITABLE CARTRIDGE	IN/OUT	DIMENSIONS mm		
				A	B	C
RA1410441	DP S 10 DS MO 3/4" TS	10"	3/4"	481	164	164
RA1410741	DP S 10 DS MO 1" TS	10"	1"	481	168	164
RA1410841	DP S 20 DS MO 3/4" TS	20"	3/4"	730	164	164
RA1410941	DP S 20 DS MO 1" TS	20"	1"	730	168	164



### VARIANTS AVAILABLE ON MINIMUM QUANTITY:

- RT housings suitable for filter cartridges with length 508 mm



# DP BIG

filter housings for BIG cartridges

Brand new range of Mono, Duo and Trio filter housings designed to fit "BIG" filter cartridges with outer diameter (OD) 4.50", inner diameter (ID) 1.10", height at 10" and 20"

# HOUSINGS DP BIG

FOR CARTRIDGES BIG SX

## Mono, Duo and Trio patented and registered models.

The all new, most comprehensive range of housings fit to 10" and 20" BIG filter cartridges with outer diameter 4,50", with standard SX (DOE) configuration.

A wide range of BIG filter cartridges melt-blown polypropylene, string wound, carbon block and brand new pleated media is available for the housing range.

DP BIG models are available as:

- **CLEAR housings** 10" and 20", with female in/out connections at 1" and 1 1/2" with BSP or NPT threads.
- **BLUE housings** 10" and 20", with female in/out connections at 1" and 1 1/2" with BSP or NPT threads.

All housings, clear and opaque, are also available as models with manometers and with discharge valve provided with drain funnel to protect drinking water from pollution by back-wash, in compliance with **UNI EN 1717-11/2002**.



**SX** cartridges  
with standard flat seals.

### ACCESSORIES INCLUDED



-DP BIG- spanner CODE RB7403019

### CERTIFICATIONS



Housings certified by IAPMO RT to NSF/ANSI 42, 61, 372 - lead free, CSA B483.1. In compliance with Drinking Water Treatment Units regulations, USA and Canada.



Housings are tested and certified under the most stringent procedures worldwide, in compliance with DM 25 (Italy), with the sanitary certification EAC/Ghostreghistracia (Russia) and WaterMark (Australia).

### SYMBOLS LEGEND



For domestic use



For technical and industrial use



Filter housings made in PET, a highly recyclable plastic, are manufactured with a proprietary procedure saving up to 60% of energy in injection molding compared with standard plastics. That is one of Atlas Filtri commitments to comply with Kyoto Treaty for the reduction of green house gas (CO<sub>2</sub>) emissions in the atmosphere.

### DISCHARGE KIT FOR -S- MODEL



brass discharge ball-valve with gasket



drain funnel



plastic hose-holder

In compliance with the European Standard UNI EN 1717/2002: designed to prevent back-flow contamination by making all elements downstream the discharge vent to atmosphere (protection unit symbol: DC)



-LUBRIKIT- single-dose lubricant for housing o-ring  
CODE RE9020650

### ACCESSORIES ON DEMAND



1" brass nipples  
with o-ring (pair)  
CODE RB7404002

-DP BIG MONO-  
wall bracket  
CODE RB7401040



-DP BIG DUO- wall bracket CODE RB7401043



-DP BIG TRIO- wall bracket CODE RB7401044



-KIT AUTO- for S models CODE RE7120024  
automatic discharge kit (see pages 186-187)



-KIT LEG 10- for DP BIG 10  
CODE RB7401051

-KIT LEG 20- for DP BIG 20  
CODE RB7401052

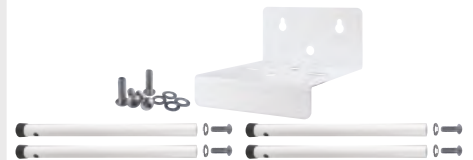

-KIT FRAME 10 MONO-  
for DP BIG 10 MONO  
CODE RB7401045

-KIT FRAME 20 MONO-  
for DP BIG 20 MONO  
CODE RB7401046



-KIT FRAME 10 DUO-  
for DP BIG 10 DUO  
CODE RB7401047

-KIT FRAME 20 DUO-  
for DP BIG 20 DUO  
CODE RB7401048



-KIT FRAME 10 TRIO-  
for DP BIG 10 TRIO  
CODE RB7401049

-KIT FRAME 20 TRIO-  
for DP BIG 20 TRIO  
CODE RB7401050



-VT- ground fixing kit CODE LB7221134







DP BIG		10	MONO	1"	IN	TS
HOUSINGS MODEL		HOUSINGS HEIGHT	VERSION	IN / OUT	THREADS TYPE	BOWL TYPE
DP BIG	DP BIG M		MONO	1"	IN - PLASTIC BSP*	TS - CLEAR (PET)
DP BIG S	DP BIG S M		DUO	1 1/2"	NPT IN - PLASTIC NPT**	AB - BLUE (PP)
DP BIG PS PM			TRIO			



MONO



DUO



TRIO

\* BSP parallel (cylindrical) ISO 228

\*\* NPT tapered (conical) ANSI/ASME B1.20.1





# DP BIG MONO

## WORKING CONDITIONS

Max working pressure \_\_\_\_\_ 8,3 bar (120 psi)  
 Max working temperature \_\_\_\_\_ 45°C (113°F)  
 Min working temperature \_\_\_\_\_ 4°C (39,2°F)

## SPECIFICATIONS

Non-toxic materials, suitable for drinking water.  
 Head: reinforced polypropylene.  
 Clear bowl: PET.  
 Blue bowl: reinforced polypropylene.  
 O-ring: EPDM.  
 Breather-valve: body polypropylene, o-ring EPDM.

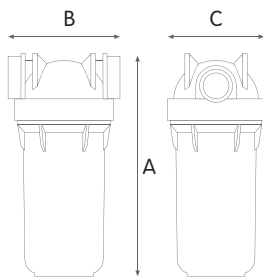

## DP BIG MONO clear housings

### HOUSINGS WITH PLASTIC BSP THREADS

CODE	MODEL	SUITABLE CARTRIDGE	IN/OUT	DIMENSIONS mm		
				A	B	C
RA1700711	DP BIG 10 MONO - 1" IN TS	10"	1"	360	190	185
RA1700911	DP BIG 10 MONO - 1"1/2 IN TS	10"	1"1/2	360	190	185
RA1800711	DP BIG 20 MONO - 1" IN TS	20"	1"	617	190	185
RA1800911	DP BIG 20 MONO - 1"1/2 IN TS	20"	1"1/2	617	190	185

### HOUSINGS WITH PLASTIC NPT THREADS

CODE	MODEL	SUITABLE CARTRIDGE	IN/OUT	DIMENSIONS mm		
				A	B	C
RA1700721	DP BIG 10 MONO - 1" NPT IN TS	10"	1"	360	190	185
RA1700921	DP BIG 10 MONO - 1"1/2 NPT IN TS	10"	1"1/2	360	190	185
RA1800721	DP BIG 20 MONO - 1" NPT IN TS	20"	1"	617	190	185
RA1800921	DP BIG 20 MONO - 1"1/2 NPT IN TS	20"	1"1/2	617	190	185

## DP BIG MONO blue housings

### HOUSINGS WITH PLASTIC BSP THREADS

CODE	MODEL	SUITABLE CARTRIDGE	IN/OUT	DIMENSIONS mm		
				A	B	C
RA1700712	DP BIG 10 MONO - 1" IN AB	10"	1"	360	190	185
RA1700912	DP BIG 10 MONO - 1"1/2 IN AB	10"	1"1/2	360	190	185
RA1800712	DP BIG 20 MONO - 1" IN AB	20"	1"	617	190	185
RA1800912	DP BIG 20 MONO - 1"1/2 IN AB	20"	1"1/2	617	190	185

### HOUSINGS WITH PLASTIC NPT THREADS

CODE	MODEL	SUITABLE CARTRIDGE	IN/OUT	DIMENSIONS mm		
				A	B	C
RA1700722	DP BIG 10 MONO - 1" NPT IN AB	10"	1"	360	190	185
RA1700922	DP BIG 10 MONO - 1"1/2 NPT IN AB	10"	1"1/2	360	190	185
RA1800722	DP BIG 20 MONO - 1" NPT IN AB	20"	1"	617	190	185
RA1800922	DP BIG 20 MONO - 1"1/2 NPT IN AB	20"	1"1/2	617	190	185





# DP BIG M MONO

## WORKING CONDITIONS

Max working pressure \_\_\_\_\_ 8,3 bar (120 psi)  
 Max working temperature \_\_\_\_\_ 45°C (113°F)  
 Min working temperature \_\_\_\_\_ 4°C (39,2°F)

## SPECIFICATIONS

Non-toxic materials, suitable for drinking water.  
 Head: reinforced polypropylene.  
 Clear bowl: PET.  
 Blue bowl: reinforced polypropylene.  
 O-ring: EPDM.  
 Breather-valve: body polypropylene, o-ring EPDM.  
 Manometers: radial type, pressure range 0-12 bar, 0-170 psi.

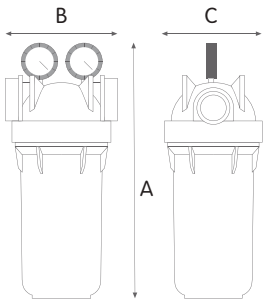

### DP BIG M MONO clear housings with 2 manometers

#### HOUSINGS WITH PLASTIC BSP THREADS

CODE	MODEL	SUITABLE CARTRIDGE	IN/OUT	DIMENSIONS mm		
				A	B	C
RA1700731	DP BIG M 10 MONO - 1" IN TS	10"	1"	425	190	185
RA1700931	DP BIG M 10 MONO - 1"1/2 IN TS	10"	1"1/2	425	190	185
RA1800731	DP BIG M 20 MONO - 1" IN TS	20"	1"	682	190	185
RA1800931	DP BIG M 20 MONO - 1"1/2 IN TS	20"	1"1/2	682	190	185

DP BIG FILTER HOUSINGS



### DP BIG M MONO blue housings with 2 manometers

#### HOUSINGS WITH PLASTIC BSP THREADS

CODE	MODEL	SUITABLE CARTRIDGE	IN/OUT	DIMENSIONS mm		
				A	B	C
RA1700732	DP BIG M 10 MONO - 1" IN AB	10"	1"	435	190	185
RA1700932	DP BIG M 10 MONO - 1"1/2 IN AB	10"	1"1/2	435	190	185
RA1800732	DP BIG M 20 MONO - 1" IN AB	20"	1"	682	190	185
RA1800932	DP BIG M 20 MONO - 1"1/2 IN AB	20"	1"1/2	682	190	185



# DP BIG S MONO

## WORKING CONDITIONS

Max working pressure \_\_\_\_\_ 8,3 bar (120 psi)  
 Max working temperature \_\_\_\_\_ 45°C (113°F)  
 Min working temperature \_\_\_\_\_ 4°C (39,2°F)

## SPECIFICATIONS

Non-toxic materials, suitable for drinking water.  
 Head: reinforced polypropylene.  
 Clear bowl: PET.  
 Blue bowl: reinforced polypropylene.  
 O-ring: EPDM.  
 Breather-valve: body polypropylene, o-ring EPDM.  
 Discharge ball-valve: CW 617 N brass nickel plated.  
 Drain funnel: reinforced polypropylene.

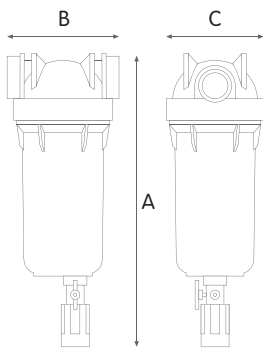

**DRAIN FUNNEL**  
 Back-flow preventing device  
 UNI EN 1717-11/2002

## DP BIG S MONO clear housings with discharge valve

### HOUSINGS WITH PLASTIC BSP THREADS

CODE	MODEL	SUITABLE CARTRIDGE	IN/OUT	DIMENSIONS mm		
				A	B	C
RA1700733	DP BIG S 10 MONO - 1" IN TS	10"	1"	480	190	185
RA1700933	DP BIG S 10 MONO - 1"1/2 IN TS	10"	1"1/2	480	190	185
RA1800733	DP BIG S 20 MONO - 1" IN TS	20"	1"	737	190	185
RA1800933	DP BIG S 20 MONO - 1"1/2 IN TS	20"	1"1/2	737	190	185



## DP BIG S MONO blue housings with discharge valve

### HOUSINGS WITH PLASTIC BSP THREADS

CODE	MODEL	SUITABLE CARTRIDGE	IN/OUT	DIMENSIONS mm		
				A	B	C
RA1700734	DP BIG S 10 MONO - 1" IN AB	10"	1"	480	190	185
RA1700934	DP BIG S 10 MONO - 1"1/2 IN AB	10"	1"1/2	480	190	185
RA1800734	DP BIG S 20 MONO - 1" IN AB	20"	1"	737	190	185
RA1800934	DP BIG S 20 MONO - 1"1/2 IN AB	20"	1"1/2	737	190	185





# DP BIG S M MONO

## WORKING CONDITIONS

Max working pressure \_\_\_\_\_ 8,3 bar (120 psi)  
 Max working temperature \_\_\_\_\_ 45°C (113°F)  
 Min working temperature \_\_\_\_\_ 4°C (39,2°F)

## SPECIFICATIONS

Non-toxic materials, suitable for drinking water.  
 Head: reinforced polypropylene.  
 Clear bowl: PET.  
 Blue bowl: reinforced polypropylene.  
 O-ring: EPDM.  
 Breather-valve: body polypropylene, o-ring EPDM.  
 Manometers: radial type, pressure range 0-12 bar, 0-170 psi.  
 Discharge ball-valve: CW 617 N brass nickel plated.  
 Drain funnel: reinforced polypropylene.

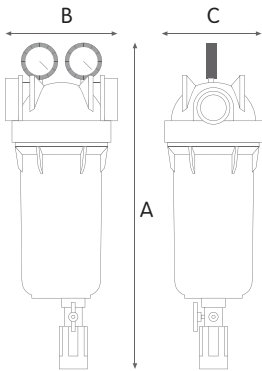

**DRAIN FUNNEL**  
 Back-flow preventing device  
 UNI EN 1717-11/2002

## DP BIG S M MONO clear housings with discharge valve and 2 manometers

### HOUSINGS WITH PLASTIC BSP THREADS

CODE	MODEL	SUITABLE CARTRIDGE	IN/OUT	DIMENSIONS mm		
				A	B	C
RA1700735	DP BIG S M 10 MONO - 1" IN TS	10"	1"	545	190	185
RA1700935	DP BIG S M 10 MONO - 1"1/2 IN TS	10"	1"1/2"	545	190	185
RA1800735	DP BIG S M 20 MONO - 1" IN TS	20"	1"	802	190	185
RA1800935	DP BIG S M 20 MONO - 1"1/2 IN TS	20"	1"1/2"	802	190	185



## DP BIG S M MONO blue housings with discharge valve and 2 manometers

### HOUSINGS WITH PLASTIC BSP THREADS

CODE	MODEL	SUITABLE CARTRIDGE	IN/OUT	DIMENSIONS mm		
				A	B	C
RA1700736	DP BIG S M 10 MONO - 1" IN AB	10"	1"	545	190	185
RA1700936	DP BIG S M 10 MONO - 1"1/2 IN AB	10"	1"1/2"	545	190	185
RA1800736	DP BIG S M 20 MONO - 1" IN AB	20"	1"	802	190	185
RA1800936	DP BIG S M 20 MONO - 1"1/2 IN AB	20"	1"1/2"	802	190	185



DP BIG FILTER HOUSINGS



# DP BIG PS PM MONO

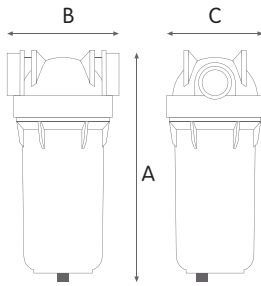

## WORKING CONDITIONS

Max working pressure \_\_\_\_\_ 8,3 bar (120 psi)  
 Max working temperature \_\_\_\_\_ 45°C (113°F)  
 Min working temperature \_\_\_\_\_ 4°C (39,2°F)

## SPECIFICATIONS

Non-toxic materials, suitable for drinking water.  
 Head: reinforced polypropylene.  
 Clear bowl: PET.  
 Blue bowl: reinforced polypropylene.  
 O-ring: EPDM.  
 Breather-valve: body polypropylene, o-ring EPDM.  
 Drain plug: nylon.  
 Manometer plug: CW 614 N brass.

DRAIN PLUG

MANOMETER PLUG



## DP BIG PS PM MONO clear housings with drain and manometer plugs

### HOUSINGS WITH PLASTIC BSP THREADS

CODE	MODEL	SUITABLE CARTRIDGE	IN/OUT	DIMENSIONS mm		
				A	B	C
RA1701735	DP BIG PS PM 10 MONO - 1" IN TS	10"	1"	390	190	185
RA1701935	DP BIG PS PM 10 MONO - 1"1/2 IN TS	10"	1"1/2	390	190	185
RA1801735	DP BIG PS PM 20 MONO - 1" IN TS	20"	1"	647	190	185
RA1801935	DP BIG PS PM 20 MONO - 1"1/2 IN TS	20"	1"1/2	647	190	185

### HOUSINGS WITH PLASTIC NPT THREADS

CODE	MODEL	SUITABLE CARTRIDGE	IN/OUT	DIMENSIONS mm		
				A	B	C
RA1701745	DP BIG PS PM 10 MONO - 1" NPT IN TS	10"	1"	390	190	185
RA1701945	DP BIG PS PM 10 MONO - 1"1/2 NPT IN TS	10"	1"1/2	390	190	185
RA1801745	DP BIG PS PM 20 MONO - 1" NPT IN TS	20"	1"	647	190	185
RA1801945	DP BIG PS PM 20 MONO - 1"1/2 NPT IN TS	20"	1"1/2	647	190	185



## DP BIG PS PM MONO blue housings with drain and manometer plugs

### HOUSINGS WITH PLASTIC BSP THREADS

CODE	MODEL	SUITABLE CARTRIDGE	IN/OUT	DIMENSIONS mm		
				A	B	C
RA1701736	DP BIG PS PM 10 MONO - 1" IN AB	10"	1"	390	190	185
RA1701936	DP BIG PS PM 10 MONO - 1"1/2 IN AB	10"	1"1/2	390	190	185
RA1801736	DP BIG PS PM 20 MONO - 1" IN AB	20"	1"	647	190	185
RA1801936	DP BIG PS PM 20 MONO - 1"1/2 IN AB	20"	1"1/2	647	190	185

### HOUSINGS WITH PLASTIC NPT THREADS

CODE	MODEL	SUITABLE CARTRIDGE	IN/OUT	DIMENSIONS mm		
				A	B	C
RA1701746	DP BIG PS PM 10 MONO - 1" NPT IN AB	10"	1"	390	190	185
RA1701946	DP BIG PS PM 10 MONO - 1"1/2 NPT IN AB	10"	1"1/2	390	190	185
RA1801746	DP BIG PS PM 20 MONO - 1" NPT IN AB	20"	1"	647	190	185
RA1801946	DP BIG PS PM 20 MONO - 1"1/2 NPT IN AB	20"	1"1/2	647	190	185





# DP BIG DUO

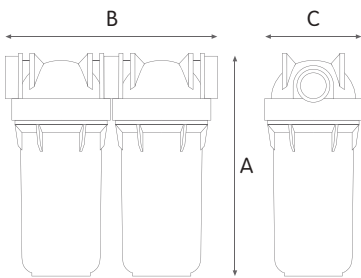

## WORKING CONDITIONS

Max working pressure \_\_\_\_\_ 8,3 bar (120 psi)  
 Max working temperature \_\_\_\_\_ 45°C (113°F)  
 Min working temperature \_\_\_\_\_ 4°C (39,2°F)

## SPECIFICATIONS

Non-toxic materials, suitable for drinking water.  
 Head: reinforced polypropylene.  
 Clear bowl: PET.  
 Blue bowl: reinforced polypropylene.  
 O-ring: EPDM.  
 Breather-valve: body polypropylene, o-ring EPDM.



## DP BIG DUO clear housings

### HOUSINGS WITH PLASTIC BSP THREADS

CODE	MODEL	SUITABLE CARTRIDGE	IN/OUT	DIMENSIONS mm		
				A	B	C
RA1702711	DP BIG 10 DUO - 1" IN TS	10"	1"	375	390	185
RA1702911	DP BIG 10 DUO - 1"1/2 IN TS	10"	1"1/2	375	390	185
RA1802711	DP BIG 20 DUO - 1" IN TS	20"	1"	640	390	185
RA1802911	DP BIG 20 DUO - 1"1/2 IN TS	20"	1"1/2	640	390	185

### HOUSINGS WITH PLASTIC NPT THREADS

CODE	MODEL	SUITABLE CARTRIDGE	IN/OUT	DIMENSIONS mm		
				A	B	C
RA1702721	DP BIG 10 DUO - 1" NPT IN TS	10"	1"	375	390	185
RA1702921	DP BIG 10 DUO - 1"1/2 NPT IN TS	10"	1"1/2	375	390	185
RA1802721	DP BIG 20 DUO - 1" NPT IN TS	20"	1"	640	390	185
RA1802921	DP BIG 20 DUO - 1"1/2 NPT IN TS	20"	1"1/2	640	390	185



## DP BIG DUO blue housings

### HOUSINGS WITH PLASTIC BSP THREADS

CODE	MODEL	SUITABLE CARTRIDGE	IN/OUT	DIMENSIONS mm		
				A	B	C
RA1702712	DP BIG 10 DUO - 1" IN AB	10"	1"	375	390	185
RA1702912	DP BIG 10 DUO - 1"1/2 IN AB	10"	1"1/2	375	390	185
RA1802712	DP BIG 20 DUO - 1" IN AB	20"	1"	640	390	185
RA1802912	DP BIG 20 DUO - 1"1/2 IN AB	20"	1"1/2	640	390	185

### HOUSINGS WITH PLASTIC NPT THREADS

CODE	MODEL	SUITABLE CARTRIDGE	IN/OUT	DIMENSIONS mm		
				A	B	C
RA1702722	DP BIG 10 DUO - 1" NPT IN AB	10"	1"	375	390	185
RA1702922	DP BIG 10 DUO - 1"1/2 NPT IN AB	10"	1"1/2	375	390	185
RA1802722	DP BIG 20 DUO - 1" NPT IN AB	20"	1"	640	390	185
RA1802922	DP BIG 20 DUO - 1"1/2 NPT IN AB	20"	1"1/2	640	390	185

DP BIG FILTER HOUSINGS





# DP BIG M DUO

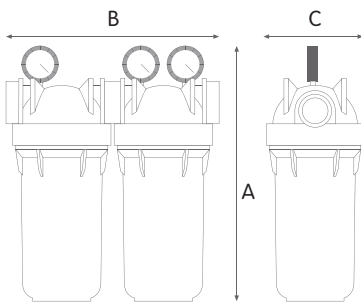

## WORKING CONDITIONS

Max working pressure \_\_\_\_\_ 8,3 bar (120 psi)  
 Max working temperature \_\_\_\_\_ 45°C (113°F)  
 Min working temperature \_\_\_\_\_ 4°C (39,2°F)

## SPECIFICATIONS

Non-toxic materials, suitable for drinking water.  
 Head: reinforced polypropylene.  
 Clear bowl: PET.  
 Blue bowl: reinforced polypropylene.  
 O-ring: EPDM.  
 Breather-valve: body polypropylene, o-ring EPDM.  
 Manometers: radial type, pressure range 0-12 bar, 0-170 psi.

## DP BIG M DUO clear housings with 3 manometers



### HOUSINGS WITH PLASTIC BSP THREADS

CODE	MODEL	SUITABLE CARTRIDGE	IN/OUT	DIMENSIONS mm		
				A	B	C
RA1702731	DP BIG M 10 DUO - 1" IN TS	10"	1"	440	390	185
RA1702931	DP BIG M 10 DUO - 1"1/2 IN TS	10"	1"1/2	440	390	185
RA1802731	DP BIG M 20 DUO - 1" IN TS	20"	1"	705	390	185
RA1802931	DP BIG M 20 DUO - 1"1/2 IN TS	20"	1"1/2	705	390	185

## DP BIG M DUO blue housings with 3 manometers



### HOUSINGS WITH PLASTIC BSP THREADS

CODE	MODEL	SUITABLE CARTRIDGE	IN/OUT	DIMENSIONS mm		
				A	B	C
RA1702732	DP BIG M 10 DUO - 1" IN AB	10"	1"	440	390	185
RA1702932	DP BIG M 10 DUO - 1"1/2 IN AB	10"	1"1/2	440	390	185
RA1802732	DP BIG M 20 DUO - 1" IN AB	20"	1"	705	390	185
RA1802932	DP BIG M 20 DUO - 1"1/2 IN AB	20"	1"1/2	705	390	185



# DP BIG S DUO

## WORKING CONDITIONS

Max working pressure \_\_\_\_\_ 8,3 bar (120 psi)  
 Max working temperature \_\_\_\_\_ 45°C (113°F)  
 Min working temperature \_\_\_\_\_ 4°C (39,2°F)

## SPECIFICATIONS

Non-toxic materials, suitable for drinking water.  
 Head: reinforced polypropylene.  
 Clear bowl: PET.  
 Blue bowl: reinforced polypropylene.  
 O-ring: EPDM.  
 Breather-valve: body polypropylene, o-ring EPDM.  
 Discharge ball-valve: CW 617 N brass nickel plated.  
 Drain funnel: reinforced polypropylene.

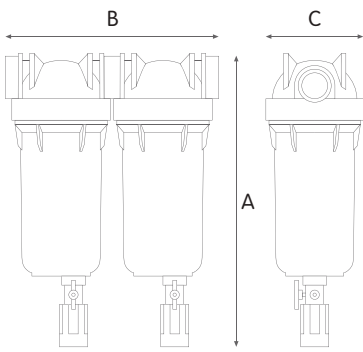

**DRAIN FUNNEL**  
 Back-flow preventing device  
 UNI EN 1717-11/2002

## DP BIG S DUO clear housings with discharge valves

### HOUSINGS WITH PLASTIC BSP THREADS

CODE	MODEL	SUITABLE CARTRIDGE	IN/OUT	DIMENSIONS mm		
				A	B	C
RA1702733	DP BIG S 10 DUO - 1" IN TS	10"	1"	495	390	185
RA1702933	DP BIG S 10 DUO - 1"1/2 IN TS	10"	1"1/2	495	390	185
RA1802733	DP BIG S 20 DUO - 1" IN TS	20"	1"	760	390	185
RA1802933	DP BIG S 20 DUO - 1"1/2 IN TS	20"	1"1/2	760	390	185



## DP BIG S DUO blue housings with discharge valves

### HOUSINGS WITH PLASTIC BSP THREADS

CODE	MODEL	SUITABLE CARTRIDGE	IN/OUT	DIMENSIONS mm		
				A	B	C
RA1702734	DP BIG S 10 DUO - 1" IN AB	10"	1"	495	390	185
RA1702934	DP BIG S 10 DUO - 1"1/2 IN AB	10"	1"1/2	495	390	185
RA1802734	DP BIG S 20 DUO - 1" IN AB	20"	1"	760	390	185
RA1802934	DP BIG S 20 DUO - 1"1/2 IN AB	20"	1"1/2	760	390	185



DP BIG FILTER HOUSINGS



# DP BIG S M DUO

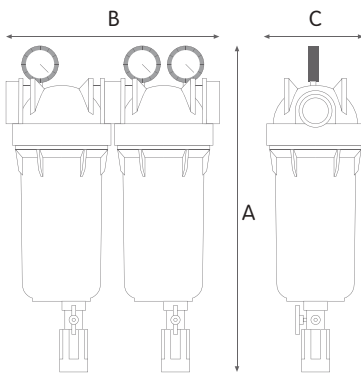

## WORKING CONDITIONS

Max working pressure \_\_\_\_\_ 8,3 bar (120 psi)  
 Max working temperature \_\_\_\_\_ 45°C (113°F)  
 Min working temperature \_\_\_\_\_ 4°C (39,2°F)

## SPECIFICATIONS

Non-toxic materials, suitable for drinking water.  
 Head: reinforced polypropylene.  
 Clear bowl: PET.  
 Blue bowl: reinforced polypropylene.  
 O-ring: EPDM.  
 Breather-valve: body polypropylene, o-ring EPDM.  
 Manometers: radial type, pressure range 0-12 bar, 0-170 psi.  
 Discharge ball-valve: CW 617 N brass nickel plated.  
 Drain funnel: reinforced polypropylene.



**DRAIN FUNNEL**  
 Back-flow preventing device  
 UNI EN 1717-11/2002

## DP BIG S M DUO clear housings with discharge valves and 3 manometers



### HOUSINGS WITH PLASTIC BSP THREADS

CODE	MODEL	SUITABLE CARTRIDGE	IN/OUT	DIMENSIONS mm		
				A	B	C
RA1702735	DP BIG S M 10 DUO - 1" IN TS	10"	1"	560	390	185
RA1702935	DP BIG S M 10 DUO - 1"1/2 IN TS	10"	1"1/2	560	390	185
RA1802735	DP BIG S M 20 DUO - 1" IN TS	20"	1"	825	390	185
RA1802935	DP BIG S M 20 DUO - 1"1/2 IN TS	20"	1"1/2	825	390	185

## DP BIG S M DUO blue housings with discharge valves and 3 manometers



### HOUSINGS WITH PLASTIC BSP THREADS

CODE	MODEL	SUITABLE CARTRIDGE	IN/OUT	DIMENSIONS mm		
				A	B	C
RA1702736	DP BIG S M 10 DUO - 1" IN AB	10"	1"	560	390	185
RA1702936	DP BIG S M 10 DUO - 1"1/2 IN AB	10"	1"1/2	560	390	185
RA1802736	DP BIG S M 20 DUO - 1" IN AB	20"	1"	825	390	185
RA1802936	DP BIG S M 20 DUO - 1"1/2 IN AB	20"	1"1/2	825	390	185



# DP BIG PS PM DUO

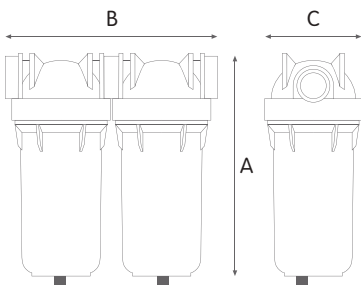

## WORKING CONDITIONS

Max working pressure \_\_\_\_\_ 8,3 bar (120 psi)  
 Max working temperature \_\_\_\_\_ 45°C (113°F)  
 Min working temperature \_\_\_\_\_ 4°C (39,2°F)

## SPECIFICATIONS

Non-toxic materials, suitable for drinking water.  
 Head: reinforced polypropylene.  
 Clear bowl: PET.  
 Blue bowl: reinforced polypropylene.  
 O-ring: EPDM.  
 Breather-valve: body polypropylene, o-ring EPDM.  
 Drain plug: nylon.  
 Manometer plug: CW 614 N brass.

DRAIN PLUG

MANOMETER PLUG



## DP BIG PS PM DUO clear housings with drain and manometer plugs

### HOUSINGS WITH PLASTIC BSP THREADS

CODE	MODEL	SUITABLE CARTRIDGE	IN/OUT	DIMENSIONS mm		
				A	B	C
RA1702765	DP BIG PS PM 10 DUO - 1" IN TS	10"	1"	405	390	185
RA1702965	DP BIG PS PM 10 DUO - 1"1/2 IN TS	10"	1"1/2	405	390	185
RA1802765	DP BIG PS PM 20 DUO - 1" IN TS	20"	1"	670	390	185
RA1802965	DP BIG PS PM 20 DUO - 1"1/2 IN TS	20"	1"1/2	670	390	185

### HOUSINGS WITH PLASTIC NPT THREADS

CODE	MODEL	SUITABLE CARTRIDGE	IN/OUT	DIMENSIONS mm		
				A	B	C
RA1702755	DP BIG PS PM 10 DUO - 1" NPT IN TS	10"	1"	405	390	185
RA1702955	DP BIG PS PM 10 DUO - 1"1/2 NPT IN TS	10"	1"1/2	405	390	185
RA1802755	DP BIG PS PM 20 DUO - 1" NPT IN TS	20"	1"	670	390	185
RA1802955	DP BIG PS PM 20 DUO - 1"1/2 NPT IN TS	20"	1"1/2	670	390	185



## DP BIG PS PM DUO blue housings with drain and manometer plugs

### HOUSINGS WITH PLASTIC BSP THREADS

CODE	MODEL	SUITABLE CARTRIDGE	IN/OUT	DIMENSIONS mm		
				A	B	C
RA1702766	DP BIG PS PM 10 DUO - 1" IN AB	10"	1"	405	390	185
RA1702966	DP BIG PS PM 10 DUO - 1"1/2 IN AB	10"	1"1/2	405	390	185
RA1802766	DP BIG PS PM 20 DUO - 1" IN AB	20"	1"	670	390	185
RA1802966	DP BIG PS PM 20 DUO - 1"1/2 IN AB	20"	1"1/2	670	390	185

### HOUSINGS WITH PLASTIC NPT THREADS

CODE	MODEL	SUITABLE CARTRIDGE	IN/OUT	DIMENSIONS mm		
				A	B	C
RA1702756	DP BIG PS PM 10 DUO - 1" NPT IN AB	10"	1"	405	390	185
RA1702956	DP BIG PS PM 10 DUO - 1"1/2 NPT IN AB	10"	1"1/2	405	390	185
RA1802756	DP BIG PS PM 20 DUO - 1" NPT IN AB	20"	1"	670	390	185
RA1802956	DP BIG PS PM 20 DUO - 1"1/2 NPT IN AB	20"	1"1/2	670	390	185





# DP BIG TRIO

## WORKING CONDITIONS

Max working pressure \_\_\_\_\_ 8,3 bar (120 psi)  
 Max working temperature \_\_\_\_\_ 45°C (113°F)  
 Min working temperature \_\_\_\_\_ 4°C (39,2°F)

## SPECIFICATIONS

Non-toxic materials, suitable for drinking water.  
 Head: reinforced polypropylene.  
 Clear bowl: PET.  
 Blue bowl: reinforced polypropylene.  
 O-ring: EPDM.  
 Breather-valve: body polypropylene, o-ring EPDM.

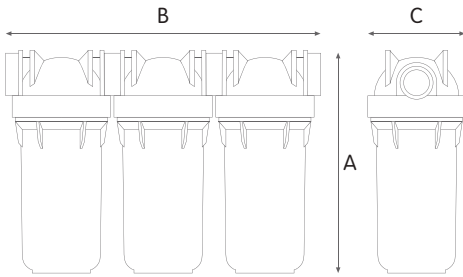

## DP BIG TRIO clear housings

### HOUSINGS WITH PLASTIC BSP THREADS

CODE	MODEL	SUITABLE CARTRIDGE	IN/OUT	DIMENSIONS mm		
				A	B	C
RA1703711	DP BIG 10 TRIO - 1" IN TS	10"	1"	375	590	185
RA1703911	DP BIG 10 TRIO - 1"1/2 IN TS	10"	1"1/2	375	590	185
RA1803711	DP BIG 20 TRIO - 1" IN TS	20"	1"	640	590	185
RA1803911	DP BIG 20 TRIO - 1"1/2 IN TS	20"	1"1/2	640	590	185

### HOUSINGS WITH PLASTIC NPT THREADS

CODE	MODEL	SUITABLE CARTRIDGE	IN/OUT	DIMENSIONS mm		
				A	B	C
RA1703721	DP BIG 10 TRIO - 1" NPT IN TS	10"	1"	375	590	185
RA1703921	DP BIG 10 TRIO - 1"1/2 NPT IN TS	10"	1"1/2	375	590	185
RA1803721	DP BIG 20 TRIO - 1" NPT IN TS	20"	1"	640	590	185
RA1803921	DP BIG 20 TRIO - 1"1/2 NPT IN TS	20"	1"1/2	640	590	185

## DP BIG TRIO blue housings

### HOUSINGS WITH PLASTIC BSP THREADS

CODE	MODEL	SUITABLE CARTRIDGE	IN/OUT	DIMENSIONS mm		
				A	B	C
RA1703712	DP BIG 10 TRIO - 1" IN AB	10"	1"	375	590	185
RA1703912	DP BIG 10 TRIO - 1"1/2 IN AB	10"	1"1/2	375	590	185
RA1803712	DP BIG 20 TRIO - 1" IN AB	20"	1"	640	590	185
RA1803912	DP BIG 20 TRIO - 1"1/2 IN AB	20"	1"1/2	640	590	185

### HOUSINGS WITH PLASTIC NPT THREADS

CODE	MODEL	SUITABLE CARTRIDGE	IN/OUT	DIMENSIONS mm		
				A	B	C
RA1703722	DP BIG 10 TRIO - 1" NPT IN AB	10"	1"	375	590	185
RA1703922	DP BIG 10 TRIO - 1"1/2 NPT IN AB	10"	1"1/2	375	590	185
RA1803722	DP BIG 20 TRIO - 1" NPT IN AB	20"	1"	640	590	185
RA1803922	DP BIG 20 TRIO - 1"1/2 NPT IN AB	20"	1"1/2	640	590	185





# DP BIG M TRIO

## WORKING CONDITIONS

Max working pressure \_\_\_\_\_ 8,3 bar (120 psi)  
 Max working temperature \_\_\_\_\_ 45°C (113°F)  
 Min working temperature \_\_\_\_\_ 4°C (39,2°F)

## SPECIFICATIONS

Non-toxic materials, suitable for drinking water.  
 Head: reinforced polypropylene.  
 Clear bowl: PET.  
 Blue bowl: reinforced polypropylene.  
 O-ring: EPDM.  
 Breather-valve: body polypropylene, o-ring EPDM.  
 Manometers: radial type, pressure range 0-12 bar, 0-170 psi.

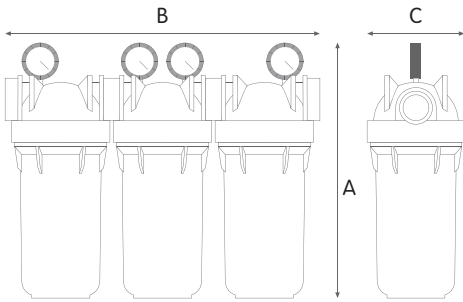

## DP BIG M TRIO clear housings with 4 manometers

### HOUSINGS WITH PLASTIC BSP THREADS

CODE	MODEL	SUITABLE CARTRIDGE	IN/OUT	DIMENSIONS mm		
				A	B	C
RA1703731	DP BIG M 10 TRIO - 1" IN TS	10"	1"	440	590	185
RA1703931	DP BIG M 10 TRIO - 1 1/2 IN TS	10"	1 1/2"	440	590	185
RA1803731	DP BIG M 20 TRIO - 1" IN TS	20"	1"	705	590	185
RA1803931	DP BIG M 20 TRIO - 1 1/2 IN TS	20"	1 1/2"	705	590	185



## DP BIG M TRIO blue housings with 4 manometers

### HOUSINGS WITH PLASTIC BSP THREADS

CODE	MODEL	SUITABLE CARTRIDGE	IN/OUT	DIMENSIONS mm		
				A	B	C
RA1703732	DP BIG M 10 TRIO - 1" IN AB	10"	1"	440	590	185
RA1703932	DP BIG M 10 TRIO - 1 1/2 IN AB	10"	1 1/2"	440	590	185
RA1803732	DP BIG M 20 TRIO - 1" IN AB	20"	1"	705	590	185
RA1803932	DP BIG M 20 TRIO - 1 1/2 IN AB	20"	1 1/2"	705	590	185



DP BIG FILTER HOUSINGS





# DP BIG S TRIO

## WORKING CONDITIONS

Max working pressure \_\_\_\_\_ 8,3 bar (120 psi)  
 Max working temperature \_\_\_\_\_ 45°C (113°F)  
 Min working temperature \_\_\_\_\_ 4°C (39,2°F)

## SPECIFICATIONS

Non-toxic materials, suitable for drinking water.  
 Head: reinforced polypropylene.  
 Clear bowl: PET.  
 Blue bowl: reinforced polypropylene.  
 O-ring: EPDM.  
 Breather-valve: body polypropylene, o-ring EPDM.  
 Discharge ball-valve: CW 617 N brass nickel plated.  
 Drain funnel: reinforced polypropylene.

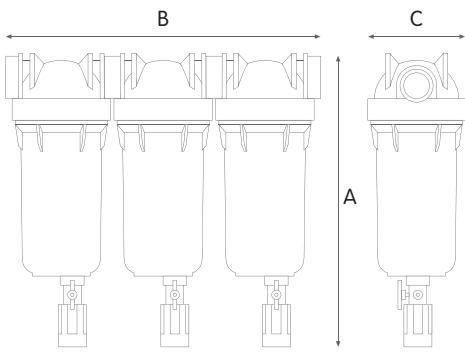

**DRAIN FUNNEL**  
 Back-flow preventing device  
 UNI EN 1717-11/2002

## DP BIG S TRIO clear housings with discharge valves

### HOUSINGS WITH PLASTIC BSP THREADS

CODE	MODEL	SUITABLE CARTRIDGE	IN/OUT	DIMENSIONS mm		
				A	B	C
RA1703733	DP BIG S 10 TRIO - 1" IN TS	10"	1"	495	590	185
RA1703933	DP BIG S 10 TRIO - 1"1/2 IN TS	10"	1"1/2	495	590	185
RA1803733	DP BIG S 20 TRIO - 1" IN TS	20"	1"	760	590	185
RA1803933	DP BIG S 20 TRIO - 1"1/2 IN TS	20"	1"1/2	760	590	185



## DP BIG S TRIO blue housings with discharge valves

### HOUSINGS WITH PLASTIC BSP THREADS

CODE	MODEL	SUITABLE CARTRIDGE	IN/OUT	DIMENSIONS mm		
				A	B	C
RA1703734	DP BIG S 10 TRIO - 1" IN AB	10"	1"	495	590	185
RA1703934	DP BIG S 10 TRIO - 1"1/2 IN AB	10"	1"1/2	495	590	185
RA1803734	DP BIG S 20 TRIO - 1" IN AB	20"	1"	760	590	185
RA1803934	DP BIG S 20 TRIO - 1"1/2 IN AB	20"	1"1/2	760	590	185





# DP BIG S M TRIO

## WORKING CONDITIONS

Max working pressure \_\_\_\_\_ 8,3 bar (120 psi)  
 Max working temperature \_\_\_\_\_ 45°C (113°F)  
 Min working temperature \_\_\_\_\_ 4°C (39,2°F)

## SPECIFICATIONS

Non-toxic materials, suitable for drinking water.  
 Head: reinforced polypropylene.  
 Clear bowl: PET.  
 Blue bowl: reinforced polypropylene.  
 O-ring: EPDM.  
 Breather-valve: body polypropylene, o-ring EPDM.  
 Manometers: radial type, pressure range 0-12 bar, 0-170 psi.  
 Discharge ball-valve: CW 617 N brass nickel plated.  
 Drain funnel: reinforced polypropylene.



**DRAIN FUNNEL**  
 Back-flow preventing device  
 UNI EN 1717-11/2002

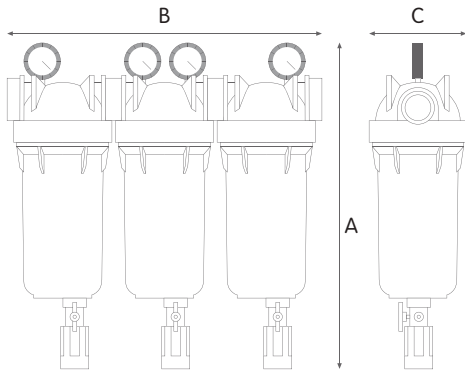

## DP BIG S M TRIO clear housings with discharge valves and 4 manometers

### HOUSINGS WITH PLASTIC BSP THREADS

CODE	MODEL	SUITABLE CARTRIDGE	IN/OUT	DIMENSIONS mm		
				A	B	C
RA1703735	DP BIG S M 10 TRIO - 1" IN TS	10"	1"	560	590	185
RA1703935	DP BIG S M 10 TRIO - 1"1/2 IN TS	10"	1"1/2"	560	590	185
RA1803735	DP BIG S M 20 TRIO - 1" IN TS	20"	1"	825	590	185
RA1803935	DP BIG S M 20 TRIO - 1"1/2 IN TS	20"	1"1/2"	825	590	185



## DP BIG S M TRIO blue housings with discharge valves and 4 manometers

### HOUSINGS WITH PLASTIC BSP THREADS

CODE	MODEL	SUITABLE CARTRIDGE	IN/OUT	DIMENSIONS mm		
				A	B	C
RA1703736	DP BIG S M 10 TRIO - 1" IN AB	10"	1"	560	590	185
RA1703936	DP BIG S M 10 TRIO - 1"1/2 IN AB	10"	1"1/2"	560	590	185
RA1803736	DP BIG S M 20 TRIO - 1" IN AB	20"	1"	825	590	185
RA1803936	DP BIG S M 20 TRIO - 1"1/2 IN AB	20"	1"1/2"	825	590	185



DP BIG FILTER HOUSINGS



# DP BIG PS PM TRIO

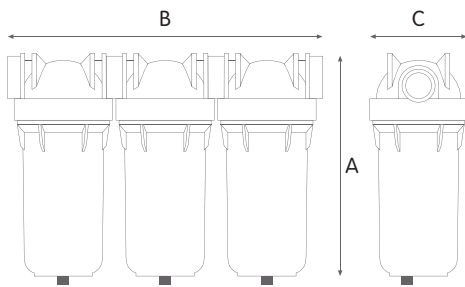

## WORKING CONDITIONS

Max working pressure \_\_\_\_\_ 8,3 bar (120 psi)  
 Max working temperature \_\_\_\_\_ 45°C (113°F)  
 Min working temperature \_\_\_\_\_ 4°C (39,2°F)

## SPECIFICATIONS

Non-toxic materials, suitable for drinking water.  
 Head: reinforced polypropylene.  
 Clear bowl: PET.  
 Blue bowl: reinforced polypropylene.  
 O-ring: EPDM.  
 Breather-valve: body polypropylene, o-ring EPDM.  
 Drain plug: nylon.  
 Manometer plug: CW 614 N brass.

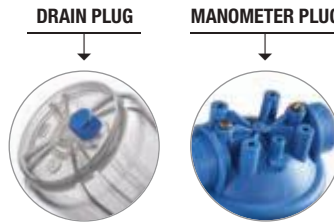

## DP BIG PS PM TRIO clear housings with drain and manometer plugs

### HOUSINGS WITH PLASTIC BSP THREADS

CODE	MODEL	SUITABLE CARTRIDGE	IN/OUT	DIMENSIONS mm		
				A	B	C
RA1703765	DP BIG PS PM 10 TRIO - 1" IN TS	10"	1"	405	590	185
RA1703965	DP BIG PS PM 10 TRIO - 1"1/2 IN TS	10"	1"1/2	405	590	185
RA1803765	DP BIG PS PM 20 TRIO - 1" IN TS	20"	1"	670	590	185
RA1803965	DP BIG PS PM 20 TRIO - 1"1/2 IN TS	20"	1"1/2	670	590	185

### HOUSINGS WITH PLASTIC NPT THREADS

CODE	MODEL	SUITABLE CARTRIDGE	IN/OUT	DIMENSIONS mm		
				A	B	C
RA1703755	DP BIG PS PM 10 TRIO - 1" NPT IN TS	10"	1"	405	590	185
RA1703955	DP BIG PS PM 10 TRIO - 1"1/2 NPT IN TS	10"	1"1/2	405	590	185
RA1803755	DP BIG PS PM 20 TRIO - 1" NPT IN TS	20"	1"	670	590	185
RA1803955	DP BIG PS PM 20 TRIO - 1"1/2 NPT IN TS	20"	1"1/2	670	590	185



## DP BIG PS PM TRIO blue housings with drain and manometer plugs

### HOUSINGS WITH PLASTIC BSP THREADS

CODE	MODEL	SUITABLE CARTRIDGE	IN/OUT	DIMENSIONS mm		
				A	B	C
RA1703766	DP BIG PS PM 10 TRIO - 1" IN AB	10"	1"	405	590	185
RA1703966	DP BIG PS PM 10 TRIO - 1"1/2 IN AB	10"	1"1/2	405	590	185
RA1803766	DP BIG PS PM 20 TRIO - 1" IN AB	20"	1"	670	590	185
RA1803966	DP BIG PS PM 20 TRIO - 1"1/2 IN AB	20"	1"1/2	670	590	185

### HOUSINGS WITH PLASTIC NPT THREADS

CODE	MODEL	SUITABLE CARTRIDGE	IN/OUT	DIMENSIONS mm		
				A	B	C
RA1703756	DP BIG PS PM 10 TRIO - 1" NPT IN AB	10"	1"	405	590	185
RA1703956	DP BIG PS PM 10 TRIO - 1"1/2 NPT IN AB	10"	1"1/2	405	590	185
RA1803756	DP BIG PS PM 20 TRIO - 1" NPT IN AB	20"	1"	670	590	185
RA1803956	DP BIG PS PM 20 TRIO - 1"1/2 NPT IN AB	20"	1"1/2	670	590	185





## DP BIG F

filter housings  
with metal frame kit

Brand new range of patented  
Mono, Duo and Trio  
manifold filter housings  
for filter cartridges with outer diameter  
(OD) 4.50", heights 10" and 20".

# HOUSINGS DP BIG F

WITH METAL FRAME FOR CARTRIDGES BIG SX

**Mono, Duo and Trio patented and registered models. Equipped with metal frame kit.**

The range of housings fit to 10" and 20" BIG filter cartridges with outer diameter 4,50", with standard SX (DOE) configuration.

**ADVANTAGES:**

- Single, double and triple patented filter housings with manifold heads for the highest safety and convenience.
- All steel Frame (legs and bracket) zinc plated and paint finished for high protection against corrosion and rust, provided in practical mounting kit.
- Extreme flexibility and easy to mount.
- **Prepared for ground fixing.**
- **Prepared for wall mounting.**
- Ports for installation of manometers (gauge plugs) and drain (drain plug).
- Reduced packing size, cost-effective logistic optimization.



**SX** cartridges with standard flat seals.

Wide range of dedicated 4.50" OD filter cartridges 10" and 20".

DP BIG filter housings in the frame models are available as:

- **CLEAR housings** 10" and 20", with female in/out connections at 1" and 1 1/2" with BSP or NPT threads.
- **BLUE housings** 10" and 20", with female in/out connections at 1" and 1 1/2" with BSP or NPT threads.



ACCESSORIES ON DEMAND



**ACCESSORIES INCLUDED**



**HOUSING CERTIFICATIONS**



Housings certified by IAPMO RT to NSF/ANSI 42, 61, 372 - lead free, CSA B483.1. In compliance with Drinking Water Treatment Units regulations, USA and Canada.



Housings are tested and certified under the most stringent procedures worldwide, in compliance with DM 25 (Italy), with the sanitary certification EAC/Ghostreghistrazia (Russia) and WaterMark (Australia).





**DP BIG F PS PM**   **10**   **MONO**   **1"**   **IN**   **TS**

**HOUSINGS MODEL**   **HOUSINGS HEIGHT**   **VERSION**   **IN / OUT**   **THREADS TYPE**   **BOWL TYPE**

PS - DRAIN PLUG   PM - MANOMETER PLUGS



MONO



DUO



TRIO



1"   1 1/2"

IN - PLASTIC BSP\*



NPT IN - PLASTIC NPT\*\*



TS - CLEAR (PET)



AB - BLUE (PP)



**SYMBOLS LEGEND**



For domestic use



For technical and industrial use



Filter housings made in PET, a highly recyclable plastic, are manufactured with a proprietary procedure saving up to 60% of energy in injection molding compared with standard plastics. That is one of Atlas Filtri commitments to comply with Kyoto Treaty for the reduction of green house gas (CO<sub>2</sub>) emissions in the atmosphere.

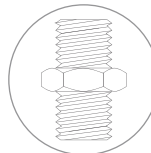

\* **BSP**  
parallel (cylindrical)  
ISO 228

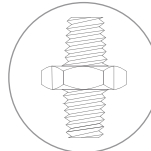

\*\* **NPT**  
tapered (conical)  
ANSI/ASME B1.20.1





# DP BIG F PS PM MONO

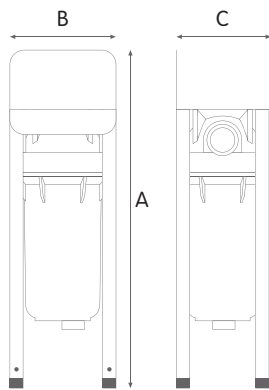

## WORKING CONDITIONS

Max working pressure \_\_\_\_\_ 8,3 bar (120 psi)  
 Max working temperature \_\_\_\_\_ 45°C (113°F)  
 Min working temperature \_\_\_\_\_ 4°C (39,2°F)

## SPECIFICATIONS

Non-toxic materials, suitable for drinking water.  
 Head: reinforced polypropylene.  
 Clear bowl: PET.  
 Blue bowl: reinforced polypropylene.  
 O-ring: EPDM.  
 Breather-valve: body polypropylene, o-ring EPDM.  
 Drain plug: reinforced nylon.  
 Gauge plug: CW 614 N brass.  
 Metal frame: varnished galvanized steel.

### DRAIN PLUG

### GAUGE PLUG



## DP BIG F PS PM MONO clear housings

### HOUSINGS WITH PLASTIC BSP THREADS

CODE	MODEL	SUITABLE CARTRIDGE	IN/OUT	DIMENSIONS mm		
				A	B	C
RA17F0711	DP BIG F PS PM 10 MONO - 1" IN TS	10"	1"	555	190	200
RA17F0911	DP BIG F PS PM 10 MONO - 1"1/2 IN TS	10"	1"1/2	555	190	200
RA18F0711	DP BIG F PS PM 20 MONO - 1" IN TS	20"	1"	805	190	200
RA18F0911	DP BIG F PS PM 20 MONO - 1"1/2 IN TS	20"	1"1/2	805	190	200

### HOUSINGS WITH PLASTIC NPT THREADS

CODE	MODEL	SUITABLE CARTRIDGE	IN/OUT	DIMENSIONS mm		
				A	B	C
RA17F0721	DP BIG F PS PM 10 MONO - 1" NPT IN TS	10"	1"	555	190	200
RA17F0921	DP BIG F PS PM 10 MONO - 1"1/2 NPT IN TS	10"	1"1/2	555	190	200
RA18F0721	DP BIG F PS PM 20 MONO - 1" NPT IN TS	20"	1"	805	190	200
RA18F0921	DP BIG F PS PM 20 MONO - 1"1/2 NPT IN TS	20"	1"1/2	805	190	200



## DP BIG F PS PM MONO blue housings

### HOUSINGS WITH PLASTIC BSP THREADS

CODE	MODEL	SUITABLE CARTRIDGE	IN/OUT	DIMENSIONS mm		
				A	B	C
RA17F0712	DP BIG F PS PM 10 MONO - 1" IN AB	10"	1"	555	190	200
RA17F0912	DP BIG F PS PM 10 MONO - 1"1/2 IN AB	10"	1"1/2	555	190	200
RA18F0712	DP BIG F PS PM 20 MONO - 1" IN AB	20"	1"	805	190	200
RA18F0912	DP BIG F PS PM 20 MONO - 1"1/2 IN AB	20"	1"1/2	805	190	200

### HOUSINGS WITH PLASTIC NPT THREADS

CODE	MODEL	SUITABLE CARTRIDGE	IN/OUT	DIMENSIONS mm		
				A	B	C
RA17F0722	DP BIG F PS PM 10 MONO - 1" NPT IN AB	10"	1"	555	190	200
RA17F0922	DP BIG F PS PM 10 MONO - 1"1/2 NPT IN AB	10"	1"1/2	555	190	200
RA18F0722	DP BIG F PS PM 20 MONO - 1" NPT IN AB	20"	1"	805	190	200
RA18F0922	DP BIG F PS PM 20 MONO - 1"1/2 NPT IN AB	20"	1"1/2	805	190	200





# DP BIG F DUO

## WORKING CONDITIONS

Max working pressure \_\_\_\_\_ 8,3 bar (120 psi)  
 Max working temperature \_\_\_\_\_ 45°C (113°F)  
 Min working temperature \_\_\_\_\_ 4°C (39,2°F)

## SPECIFICATIONS

Non-toxic materials, suitable for drinking water.  
 Head: reinforced polypropylene.  
 Clear bowl: PET.  
 Blue bowl: reinforced polypropylene.  
 O-ring: EPDM.  
 Breather-valve: body polypropylene, o-ring EPDM.  
 Drain plug: reinforced nylon.  
 Gauge plug: CW 614 N brass.  
 Metal frame: varnished galvanized steel.

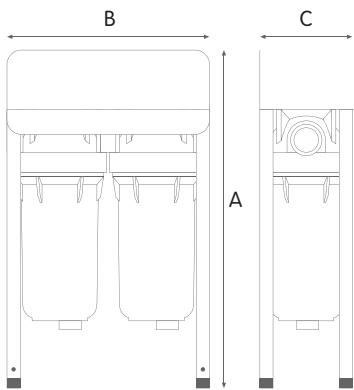

**DRAIN PLUG**

**GAUGE PLUG**



## DP BIG F PS PM DUO clear housings

### HOUSINGS WITH PLASTIC BSP THREADS

CODE	MODEL	SUITABLE CARTRIDGE	IN/OUT	DIMENSIONS mm		
				A	B	C
RA17F2711	DP BIG F PS PM 10 DUO - 1" IN TS	10"	1"	555	390	200
RA17F2911	DP BIG F PS PM 10 DUO - 1"1/2 IN TS	10"	1"1/2	555	390	200
RA18F2711	DP BIG F PS PM 20 DUO - 1" IN TS	20"	1"	805	390	200
RA18F2911	DP BIG F PS PM 20 DUO - 1"1/2 IN TS	20"	1"1/2	805	390	200

### HOUSINGS WITH PLASTIC NPT THREADS

CODE	MODEL	SUITABLE CARTRIDGE	IN/OUT	DIMENSIONS mm		
				A	B	C
RA17F2721	DP BIG F PS PM 10 DUO - 1" NPT IN TS	10"	1"	555	390	200
RA17F2921	DP BIG F PS PM 10 DUO - 1"1/2 NPT IN TS	10"	1"1/2	555	390	200
RA18F2721	DP BIG F PS PM 20 DUO - 1" NPT IN TS	20"	1"	805	390	200
RA18F2921	DP BIG F PS PM 20 DUO - 1"1/2 NPT IN TS	20"	1"1/2	805	390	200



## DP BIG F PS PM DUO blue housings

### HOUSINGS WITH PLASTIC BSP THREADS

CODE	MODEL	SUITABLE CARTRIDGE	IN/OUT	DIMENSIONS mm		
				A	B	C
RA17F2712	DP BIG F PS PM 10 DUO - 1" IN AB	10"	1"	555	390	200
RA17F2912	DP BIG F PS PM 10 DUO - 1"1/2 IN AB	10"	1"1/2	555	390	200
RA18F2712	DP BIG F PS PM 20 DUO - 1" IN AB	20"	1"	805	390	200
RA18F2912	DP BIG F PS PM 20 DUO - 1"1/2 IN AB	20"	1"1/2	805	390	200

### HOUSINGS WITH PLASTIC NPT THREADS

CODE	MODEL	SUITABLE CARTRIDGE	IN/OUT	DIMENSIONS mm		
				A	B	C
RA17F2722	DP BIG F PS PM 10 DUO - 1" NPT IN AB	10"	1"	555	390	200
RA17F2922	DP BIG F PS PM 10 DUO - 1"1/2 NPT IN AB	10"	1"1/2	555	390	200
RA18F2722	DP BIG F PS PM 20 DUO - 1" NPT IN AB	20"	1"	805	390	200
RA18F2922	DP BIG F PS PM 20 DUO - 1"1/2 NPT IN AB	20"	1"1/2	805	390	200





# DP BIG F TRIO

## WORKING CONDITIONS

Max working pressure \_\_\_\_\_ 8,3 bar (120 psi)  
 Max working temperature \_\_\_\_\_ 45°C (113°F)  
 Min working temperature \_\_\_\_\_ 4°C (39,2°F)

## SPECIFICATIONS

Non-toxic materials, suitable for drinking water.  
 Head: reinforced polypropylene.  
 Clear bowl: PET.  
 Blue bowl: reinforced polypropylene.  
 O-ring: EPDM.  
 Breather-valve: body polypropylene, o-ring EPDM.  
 Drain plug: reinforced nylon.  
 Gauge plug: CW 614 N brass.  
 Metal frame: varnished galvanized steel.

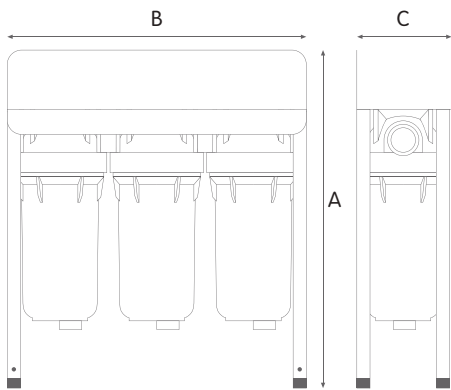

**DRAIN PLUG**

**GAUGE PLUG**



## DP BIG F PS PM TRIO clear housings

### HOUSINGS WITH PLASTIC BSP THREADS

CODE	MODEL	SUITABLE CARTRIDGE	IN/OUT	DIMENSIONS mm		
				A	B	C
RA17F3711	DP BIG F PS PM 10 TRIO - 1" IN TS	10"	1"	555	590	200
RA17F3911	DP BIG F PS PM 10 TRIO - 1"1/2 IN TS	10"	1"1/2	555	590	200
RA18F3711	DP BIG F PS PM 20 TRIO - 1" IN TS	20"	1"	805	590	200
RA18F3911	DP BIG F PS PM 20 TRIO - 1"1/2 IN TS	20"	1"1/2	805	590	200

### HOUSINGS WITH PLASTIC NPT THREADS

CODE	MODEL	SUITABLE CARTRIDGE	IN/OUT	DIMENSIONS mm		
				A	B	C
RA17F3721	DP BIG F PS PM 10 TRIO - 1" NPT IN TS	10"	1"	555	590	200
RA17F3921	DP BIG F PS PM 10 TRIO - 1"1/2 NPT IN TS	10"	1"1/2	555	590	200
RA18F3721	DP BIG F PS PM 20 TRIO - 1" NPT IN TS	20"	1"	805	590	200
RA18F3921	DP BIG F PS PM 20 TRIO - 1"1/2 NPT IN TS	20"	1"1/2	805	590	200



## DP BIG F PS PM TRIO blue housings

### HOUSINGS WITH PLASTIC BSP THREADS

CODE	MODEL	SUITABLE CARTRIDGE	IN/OUT	DIMENSIONS mm		
				A	B	C
RA17F3712	DP BIG F PS PM 10 TRIO - 1" IN AB	10"	1"	555	590	200
RA17F3912	DP BIG F PS PM 10 TRIO - 1"1/2 IN AB	10"	1"1/2	555	590	200
RA18F3712	DP BIG F PS PM 20 TRIO - 1" IN AB	20"	1"	805	590	200
RA18F3912	DP BIG F PS PM 20 TRIO - 1"1/2 IN AB	20"	1"1/2	805	590	200

### HOUSINGS WITH PLASTIC NPT THREADS

CODE	MODEL	SUITABLE CARTRIDGE	IN/OUT	DIMENSIONS mm		
				A	B	C
RA17F3722	DP BIG F PS PM 10 TRIO - 1" NPT IN AB	10"	1"	555	590	200
RA17F3922	DP BIG F PS PM 10 TRIO - 1"1/2 NPT IN AB	10"	1"1/2	555	590	200
RA18F3722	DP BIG F PS PM 20 TRIO - 1" NPT IN AB	20"	1"	805	590	200
RA18F3922	DP BIG F PS PM 20 TRIO - 1"1/2 NPT IN AB	20"	1"1/2	805	590	200



The logo consists of the word "SANIC" in a bold, white, sans-serif font, centered within a grey rectangular box. A vertical white line is positioned between the "N" and the "I".

SANIC

WATER FILTERS WITH  
ANTIMICROBIAL  
TECHNOLOGY

DP BIG FILTER  
HOUSINGS

A detailed view of a grey plastic DP BIG SANIC filter housing. The top of the housing is open, revealing a complex internal assembly of grey plastic components, including several cylindrical ports and a central distribution structure. A threaded inlet port is visible on the right side of the top cap. The housing has a textured, ribbed appearance. In the background, two rolls of white, pleated filter media are visible, one slightly behind and to the left of the other.

# DP BIG SANIC

filter housings for BIG cartridges  
with antimicrobial technology

Brand new range of  
Mono, Duo and Trio filter housings  
designed to fit "BIG" filter cartridges  
with outer diameter (OD) 4.50",  
inner diameter (ID) 1.10",  
height at 10" and 20"

Powered by Microban® antimicrobial technology

The Microban logo features the word "MICROBAN" in a bold, blue, sans-serif font. To the right of the text is a stylized icon consisting of three overlapping shapes in blue, orange, and yellow, resembling a drop or a cluster of cells.

**MICROBAN**

Microban® technology is not designed to purify drinking water, but to fight the growth of stain and odor causing bacteria on the housing and filter itself which could adversely affect filter life and performance.  
MICROBAN is a registered trademark of Microban Products Company.

# HOUSINGS DP BIG SANIC

FOR CARTRIDGES BIG SANIC SX

## Mono, Duo and Trio patented and registered models.

Brand new range of housings with antimicrobial product protection provided by a silver based antimicrobial agent included in the plastic matrix with a specific injection molding technology.

DP BIG SANIC housings are designed to work in combination with SANIC BIG filter cartridges with outer diameter 4,50" provided with the same antimicrobial technology in every single pore of their structure and keep the filter cleaner for longer.

DP BIG SANIC models are available as:

- **CLEAR housings** 10" and 20", with female in/out connections at 1" and 1 1/2" with BSP or NPT threads.
- **GREY housings** 10" and 20", with female in/out connections at 1" and 1 1/2" with BSP or NPT threads.



**SX** cartridges with standard double open end (DOE) configuration.

## ACCESSORIES INCLUDED



-DP BIG- spanner CODE RB7403019



-LUBRIKIT- single-dose lubricant for housing o-ring  
CODE RE9020650

## CERTIFICATIONS



Systems tested and certified by IAPMO RT against NSF/ANSI 42 for bacteriostasis effect. Components tested and certified by IAPMO RT against NSF/ANSI Standards 42 and 61 for material and structural integrity requirements only. In compliance with Drinking Water Treatment Units regulations, USA and Canada.



Housings are tested and certified under the most stringent procedures worldwide, in compliance with DM 25 (Italy), with the sanitary certification EAC/Ghostreghistrizia (Russia) and WaterMark (Australia).

## SYMBOLS LEGEND



For domestic use



For technical and industrial use



Filter housings made in PET, a highly recyclable plastic, are manufactured with a proprietary procedure saving up to 60% of energy in injection molding compared with standard plastics. That is one of Atlas Filtri commitments to comply with Kyoto Treaty for the reduction of green house gas (CO<sub>2</sub>) emissions in the atmosphere.

## ACCESSORIES ON DEMAND



1" brass nipples with o-ring (pair)  
CODE RB7404002

-DP BIG MONO- wall bracket  
CODE RB7401040



-DP BIG DUO- wall bracket CODE RB7401043



-DP BIG TRIO- wall bracket CODE RB7401044



-KIT LEG 10- for DP BIG 10  
CODE RB7401051

-KIT LEG 20- for DP BIG 20  
CODE RB7401052



-KIT FRAME 10 MONO- for DP BIG 10 MONO  
CODE RB7401045

-KIT FRAME 20 MONO- for DP BIG 20 MONO  
CODE RB7401046



-KIT FRAME 10 DUO- for DP BIG 10 DUO  
CODE RB7401047

-KIT FRAME 20 DUO- for DP BIG 20 DUO  
CODE RB7401048



-KIT FRAME 10 TRIO- for DP BIG 10 TRIO  
CODE RB7401049

-KIT FRAME 20 TRIO- for DP BIG 20 TRIO  
CODE RB7401050









-VT- ground fixing kit CODE LB7221134



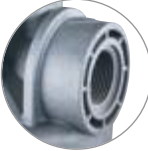
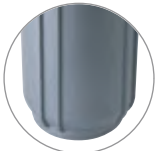
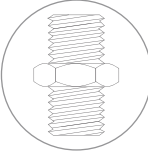

DP BIG FILTER HOUSINGS

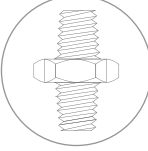
<b>DP BIG</b>	<b>10</b>	<b>MONO</b>	<b>1"</b>	<b>IN</b>	<b>SANIC TS</b>
<b>HOUSINGS MODEL</b>	<b>HOUSINGS HEIGHT</b>	<b>VERSION</b>	<b>IN / OUT</b>	<b>THREADS TYPE</b>	<b>BOWL TYPE</b>
		<b>MONO</b>	1" 1 1/2"	<b>IN - PLASTIC BSP*</b>	<b>SANIC TS - CLEAR BOWL WITH ANTI-MICROBIAL AGENT</b>
					
		<b>DUO</b>		<b>NPT IN - PLASTIC NPT**</b>	<b>SANIC BG - OPAQUE BOWL WITH ANTI-MICROBIAL AGENT</b>
					
		<b>TRIO</b>			<b>* BSP parallel (cylindrical) ISO 228</b>
					<b>** NPT tapered (conical) ANSI/ASME B1.20.1</b>





# DP BIG MONO SANIC

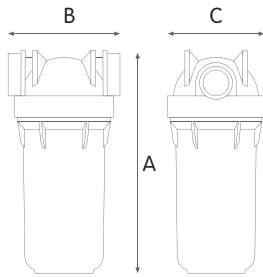

**WORKING CONDITIONS**

Max working pressure \_\_\_\_\_ 8,3 bar (120 psi)  
 Max working temperature \_\_\_\_\_ 45°C (113°F)  
 Min working temperature \_\_\_\_\_ 4°C (39,2°F)

**SPECIFICATIONS**

Non-toxic materials, suitable for drinking water.  
 Head: reinforced polypropylene.  
 Clear bowl: PET with antimicrobial technology.  
 Opaque bowl: reinforced polypropylene with antimicrobial technology.  
 O-ring: EPDM.  
 Breather-valve: body polypropylene, o-ring EPDM.

**DP BIG MONO SANIC clear housings**



**HOUSINGS WITH PLASTIC BSP THREADS**

CODE	MODEL	SUITABLE CARTRIDGE	IN/OUT	DIMENSIONS mm		
				A	B	C
SA1700711	DP BIG 10 MONO - 1" IN SANIC TS	10"	1"	360	190	185
SA1700911	DP BIG 10 MONO - 1"1/2 IN SANIC TS	10"	1"1/2	360	190	185
SA1800711	DP BIG 20 MONO - 1" IN SANIC TS	20"	1"	617	190	185
SA1800911	DP BIG 20 MONO - 1"1/2 IN SANIC TS	20"	1"1/2	617	190	185

**HOUSINGS WITH PLASTIC NPT THREADS**

CODE	MODEL	SUITABLE CARTRIDGE	IN/OUT	DIMENSIONS mm		
				A	B	C
SA1700721	DP BIG 10 MONO - 1" NPT IN SANIC TS	10"	1"	360	190	185
SA1700921	DP BIG 10 MONO - 1"1/2 NPT IN SANIC TS	10"	1"1/2	360	190	185
SA1800721	DP BIG 20 MONO - 1" NPT IN SANIC TS	20"	1"	617	190	185
SA1800921	DP BIG 20 MONO - 1"1/2 NPT IN SANIC TS	20"	1"1/2	617	190	185

**DP BIG MONO SANIC BG grey housings**



**HOUSINGS WITH PLASTIC BSP THREADS**

CODE	MODEL	SUITABLE CARTRIDGE	IN/OUT	DIMENSIONS mm		
				A	B	C
SA1700712	DP BIG 10 MONO - 1" IN SANIC BG	10"	1"	360	190	185
SA1700912	DP BIG 10 MONO - 1"1/2 IN SANIC BG	10"	1"1/2	360	190	185
SA1800712	DP BIG 20 MONO - 1" IN SANIC BG	20"	1"	617	190	185
SA1800912	DP BIG 20 MONO - 1"1/2 IN SANIC BG	20"	1"1/2	617	190	185

**HOUSINGS WITH PLASTIC NPT THREADS**

CODE	MODEL	SUITABLE CARTRIDGE	IN/OUT	DIMENSIONS mm		
				A	B	C
SA1700722	DP BIG 10 MONO - 1" NPT IN SANIC BG	10"	1"	360	190	185
SA1700922	DP BIG 10 MONO - 1"1/2 NPT IN SANIC BG	10"	1"1/2	360	190	185
SA1800722	DP BIG 20 MONO - 1" NPT IN SANIC BG	20"	1"	617	190	185
SA1800922	DP BIG 20 MONO - 1"1/2 NPT IN SANIC BG	20"	1"1/2	617	190	185



# DP BIG DUO SANIC

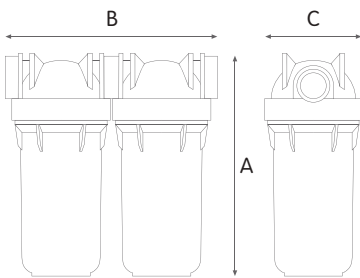

**WORKING CONDITIONS**

Max working pressure \_\_\_\_\_ 8,3 bar (120 psi)  
 Max working temperature \_\_\_\_\_ 45°C (113°F)  
 Min working temperature \_\_\_\_\_ 4°C (39,2°F)

**SPECIFICATIONS**

Non-toxic materials, suitable for drinking water.  
 Head: reinforced polypropylene.  
 Clear bowl: PET with antimicrobial technology.  
 Opaque bowl: reinforced polypropylene with antimicrobial technology.  
 O-ring: EPDM.  
 Breather-valve: body polypropylene, o-ring EPDM.



**DP BIG DUO SANIC clear housings**

**HOUSINGS WITH PLASTIC BSP THREADS**

CODE	MODEL	SUITABLE CARTRIDGE	IN/OUT	DIMENSIONS mm		
				A	B	C
SA1702711	DP BIG 10 DUO - 1" IN SANIC TS	10"	1"	375	390	185
SA1702911	DP BIG 10 DUO - 1"1/2 IN SANIC TS	10"	1"1/2	375	390	185
SA1802711	DP BIG 20 DUO - 1" IN SANIC TS	20"	1"	640	390	185
SA1802911	DP BIG 20 DUO - 1"1/2 IN SANIC TS	20"	1"1/2	640	390	185

**HOUSINGS WITH PLASTIC NPT THREADS**

CODE	MODEL	SUITABLE CARTRIDGE	IN/OUT	DIMENSIONS mm		
				A	B	C
SA1702721	DP BIG 10 DUO - 1" NPT IN SANIC TS	10"	1"	375	390	185
SA1702921	DP BIG 10 DUO - 1"1/2 NPT IN SANIC TS	10"	1"1/2	375	390	185
SA1802721	DP BIG 20 DUO - 1" NPT IN SANIC TS	20"	1"	640	390	185
SA1802921	DP BIG 20 DUO - 1"1/2 NPT IN SANIC TS	20"	1"1/2	640	390	185



**DP BIG DUO SANIC BG grey housings**

**HOUSINGS WITH PLASTIC BSP THREADS**

CODE	MODEL	SUITABLE CARTRIDGE	IN/OUT	DIMENSIONS mm		
				A	B	C
SA1702712	DP BIG 10 DUO - 1" IN SANIC BG	10"	1"	375	390	185
SA1702912	DP BIG 10 DUO - 1"1/2 IN SANIC BG	10"	1"1/2	375	390	185
SA1802712	DP BIG 20 DUO - 1" IN SANIC BG	20"	1"	640	390	185
SA1802912	DP BIG 20 DUO - 1"1/2 IN SANIC BG	20"	1"1/2	640	390	185

**HOUSINGS WITH PLASTIC NPT THREADS**

CODE	MODEL	SUITABLE CARTRIDGE	IN/OUT	DIMENSIONS mm		
				A	B	C
SA1702722	DP BIG 10 DUO - 1" NPT IN SANIC BG	10"	1"	375	390	185
SA1702922	DP BIG 10 DUO - 1"1/2 NPT IN SANIC BG	10"	1"1/2	375	390	185
SA1802722	DP BIG 20 DUO - 1" NPT IN SANIC BG	20"	1"	640	390	185
SA1802922	DP BIG 20 DUO - 1"1/2 NPT IN SANIC BG	20"	1"1/2	640	390	185

DP BIG FILTER HOUSINGS



# DP BIG TRIO SANIC

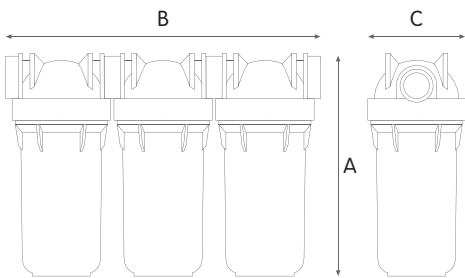

## WORKING CONDITIONS

Max working pressure \_\_\_\_\_ 8,3 bar (120 psi)  
 Max working temperature \_\_\_\_\_ 45°C (113°F)  
 Min working temperature \_\_\_\_\_ 4°C (39,2°F)

## SPECIFICATIONS

Non-toxic materials, suitable for drinking water.  
 Head: reinforced polypropylene.  
 Clear bowl: PET with antimicrobial technology.  
 Opaque bowl: reinforced polypropylene with antimicrobial technology.  
 O-ring: EPDM.  
 Breather-valve: body polypropylene, o-ring EPDM.

## DP BIG TRIO SANIC clear housings

### HOUSINGS WITH PLASTIC BSP THREADS

CODE	MODEL	SUITABLE CARTRIDGE	IN/OUT	DIMENSIONS mm		
				A	B	C
SA1703711	DP BIG 10 TRIO - 1" IN SANIC TS	10"	1"	375	590	185
SA1703911	DP BIG 10 TRIO - 1"1/2 IN SANIC TS	10"	1"1/2	375	590	185
SA1803711	DP BIG 20 TRIO - 1" IN SANIC TS	20"	1"	640	590	185
SA1803911	DP BIG 20 TRIO - 1"1/2 IN SANIC TS	20"	1"1/2	640	590	185



### HOUSINGS WITH PLASTIC NPT THREADS

CODE	MODEL	SUITABLE CARTRIDGE	IN/OUT	DIMENSIONS mm		
				A	B	C
SA1703721	DP BIG 10 TRIO - 1" NPT IN SANIC TS	10"	1"	375	590	185
SA1703921	DP BIG 10 TRIO - 1"1/2 NPT IN SANIC TS	10"	1"1/2	375	590	185
SA1803721	DP BIG 20 TRIO - 1" NPT IN SANIC TS	20"	1"	640	590	185
SA1803921	DP BIG 20 TRIO - 1"1/2 NPT IN SANIC TS	20"	1"1/2	640	590	185

## DP BIG TRIO SANIC BG grey housings

### HOUSINGS WITH PLASTIC BSP THREADS

CODE	MODEL	SUITABLE CARTRIDGE	IN/OUT	DIMENSIONS mm		
				A	B	C
SA1703712	DP BIG 10 TRIO - 1" IN SANIC BG	10"	1"	375	590	185
SA1703912	DP BIG 10 TRIO - 1"1/2 IN SANIC BG	10"	1"1/2	375	590	185
SA1803712	DP BIG 20 TRIO - 1" IN SANIC BG	20"	1"	640	590	185
SA1803912	DP BIG 20 TRIO - 1"1/2 IN SANIC BG	20"	1"1/2	640	590	185



### HOUSINGS WITH PLASTIC NPT THREADS

CODE	MODEL	SUITABLE CARTRIDGE	IN/OUT	DIMENSIONS mm		
				A	B	C
SA1703722	DP BIG 10 TRIO - 1" NPT IN SANIC BG	10"	1"	375	590	185
SA1703922	DP BIG 10 TRIO - 1"1/2 NPT IN SANIC BG	10"	1"1/2	375	590	185
SA1803722	DP BIG 20 TRIO - 1" NPT IN SANIC BG	20"	1"	640	590	185
SA1803922	DP BIG 20 TRIO - 1"1/2 NPT IN SANIC BG	20"	1"1/2	640	590	185

The logo for SAN!C, featuring the letters 'S', 'A', 'N', and 'C' in a bold, sans-serif font, with an exclamation point between 'N' and 'C'. The logo is set against a light grey rectangular background.

WATER FILTERS WITH  
ANTIMICROBIAL  
TECHNOLOGY

DP BIG FILTER  
HOUSINGS

# DP BIG F SANIC

filter housings for BIG cartridges  
with antimicrobial technology.  
With metal frame kit.

Brand new range of patented  
Mono, Duo and Trio manifold filter housings  
for filter cartridges with outer diameter  
(OD) 4.50", heights 10" and 20".

Powered by Microban® antimicrobial technology

**MICROBAN**

Microban® technology is not designed to purify drinking water, but to fight the growth of stain and odor causing bacteria on the housing and filter itself which could adversely affect filter life and performance.  
MICROBAN is a registered trademark of Microban Products Company.

# HOUSINGS DP BIG F SANIC

WITH METAL FRAME FOR CARTRIDGES BIG SX

**Brand new range of patented Mono, Duo and Trio manifold filter housings with antimicrobial product protection** provided by a silver based antimicrobial agent included in the plastic matrix with a specific injection molding technology.

**ADVANTAGES:**

- Single, double and triple patented filter housings with manifold heads for the highest safety and convenience.
- All steel Frame (legs and bracket) zinc plated and paint finished for high protection against corrosion and rust, provided in practical mounting kit.
- Extreme flexibility and easy to mount.
- **Prepared for ground fixing.**
- **Prepared for wall mounting.**
- Reduced packing size, cost-effective logistic optimization.



**SX** cartridges with standard double open end (DOE) configuration.

Wide range of dedicated 4.50" OD filter cartridges 10" and 20".

DP BIG SANIC filter housings in the frame models are available as:

- **CLEAR housings** 10" and 20", with female in/out connections at 1" and 1 1/2" with BSP or NPT threads.
- **GREY housings** 10" and 20", with female in/out connections at 1" and 1 1/2" with BSP or NPT threads.



ACCESSORIES ON DEMAND



-VT- ground fixing kit CODE LB7221134

ACCESSORIES INCLUDED



-DP BIG- spanner CODE RB7403019



-LUBRIKIT- single-dose lubricant for housing o-ring CODE RE9020650

HOUSING CERTIFICATIONS

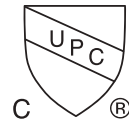

Systems tested and certified by IAPMO RT against NSF/ANSI 42 for bacteriostasis effect. Components tested and certified by IAPMO RT against NSF/ANSI Standards 42 and 61 for material and structural integrity requirements only. In compliance with Drinking Water Treatment Units regulations, USA and Canada.



Housings are tested and certified under the most stringent procedures worldwide, in compliance with DM 25 (Italy), with the sanitary certification EAC/Ghostreghistrizia (Russia) and WaterMark (Australia).

SYMBOLS LEGEND



For domestic use



For technical and industrial use









Filter housings made in PET, a highly recyclable plastic, are manufactured with a proprietary procedure saving up to 60% of energy in injection molding compared with standard plastics. That is one of Atlas Filtri commitments to comply with Kyoto Treaty for the reduction of green house gas (CO<sub>2</sub>) emissions in the atmosphere.



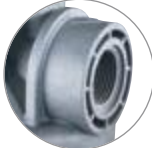

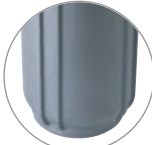
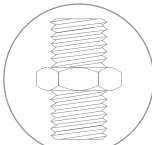
DP BIG FILTER HOUSINGS

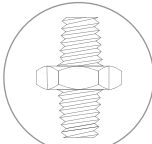
DP BIG F	10	MONO	1"	IN	SANIC TS
HOUSINGS MODEL	HOUSINGS HEIGHT	VERSION	IN / OUT	THREADS TYPE	BOWL TYPE
		MONO	1"	IN - PLASTIC BSP*	SANIC TS - CLEAR BOWL WITH ANTI-MICROBIAL AGENT
			1 1/2"		
		DUO			SANIC BG - OPAQUE BOWL WITH ANTI-MICROBIAL AGENT
					
		TRIO			* BSP parallel (cylindrical) ISO 228
					** NPT tapered (conical) ANSI/ASME B1.20.1





# DP BIG F MONO SANIC

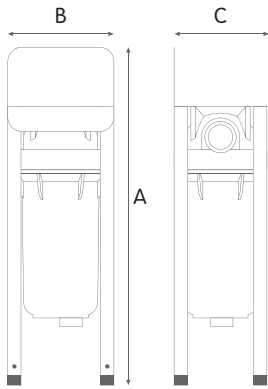

**WORKING CONDITIONS**

Max working pressure \_\_\_\_\_ 8,3 bar (120 psi)  
 Max working temperature \_\_\_\_\_ 45°C (113°F)  
 Min working temperature \_\_\_\_\_ 4°C (39,2°F)

**SPECIFICATIONS**

Non-toxic materials, suitable for drinking water.  
 Head: reinforced polypropylene.  
 Clear bowl: PET with antimicrobial technology.  
 Opaque bowl: reinforced polypropylene with antimicrobial technology.  
 O-ring: EPDM.  
 Breather-valve: body polypropylene, o-ring EPDM.  
 Metal frame: varnished galvanized steel.

## DP BIG F MONO SANIC clear housings

**HOUSINGS WITH PLASTIC BSP THREADS**

CODE	MODEL	SUITABLE CARTRIDGE	IN/OUT	DIMENSIONS mm		
				A	B	C
SA17F0711	DP BIG F 10 MONO - 1" IN SANIC	10"	1"	555	190	200
SA17F0911	DP BIG F 10 MONO - 1"1/2 IN SANIC	10"	1"1/2	555	190	200
SA18F0711	DP BIG F 20 MONO - 1" IN SANIC	20"	1"	805	190	200
SA18F0911	DP BIG F 20 MONO - 1"1/2 IN SANIC	20"	1"1/2	805	190	200



**HOUSINGS WITH PLASTIC NPT THREADS**

CODE	MODEL	SUITABLE CARTRIDGE	IN/OUT	DIMENSIONS mm		
				A	B	C
SA17F0721	DP BIG F 10 MONO - 1" NPT IN SANIC	10"	1"	555	190	200
SA17F0921	DP BIG F 10 MONO - 1"1/2 NPT IN SANIC	10"	1"1/2	555	190	200
SA18F0721	DP BIG F 20 MONO - 1" NPT IN SANIC	20"	1"	805	190	200
SA18F0921	DP BIG F 20 MONO - 1"1/2 NPT IN SANIC	20"	1"1/2	805	190	200

## DP BIG F MONO SANIC BG grey housings

**HOUSINGS WITH PLASTIC BSP THREADS**

CODE	MODEL	SUITABLE CARTRIDGE	IN/OUT	DIMENSIONS mm		
				A	B	C
SA17F0712	DP BIG F 10 MONO - 1" IN SANIC BG	10"	1"	555	190	200
SA17F0912	DP BIG F 10 MONO - 1"1/2 IN SANIC BG	10"	1"1/2	555	190	200
SA18F0712	DP BIG F 20 MONO - 1" IN SANIC BG	20"	1"	805	190	200
SA18F0912	DP BIG F 20 MONO - 1"1/2 IN SANIC BG	20"	1"1/2	805	190	200



**HOUSINGS WITH PLASTIC NPT THREADS**

CODE	MODEL	SUITABLE CARTRIDGE	IN/OUT	DIMENSIONS mm		
				A	B	C
SA17F0722	DP BIG F 10 MONO - 1" NPT IN SANIC BG	10"	1"	555	190	200
SA17F0922	DP BIG F 10 MONO - 1"1/2 NPT IN SANIC BG	10"	1"1/2	555	190	200
SA18F0722	DP BIG F 20 MONO - 1" NPT IN SANIC BG	20"	1"	805	190	200
SA18F0922	DP BIG F 20 MONO - 1"1/2 NPT IN SANIC BG	20"	1"1/2	805	190	200



# DP BIG F DUO SANIC

## WORKING CONDITIONS

Max working pressure \_\_\_\_\_ 8,3 bar (120 psi)  
 Max working temperature \_\_\_\_\_ 45°C (113°F)  
 Min working temperature \_\_\_\_\_ 4°C (39,2°F)

## SPECIFICATIONS

Non-toxic materials, suitable for drinking water.  
 Head: reinforced polypropylene.  
 Clear bowl: PET with antimicrobial technology.  
 Opaque bowl: reinforced polypropylene with antimicrobial technology.  
 O-ring: EPDM.  
 Breather-valve: body polypropylene, o-ring EPDM.  
 Metal frame: varnished galvanized steel.

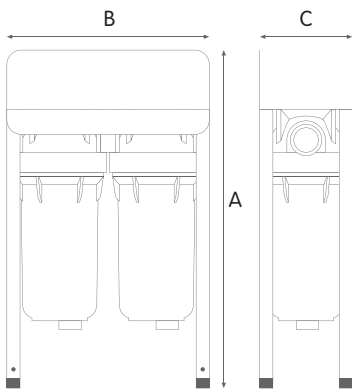

## DP BIG F DUO SANIC clear housings

### HOUSINGS WITH PLASTIC BSP THREADS

CODE	MODEL	SUITABLE CARTRIDGE	IN/OUT	DIMENSIONS mm		
				A	B	C
SA17F2711	DP BIG F 10 DUO - 1" IN SANIC	10"	1"	555	390	200
SA17F2911	DP BIG F 10 DUO - 1"1/2 IN SANIC	10"	1"1/2"	555	390	200
SA18F2711	DP BIG F 20 DUO - 1" IN SANIC	20"	1"	805	390	200
SA18F2911	DP BIG F 20 DUO - 1"1/2 IN SANIC	20"	1"1/2"	805	390	200

### HOUSINGS WITH PLASTIC NPT THREADS

CODE	MODEL	SUITABLE CARTRIDGE	IN/OUT	DIMENSIONS mm		
				A	B	C
SA17F2721	DP BIG F 10 DUO - 1" NPT IN SANIC	10"	1"	555	390	200
SA17F2921	DP BIG F 10 DUO - 1"1/2 NPT IN SANIC	10"	1"1/2"	555	390	200
SA18F2721	DP BIG F 20 DUO - 1" NPT IN SANIC	20"	1"	805	390	200
SA18F2921	DP BIG F 20 DUO - 1"1/2 NPT IN SANIC	20"	1"1/2"	805	390	200



## DP BIG F DUO SANIC BG grey housings

### HOUSINGS WITH PLASTIC BSP THREADS

CODE	MODEL	SUITABLE CARTRIDGE	IN/OUT	DIMENSIONS mm		
				A	B	C
SA17F2712	DP BIG F 10 DUO - 1" IN SANIC BG	10"	1"	555	390	200
SA17F2912	DP BIG F 10 DUO - 1"1/2 IN SANIC BG	10"	1"1/2"	555	390	200
SA18F2712	DP BIG F 20 DUO - 1" IN SANIC BG	20"	1"	805	390	200
SA18F2912	DP BIG F 20 DUO - 1"1/2 IN SANIC BG	20"	1"1/2"	805	390	200

### HOUSINGS WITH PLASTIC NPT THREADS

CODE	MODEL	SUITABLE CARTRIDGE	IN/OUT	DIMENSIONS mm		
				A	B	C
SA17F2722	DP BIG F 10 DUO - 1" NPT IN SANIC BG	10"	1"	555	390	200
SA17F2922	DP BIG F 10 DUO - 1"1/2 NPT IN SANIC BG	10"	1"1/2"	555	390	200
SA18F2722	DP BIG F 20 DUO - 1" NPT IN SANIC BG	20"	1"	805	390	200
SA18F2922	DP BIG F 20 DUO - 1"1/2 NPT IN SANIC BG	20"	1"1/2"	805	390	200



# DP BIG F TRIO SANIC

## WORKING CONDITIONS

Max working pressure \_\_\_\_\_ 8,3 bar (120 psi)  
 Max working temperature \_\_\_\_\_ 45°C (113°F)  
 Min working temperature \_\_\_\_\_ 4°C (39,2°F)

## SPECIFICATIONS

Non-toxic materials, suitable for drinking water.  
 Head: reinforced polypropylene.  
 Clear bowl: PET with antimicrobial technology.  
 Opaque bowl: reinforced polypropylene with antimicrobial technology.  
 O-ring: EPDM.  
 Breather-valve: body polypropylene, o-ring EPDM.  
 Metal frame: varnished galvanized steel.

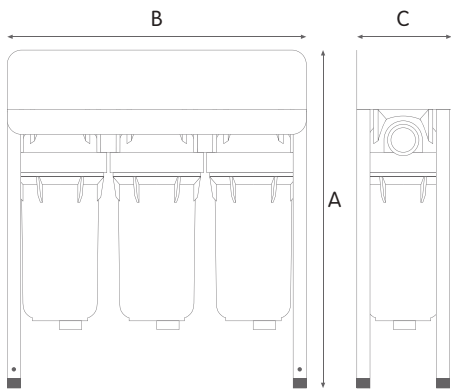

## DP BIG F TRIO SANIC clear housings

### HOUSINGS WITH PLASTIC BSP THREADS

CODE	MODEL	SUITABLE CARTRIDGE	IN/OUT	DIMENSIONS mm		
				A	B	C
SA17F3711	DP BIG F 10 TRIO - 1" IN SANIC	10"	1"	555	590	200
SA17F3911	DP BIG F 10 TRIO - 1"1/2 IN SANIC	10"	1"1/2	555	590	200
SA18F3711	DP BIG F 20 TRIO - 1" IN SANIC	20"	1"	805	590	200
SA18F3911	DP BIG F 20 TRIO - 1"1/2 IN SANIC	20"	1"1/2	805	590	200



### HOUSINGS WITH PLASTIC NPT THREADS

CODE	MODEL	SUITABLE CARTRIDGE	IN/OUT	DIMENSIONS mm		
				A	B	C
SA17F3721	DP BIG F 10 TRIO - 1" NPT IN SANIC	10"	1"	555	590	200
SA17F3921	DP BIG F 10 TRIO - 1"1/2 NPT IN SANIC	10"	1"1/2	555	590	200
SA18F3721	DP BIG F 20 TRIO - 1" NPT IN SANIC	20"	1"	805	590	200
SA18F3921	DP BIG F 20 TRIO - 1"1/2 NPT IN SANIC	20"	1"1/2	805	590	200

## DP BIG F TRIO SANIC BG grey housings

### HOUSINGS WITH PLASTIC BSP THREADS

CODE	MODEL	SUITABLE CARTRIDGE	IN/OUT	DIMENSIONS mm		
				A	B	C
SA17F3712	DP BIG F 10 TRIO - 1" IN SANIC BG	10"	1"	555	590	200
SA17F3912	DP BIG F 10 TRIO - 1"1/2 IN SANIC BG	10"	1"1/2	555	590	200
SA18F3712	DP BIG F 20 TRIO - 1" IN SANIC BG	20"	1"	805	590	200
SA18F3912	DP BIG F 20 TRIO - 1"1/2 IN SANIC BG	20"	1"1/2	805	590	200



### HOUSINGS WITH PLASTIC NPT THREADS

CODE	MODEL	SUITABLE CARTRIDGE	IN/OUT	DIMENSIONS mm		
				A	B	C
SA17F3722	DP BIG F 10 TRIO - 1" NPT IN SANIC BG	10"	1"	555	590	200
SA17F3922	DP BIG F 10 TRIO - 1"1/2 NPT IN SANIC BG	10"	1"1/2	555	590	200
SA18F3722	DP BIG F 20 TRIO - 1" NPT IN SANIC BG	20"	1"	805	590	200
SA18F3922	DP BIG F 20 TRIO - 1"1/2 NPT IN SANIC BG	20"	1"1/2	805	590	200



# HYDRA

self-cleaning filters

full range of self-cleaning filters with innovative solutions for the efficiency of self-cleaning operation, thanks to a newly designed back-wash system in counter-current which grants the highest particle removal from the filter cartridge

# HYDRA SELF-CLEANING FILTERS



Housings HYDRA fit to **EXCLUSIVE HYDRA FILTER CARTRIDGES.**

**SX** cartridges with antimicrobial flat seal.

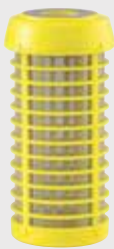

**RAH**  
stainless steel net cartridge, filtration at 90 micron.  
CODE RA5000020

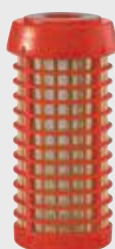

**RAH HOT**  
stainless steel net cartridge, filtration at 90 micron.  
CODE RA5080020



**RLH**  
plastic net cartridge, filtration at 90 micron.  
CODE RA5000010



**RSH**  
pleated plastic net cartridge, filtration at 50 micron.  
CODE RA5000040



All cartridges are provided with dedicated **stainless steel AISI 302 cartridge spring.**  
CODE RE7120040

## FLOW RATE vs PRESSURE DROP $\Delta p$

Testing mode: 20°C, 3 BAR

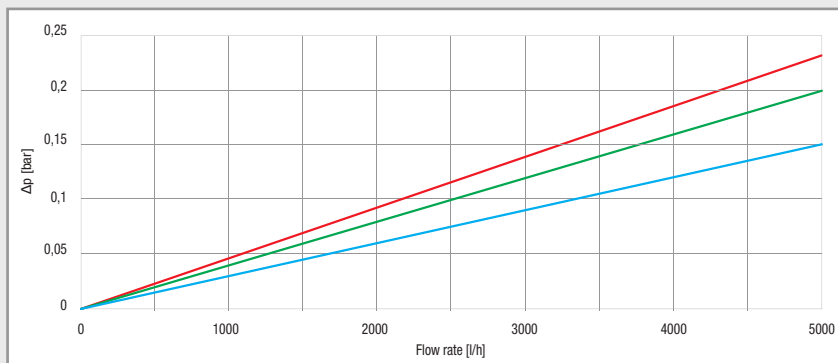

## CERTIFICATIONS



A range of housings is certified by IAPMO RT to NSF/ANSI 42, 61, 372 - lead free, CSA B483.1. In compliance with Drinking Water Treatment Units regulations, USA and CANADA.



Housings are tested and certified under the most stringent procedures worldwide, in compliance with DM 25 (Italy), with the sanitary certification ACS (France), EAC/Ghostregistrazia (Russia) and WaterMark (Australia).

## SYMBOLS LEGEND



For domestic use



For technical and industrial use



Filter housings made in PET, a highly recyclable plastic, are manufactured with a proprietary procedure saving up to 60% of energy in injection molding compared with standard plastics. That is one of Atlas Filtri commitments to comply with Kyoto Treaty for the reduction of green house gas (CO<sub>2</sub>) emissions in the atmosphere.

## ACCESSORIES ON DEMAND



brass hose-holder  
CODE RE7120026



3/4" / 1" brass nipples with o-ring (pair)  
CODE RB7404001 / CODE RB7404002



-KIT AUTO- CODE RE7120024  
automatic discharge kit (see pages 186-187)



-LUBRIKIT- single-dose lubricant for housing o-ring  
CODE RE9020650

## ACCESSORIES INCLUDED



-X- spanner



-S- wall bracket  
(for HYDRA and HYDRA HOT)



-K DP- wall bracket (for HYDRA K DP) CODE RB7400021

## DISCHARGE KIT



brass discharge ball-valve with gasket



plastic hose-holder



drain funnel

In compliance with the European Standard UNI EN 1717/2002: designed to prevent back-flow contamination by making all elements downstream the discharge vent to atmosphere (protection unit symbol: DC)



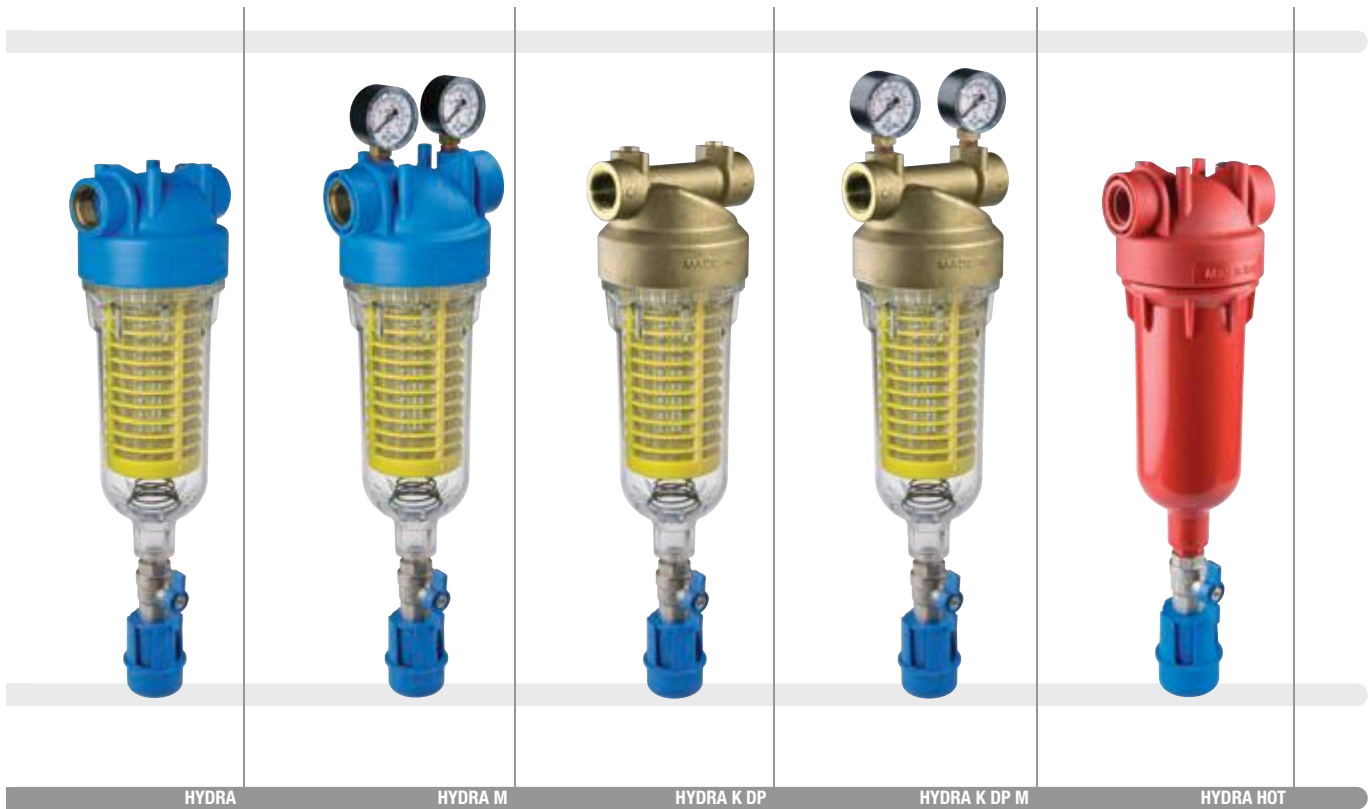

SELF-CLEANING  
FILTERS

HYDRA

FILTER MODEL

3/4

IN / OUT

1/2"

3/4"

1"

1 1/4"

1 1/2"

RLH 90 mcr

FILTER CARTRIDGE

RSH 50 mcr

RLH 90 mcr

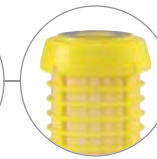

RAH HOT 90 mcr

RAH 90 mcr

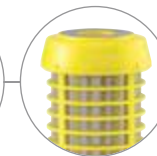

OT

THREADS TYPE

OT - BRASS BSP \*

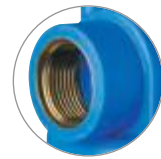

IN - PLASTIC BSP \*

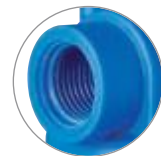

NPT IN - PLASTIC NPT \*\*

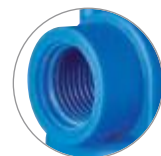

MP - PLASTIC BSP \*

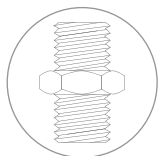
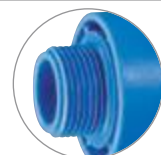

\* BSP  
parallel (cylindrical)  
ISO 228

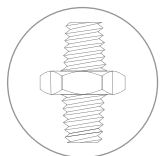

\*\* NPT  
tapered (conical)  
ANSI/ASME B1.20.1





# HYDRA

## WORKING CONDITIONS

Max working pressure:  
 BSP versions \_\_\_\_\_ 8 bar (116 psi)  
 NPT versions \_\_\_\_\_ 8,6 bar (125 psi)  
 Min working pressure \_\_\_\_\_ 1,8 bar (26 psi)  
 Max working temperature \_\_\_\_\_ 45°C (113°F)  
 Min working temperature \_\_\_\_\_ 4°C (39,2°F)

## SPECIFICATIONS

Non-toxic materials, suitable for drinking water.  
 Head: reinforced polypropylene.  
 Bowl: PET.  
 O-ring: EPDM.  
 Breather-valve: body stainless steel, o-ring EPDM.  
 IN/OUT brass threads: CW 617 N brass.  
 Discharge ball-valve: CW 617 N brass nickel plated.  
 Drain funnel: reinforced polypropylene.

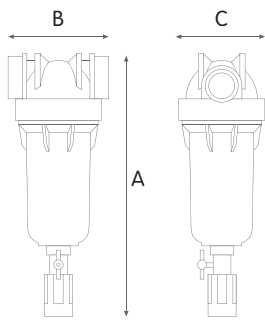

**DRAIN FUNNEL**  
 Back-flow preventing device  
 UNI EN 1717-11/2002

## HYDRA RLH single-stage self-cleaning filters

### HOUSINGS WITH BRASS BSP THREADS

CODE	MODEL	NOMINAL FILTRATION MICRON	IN/OUT	FLOW RATE I/h	DIMENSIONS mm		
					A	B	C
RA6000010	HYDRA 1/2" RLH 90 mcr OT	90	1/2"	3500	390	120	107
RA6000011	HYDRA 3/4" RLH 90 mcr OT	90	3/4"	5000	390	120	107
RA6000012	HYDRA 1" RLH 90 mcr OT	90	1"	6000	390	120	107
RA6000022	HYDRA 1"1/4 RLH 90 mcr OT	90	1"1/4	8000	415	120	107
RA6000023	HYDRA 1"1/2 RLH 90 mcr OT	90	1"1/2	10000	415	120	107

### HOUSINGS WITH PLASTIC BSP THREADS

CODE	MODEL	NOMINAL FILTRATION MICRON	IN/OUT	FLOW RATE I/h	DIMENSIONS mm		
					A	B	C
RA6000028	HYDRA 1/2" RLH 90 mcr IN	90	1/2"	3500	390	120	107
RA6000029	HYDRA 3/4" RLH 90 mcr IN	90	3/4"	5000	390	120	107
RA6000030	HYDRA 1" RLH 90 mcr IN	90	1"	6000	390	120	107

### HOUSINGS WITH PLASTIC NPT THREADS

CODE	MODEL	NOMINAL FILTRATION MICRON	IN/OUT	FLOW RATE I/h	DIMENSIONS mm		
					A	B	C
RA6000053	HYDRA 1/2" RLH 90 mcr NPT IN	90	1/2"	5000	390	120	107
RA6000033	HYDRA 3/4" RLH 90 mcr NPT IN	90	3/4"	5000	390	120	107
RA6000034	HYDRA 1" RLH 90 mcr NPT IN	90	1"	6000	390	120	107

### HOUSINGS WITH PLASTIC BSP THREADS

CODE	MODEL	NOMINAL FILTRATION MICRON	IN/OUT	FLOW RATE I/h	DIMENSIONS mm		
					A	B	C
RA6000060	HYDRA 1/2" RLH 90 mcr MP	90	1/2"	3500	390	155	107
RA6000061	HYDRA 3/4" RLH 90 mcr MP	90	3/4"	5000	390	155	107
RA6000062	HYDRA 1" RLH 90 mcr MP	90	1"	6000	390	155	107



Some items in the list are subject to minimum order quantities and/or to longer delivery term.

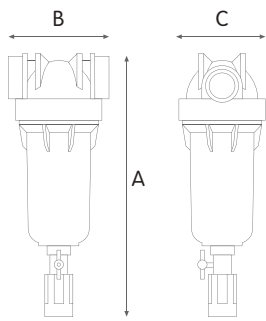

**WORKING CONDITIONS**

Max working pressure:  
 BSP versions \_\_\_\_\_ 8 bar (116 psi)  
 NPT versions \_\_\_\_\_ 8,6 bar (125 psi)  
 Min working pressure \_\_\_\_\_ 1,8 bar (26 psi)  
 Max working temperature \_\_\_\_\_ 45°C (113°F)  
 Min working temperature \_\_\_\_\_ 4°C (39,2°F)



**DRAIN FUNNEL**  
 Back-flow preventing device  
 UNI EN 1717-11/2002

**SPECIFICATIONS**

Non-toxic materials, suitable for drinking water.  
 Head: reinforced polypropylene.  
 Bowl: PET.  
 O-ring: EPDM.  
 Breather-valve: body stainless steel, o-ring EPDM.  
 IN/OUT brass threads: CW 617 N brass.  
 Discharge ball-valve: CW 617 N brass nickel plated.  
 Drain funnel: reinforced polypropylene.

**HYDRA RAH single-stage self-cleaning filters**

**HOUSINGS WITH BRASS BSP THREADS**

CODE	MODEL	NOMINAL FILTRATION MICRON	IN/OUT	FLOW RATE l/h	DIMENSIONS mm		
					A	B	C
RA6000013	HYDRA 1/2" RAH 90 mcr OT	90	1/2"	3500	390	120	107
RA6000014	HYDRA 3/4" RAH 90 mcr OT	90	3/4"	5000	390	120	107
RA6000015	HYDRA 1" RAH 90 mcr OT	90	1"	6000	390	120	107
RA6000024	HYDRA 1"1/4 RAH 90 mcr OT	90	1"1/4	8000	415	120	107
RA6000025	HYDRA 1"1/2 RAH 90 mcr OT	90	1"1/2	10000	415	120	107

**HOUSINGS WITH PLASTIC BSP THREADS**

CODE	MODEL	NOMINAL FILTRATION MICRON	IN/OUT	FLOW RATE l/h	DIMENSIONS mm		
					A	B	C
RA6000035	HYDRA 1/2" RAH 90 mcr IN	90	1/2"	3500	390	120	107
RA6000036	HYDRA 3/4" RAH 90 mcr IN	90	3/4"	5000	390	120	107
RA6000037	HYDRA 1" RAH 90 mcr IN	90	1"	6000	390	120	107

**HOUSINGS WITH PLASTIC NPT THREADS**

CODE	MODEL	NOMINAL FILTRATION MICRON	IN/OUT	FLOW RATE l/h	DIMENSIONS mm		
					A	B	C
RA6000054	HYDRA 1/2" RAH 90 mcr NPT IN	90	1/2"	5000	390	120	107
RA6000040	HYDRA 3/4" RAH 90 mcr NPT IN	90	3/4"	5000	390	120	107
RA6000041	HYDRA 1" RAH 90 mcr NPT IN	90	1"	6000	390	120	107

**HOUSINGS WITH PLASTIC BSP THREADS**

CODE	MODEL	NOMINAL FILTRATION MICRON	IN/OUT	FLOW RATE l/h	DIMENSIONS mm		
					A	B	C
RA6000070	HYDRA 1/2" RAH 90 mcr MP	90	1/2"	3500	390	155	107
RA6000071	HYDRA 3/4" RAH 90 mcr MP	90	3/4"	5000	390	155	107
RA6000072	HYDRA 1" RAH 90 mcr MP	90	1"	6000	390	155	107

SELF-CLEANING FILTERS

Some items in the list are subject to minimum order quantities and/or to longer delivery term.

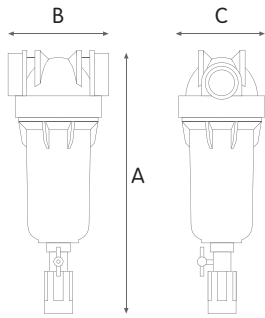

**WORKING CONDITIONS**

Max working pressure:  
 BSP versions \_\_\_\_\_ 8 bar (116 psi)  
 NPT versions \_\_\_\_\_ 8,6 bar (125 psi)  
 Min working pressure \_\_\_\_\_ 1,8 bar (26 psi)  
 Max working temperature \_\_\_\_\_ 45°C (113°F)  
 Min working temperature \_\_\_\_\_ 4°C (39,2°F)

**SPECIFICATIONS**

Non-toxic materials, suitable for drinking water.  
 Head: reinforced polypropylene.  
 Bowl: PET.  
 O-ring: EPDM.  
 Breather-valve: body stainless steel, o-ring EPDM.  
 IN/OUT brass threads: CW 617 N brass.  
 Discharge ball-valve: CW 617 N brass nickel plated.  
 Drain funnel: reinforced polypropylene.



**DRAIN FUNNEL**  
 Back-flow preventing device  
 UNI EN 1717-11/2002

**HYDRA RSH single-stage self-cleaning filters**

**HOUSINGS WITH BRASS BSP THREADS**

CODE	MODEL	NOMINAL FILTRATION MICRON	IN/OUT	FLOW RATE l/h	DIMENSIONS mm		
					A	B	C
RA6000019	HYDRA 1/2" RSH 50 mcr OT	50	1/2"	3500	390	120	107
RA6000020	HYDRA 3/4" RSH 50 mcr OT	50	3/4"	5000	390	120	107
RA6000021	HYDRA 1" RSH 50 mcr OT	50	1"	6000	390	120	107
RA6000026	HYDRA 1"1/4 RSH 50 mcr OT	50	1"1/4	8000	415	120	107
RA6000027	HYDRA 1"1/2 RSH 50 mcr OT	50	1"1/2	10000	415	120	107

**HOUSINGS WITH PLASTIC BSP THREADS**

CODE	MODEL	NOMINAL FILTRATION MICRON	IN/OUT	FLOW RATE l/h	DIMENSIONS mm		
					A	B	C
RA6000042	HYDRA 1/2" RSH 50 mcr IN	50	1/2"	3500	390	120	107
RA6000043	HYDRA 3/4" RSH 50 mcr IN	50	3/4"	5000	390	120	107
RA6000044	HYDRA 1" RSH 50 mcr IN	50	1"	6000	390	120	107

**HOUSINGS WITH PLASTIC NPT THREADS**

CODE	MODEL	NOMINAL FILTRATION MICRON	IN/OUT	FLOW RATE l/h	DIMENSIONS mm		
					A	B	C
RA6000055	HYDRA 1/2" RSH 50 mcr NPT IN	50	1/2"	5000	390	120	107
RA6000047	HYDRA 3/4" RSH 50 mcr NPT IN	50	3/4"	5000	390	120	107
RA6000048	HYDRA 1" RSH 50 mcr NPT IN	50	1"	6000	390	120	107

**HOUSINGS WITH PLASTIC BSP THREADS**

CODE	MODEL	NOMINAL FILTRATION MICRON	IN/OUT	FLOW RATE l/h	DIMENSIONS mm		
					A	B	C
RA6000080	HYDRA 1/2" RSH 50 mcr MP	50	1/2"	3500	390	155	107
RA6000081	HYDRA 3/4" RSH 50 mcr MP	50	3/4"	5000	390	155	107
RA6000082	HYDRA 1" RSH 50 mcr MP	50	1"	6000	390	155	107

Some items in the list are subject to minimum order quantities and/or to longer delivery term.



# HYDRA M

## WORKING CONDITIONS

Max working pressure:  
 BSP versions \_\_\_\_\_ 8 bar (116 psi)  
 NPT versions \_\_\_\_\_ 8,6 bar (125 psi)  
 Min working pressure \_\_\_\_\_ 1,8 bar (26 psi)  
 Max working temperature \_\_\_\_\_ 45°C (113°F)  
 Min working temperature \_\_\_\_\_ 4°C (39,2°F)

## SPECIFICATIONS

Non-toxic materials, suitable for drinking water.  
 Head: reinforced polypropylene.  
 Bowl: PET.  
 O-ring: EPDM.  
 IN/OUT brass threads: CW 617 N brass.  
 Manometers: radial type, pressure range 0-12 bar, 0-170 psi.  
 Discharge ball-valve: CW 617 N brass nickel plated.  
 Drain funnel: reinforced polypropylene.

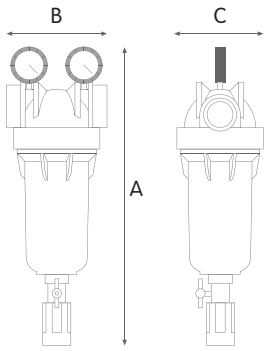

**DRAIN FUNNEL**  
 Back-flow preventing device  
 UNI EN 1717-11/2002

## HYDRA M RLH single-stage self-cleaning filters with 2 manometers

### HOUSINGS WITH BRASS BSP THREADS

CODE	MODEL	NOMINAL FILTRATION MICRON	IN/OUT	FLOW RATE l/h	DIMENSIONS mm		
					A	B	C
RA6000110	HYDRA M 1/2" RLH 90 mcr OT	90	1/2"	3500	445	120	107
RA6000111	HYDRA M 3/4" RLH 90 mcr OT	90	3/4"	5000	445	120	107
RA6000112	HYDRA M 1" RLH 90 mcr OT	90	1"	6000	445	120	107
RA6000113	HYDRA M 1 1/4" RLH 90 mcr OT	90	1 1/4"	8000	460	120	107
RA6000114	HYDRA M 1 1/2" RLH 90 mcr OT	90	1 1/2"	10000	460	120	107



### HOUSINGS WITH PLASTIC BSP THREADS

CODE	MODEL	NOMINAL FILTRATION MICRON	IN/OUT	FLOW RATE l/h	DIMENSIONS mm		
					A	B	C
RA6000125	HYDRA M 1/2" RLH 90 mcr IN	90	1/2"	3500	445	120	107
RA6000126	HYDRA M 3/4" RLH 90 mcr IN	90	3/4"	5000	445	120	107
RA6000127	HYDRA M 1" RLH 90 mcr IN	90	1"	6000	445	120	107



### HOUSINGS WITH PLASTIC NPT THREADS

CODE	MODEL	NOMINAL FILTRATION MICRON	IN/OUT	FLOW RATE l/h	DIMENSIONS mm		
					A	B	C
RA6000130	HYDRA M 3/4" RLH 90 mcr NPT IN	90	3/4"	5000	445	120	107
RA6000133	HYDRA M 1" RLH 90 mcr NPT IN	90	1"	6000	445	120	107

SELF-CLEANING FILTERS

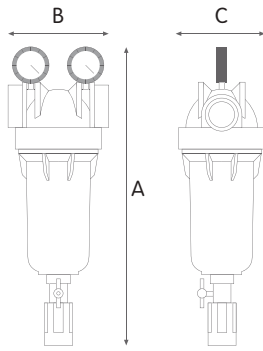

**WORKING CONDITIONS**

Max working pressure:  
 BSP versions \_\_\_\_\_ 8 bar (116 psi)  
 NPT versions \_\_\_\_\_ 8,6 bar (125 psi)  
 Min working pressure \_\_\_\_\_ 1,8 bar (26 psi)  
 Max working temperature \_\_\_\_\_ 45°C (113°F)  
 Min working temperature \_\_\_\_\_ 4°C (39,2°F)

**SPECIFICATIONS**

Non-toxic materials, suitable for drinking water.  
 Head: reinforced polypropylene.  
 Bowl: PET.  
 O-ring: EPDM.  
 IN/OUT brass threads: CW 617 N brass.  
 Manometers: radial type, pressure range 0-12 bar, 0-170 psi.  
 Discharge ball-valve: CW 617 N brass nickel plated.  
 Drain funnel: reinforced polypropylene.



**DRAIN FUNNEL**  
 Back-flow preventing device  
 UNI EN 1717-11/2002

**HYDRA M RAH single-stage self-cleaning filters with 2 manometers**

**HOUSINGS WITH BRASS BSP THREADS**

CODE	MODEL	NOMINAL FILTRATION MICRON	IN/OUT	FLOW RATE l/h	DIMENSIONS mm		
					A	B	C
RA6000115	HYDRA M 1/2" RAH 90 mcr OT	90	1/2"	3500	445	120	107
RA6000116	HYDRA M 3/4" RAH 90 mcr OT	90	3/4"	5000	445	120	107
RA6000117	HYDRA M 1" RAH 90 mcr OT	90	1"	6000	445	120	107
RA6000118	HYDRA M 1 1/4" RAH 90 mcr OT	90	1 1/4"	8000	460	120	107
RA6000119	HYDRA M 1 1/2" RAH 90 mcr OT	90	1 1/2"	10000	460	120	107

**HOUSINGS WITH PLASTIC BSP THREADS**

CODE	MODEL	NOMINAL FILTRATION MICRON	IN/OUT	FLOW RATE l/h	DIMENSIONS mm		
					A	B	C
RA6000134	HYDRA M 1/2" RAH 90 mcr IN	90	1/2"	3500	445	120	107
RA6000135	HYDRA M 3/4" RAH 90 mcr IN	90	3/4"	5000	445	120	107
RA6000136	HYDRA M 1" RAH 90 mcr IN	90	1"	6000	445	120	107

**HOUSINGS WITH PLASTIC NPT THREADS**

CODE	MODEL	NOMINAL FILTRATION MICRON	IN/OUT	FLOW RATE l/h	DIMENSIONS mm		
					A	B	C
RA6000139	HYDRA M 3/4" RAH 90 mcr NPT IN	90	3/4"	5000	445	120	107
RA6000140	HYDRA M 1" RAH 90 mcr NPT IN	90	1"	6000	445	120	107

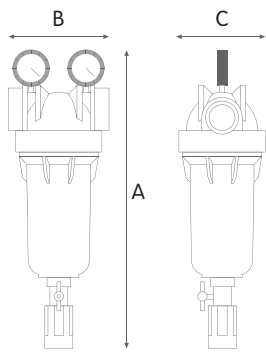

**WORKING CONDITIONS**

Max working pressure:  
 BSP versions \_\_\_\_\_ 8 bar (116 psi)  
 NPT versions \_\_\_\_\_ 8,6 bar (125 psi)  
 Min working pressure \_\_\_\_\_ 1,8 bar (26 psi)  
 Max working temperature \_\_\_\_\_ 45°C (113°F)  
 Min working temperature \_\_\_\_\_ 4°C (39,2°F)



**DRAIN FUNNEL**  
 Back-flow preventing device  
 UNI EN 1717-11/2002

**SPECIFICATIONS**

Non-toxic materials, suitable for drinking water.  
 Head: reinforced polypropylene.  
 Bowl: PET.  
 O-ring: EPDM.  
 IN/OUT brass threads: CW 617 N brass.  
 Manometers: radial type, pressure range 0-12 bar, 0-170 psi.  
 Discharge ball-valve: CW 617 N brass nickel plated.  
 Drain funnel: reinforced polypropylene.

**HYDRA M RSH single-stage self-cleaning filters with 2 manometers**

**HOUSINGS WITH BRASS BSP THREADS**

CODE	MODEL	NOMINAL FILTRATION MICRON	IN/OUT	FLOW RATE l/h	DIMENSIONS mm		
					A	B	C
RA6000120	HYDRA M 1/2" RSH 50 mcr OT	50	1/2"	3500	445	120	107
RA6000121	HYDRA M 3/4" RSH 50 mcr OT	50	3/4"	5000	445	120	107
RA6000122	HYDRA M 1" RSH 50 mcr OT	50	1"	6000	445	120	107
RA6000123	HYDRA M 1"1/4 RSH 50 mcr OT	50	1"1/4	8000	460	120	107
RA6000124	HYDRA M 1"1/2 RSH 50 mcr OT	50	1"1/2	10000	460	120	107

**HOUSINGS WITH PLASTIC BSP THREADS**

CODE	MODEL	NOMINAL FILTRATION MICRON	IN/OUT	FLOW RATE l/h	DIMENSIONS mm		
					A	B	C
RA6000141	HYDRA M 1/2" RSH 50 mcr IN	50	1/2"	3500	445	120	107
RA6000142	HYDRA M 3/4" RSH 50 mcr IN	50	3/4"	5000	445	120	107
RA6000143	HYDRA M 1" RSH 50 mcr IN	50	1"	6000	445	120	107

**HOUSINGS WITH PLASTIC NPT THREADS**

CODE	MODEL	NOMINAL FILTRATION MICRON	IN/OUT	FLOW RATE l/h	DIMENSIONS mm		
					A	B	C
RA6000146	HYDRA M 3/4" RSH 50 mcr NPT IN	50	3/4"	5000	445	120	107
RA6000147	HYDRA M 1" RSH 50 mcr NPT IN	50	1"	6000	445	120	107





# HYDRA K DP

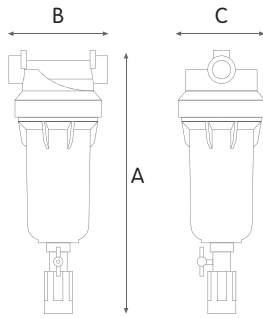

## WORKING CONDITIONS

Max working pressure \_\_\_\_\_ 10 bar (145 psi)  
 Min working pressure \_\_\_\_\_ 1,8 bar (26 psi)  
 Max working temperature \_\_\_\_\_ 45°C (113°F)  
 Min working temperature \_\_\_\_\_ 4°C (39,2°F)

## SPECIFICATIONS

Non-toxic materials, suitable for drinking water.  
 Head: CB 753 S brass.  
 Bowl: PET.  
 O-ring: EPDM.  
 Breather-valve: CW 614 N brass.  
 Discharge ball-valve: CW 617 N brass nickel plated.  
 Drain funnel: reinforced polypropylene.



**DRAIN FUNNEL**  
 Back-flow preventing device  
 UNI EN 1717-11/2002

## HYDRA K DP RLH single-stage self-cleanig filters

### HOUSINGS WITH BRASS BSP THREADS

CODE	MODEL	NOMINAL FILTRATION MICRON	IN/OUT	FLOW RATE l/h	DIMENSIONS mm		
					A	B	C
RA6000801	HYDRA K DP 3/4" RLH 90 mcr	90	3/4"	5000	430	120	107
RA6000802	HYDRA K DP 1" RLH 90 mcr	90	1"	6000	430	120	107

## HYDRA K DP RAH single-stage self-cleanig filters

### HOUSINGS WITH BRASS BSP THREADS

CODE	MODEL	NOMINAL FILTRATION MICRON	IN/OUT	FLOW RATE l/h	DIMENSIONS mm		
					A	B	C
RA6000803	HYDRA K DP 3/4" RAH 90 mcr	90	3/4"	5000	430	120	107
RA6000804	HYDRA K DP 1" RAH 90 mcr	90	1"	6000	430	120	107

## HYDRA K DP RSH single-stage self-cleanig filters

### HOUSINGS WITH BRASS BSP THREADS

CODE	MODEL	NOMINAL FILTRATION MICRON	IN/OUT	FLOW RATE l/h	DIMENSIONS mm		
					A	B	C
RA6000805	HYDRA K DP 3/4" RSH 50 mcr	50	3/4"	5000	430	120	107
RA6000806	HYDRA K DP 1" RSH 50 mcr	50	1"	6000	430	120	107



# HYDRA K DP M

## WORKING CONDITIONS

Max working pressure \_\_\_\_\_ 10 bar (145 psi)  
 Min working pressure \_\_\_\_\_ 1,8 bar (26 psi)  
 Max working temperature \_\_\_\_\_ 45°C (113°F)  
 Min working temperature \_\_\_\_\_ 4°C (39,2°F)

## SPECIFICATIONS

Non-toxic materials, suitable for drinking water.  
 Head: CB 753 S brass.  
 Bowl: PET.  
 O-ring: EPDM.  
 Manometers: radial type, pressure range 0-12 bar, 0-170 psi.  
 Discharge ball-valve: CW 617 N brass nickel plated.  
 Drain funnel: reinforced polypropylene.

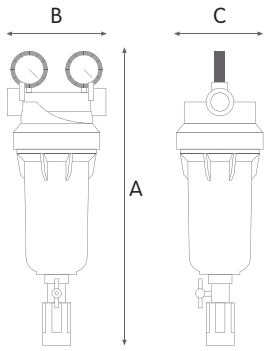

**DRAIN FUNNEL**  
 Back-flow preventing device  
 UNI EN 1717-11/2002

## HYDRA K DP M RLH single-stage self-cleaning filters with 2 manometers

### HOUSINGS WITH BRASS BSP THREADS

CODE	MODEL	NOMINAL FILTRATION MICRON	IN/OUT	FLOW RATE l/h	DIMENSIONS mm		
					A	B	C
RA6000811	HYDRA K DP M 3/4" RLH 90 mcr	90	3/4"	5000	460	120	107
RA6000812	HYDRA K DP M 1" RLH 90 mcr	90	1"	6000	460	120	107



## HYDRA K DP M RAH single-stage self-cleaning filters with 2 manometers

### HOUSINGS WITH BRASS BSP THREADS

CODE	MODEL	NOMINAL FILTRATION MICRON	IN/OUT	FLOW RATE l/h	DIMENSIONS mm		
					A	B	C
RA6000813	HYDRA K DP M 3/4" RAH 90 mcr	90	3/4"	5000	460	120	107
RA6000814	HYDRA K DP M 1" RAH 90 mcr	90	1"	6000	460	120	107



## HYDRA K DP M RSH single-stage self-cleaning filters with 2 manometers

### HOUSINGS WITH BRASS BSP THREADS

CODE	MODEL	NOMINAL FILTRATION MICRON	IN/OUT	FLOW RATE l/h	DIMENSIONS mm		
					A	B	C
RA6000815	HYDRA K DP M 3/4" RSH 50 mcr	50	3/4"	5000	460	120	107
RA6000816	HYDRA K DP M 1" RSH 50 mcr	50	1"	6000	460	120	107





# HYDRA HOT

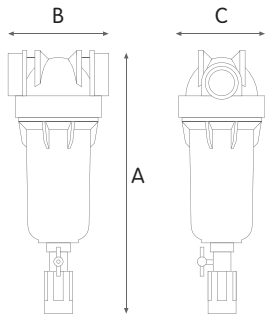

## WORKING CONDITIONS

Max working pressure \_\_\_\_\_ 8,6 bar (125 psi)  
 Min working pressure \_\_\_\_\_ 1,8 bar (26 psi)  
 Max working temperature \_\_\_\_\_ 80°C (176°F)  
 Min working temperature \_\_\_\_\_ 4°C (39,2°F)

## SPECIFICATIONS

Non-toxic materials.  
 Head: reinforced nylon.  
 Bowl: reinforced nylon.  
 O-ring: EPDM.  
 Breather-valve: body stainless steel, o-ring EPDM.  
 Discharge ball-valve: CW 617 N brass nickel plated.  
 Drain funnel: reinforced polypropylene.



**DRAIN FUNNEL**  
 Back-flow  
 preventing device  
 UNI EN 1717-11/2002

## HYDRA HOT single-stage self-cleanig filters

### HOUSINGS WITH PLASTIC BSP THREADS

CODE	MODEL	NOMINAL FILTRATION MICRON	IN/OUT	FLOW RATE l/h	DIMENSIONS mm		
					A	B	C
RA6000001	HYDRA HOT 1/2" RAH 90 mcr IN	90	1/2"	3500	390	120	107
RA6000002	HYDRA HOT 3/4" RAH 90 mcr IN	90	3/4"	5000	390	120	107
RA6000003	HYDRA HOT 1" RAH 90 mcr IN	90	1"	6000	390	120	107

### HOUSINGS WITH PLASTIC NPT THREADS

CODE	MODEL	NOMINAL FILTRATION MICRON	IN/OUT	FLOW RATE l/h	DIMENSIONS mm		
					A	B	C
RA6000005	HYDRA HOT 3/4" RAH 90 mcr NPT IN	90	3/4"	5000	390	120	107
RA6000006	HYDRA HOT 1" RAH 90 mcr NPT IN	90	1"	6000	390	120	107

## CERTIFICATIONS



A range of housings is certified by IAPMO RT to NSF/ANSI 42 - Structural Integrity Only and CSA B483.1 - Structural Integrity Only. In compliance with drinking water regulations, USA and CANADA.

Some items in the list are subject to minimum order quantities and/or to longer delivery term.



## HYDRA DS

self-cleaning filters  
with rotational  
connection group

Range of self-cleaning filters,  
performing all features  
of the standard HYDRA range,  
provided with the new  
360° rotational connection group  
for easy connection  
to horizontal or vertical pipes

# HYDRA DS SELF-CLEANING FILTERS

WITH ROTATIONAL CONNECTION GROUP

ACCESSORIES ON DEMAND



Housings HYDRA DS fit to **EXCLUSIVE HYDRA FILTER CARTRIDGES.**

**SX** cartridges with antimicrobial flat seal.



**RAH**  
stainless steel net cartridge, filtration at 90 micron.  
CODE RA5000020



**RLH**  
plastic net cartridge, filtration at 90 micron.  
CODE RA5000010



**RSH**  
pleated plastic net cartridge, filtration at 50 micron.  
CODE RA5000040



All cartridges are provided with dedicated **stainless steel AISI 302 cartridge spring.**  
CODE RE7120040



**MP** models with plastic connections at 3/4" and 1"



**HYDRA DS MP models** come complete with 3/4" and 1" nipples all together in the package

MP group is made of a special high-resistance plastic, resulting from the most advanced research and development in materials and production processes.



**MO** models with brass connections at 3/4" or 1"



brass hose-holder CODE RE7120026



-KIT AUTO- CODE RE7120024  
automatic discharge kit (see pages 186-187)



-LUBRIKIT- single-dose lubricant for housing o-ring  
CODE RE9020650

## ACCESSORIES INCLUDED

### DISCHARGE KIT



brass discharge ball-valve with gasket



plastic hose-holder



drain funnel

In compliance with the European Standard UNI EN 1717/2002: designed to prevent back-flow contamination by making all elements downstream the discharge vent to atmosphere (protection unit symbol: DC)



-X- spanner

## CERTIFICATIONS



Housings are tested and certified under the most stringent procedures worldwide, in compliance with DM 25 (Italy), with the sanitary certification EAC/ Ghostreghstrazia (Russia) and WaterMark (Australia).





HYDRA DS

HYDRA DS

FILTER MODEL

MO 3/4"

IN / OUT ROTATIONAL GROUP TYPE

RLH 90 mcr

FILTER CARTRIDGE

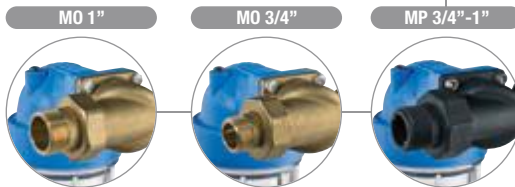

MO 1"

MO 3/4"

MP 3/4"-1"



RLH 90 mcr

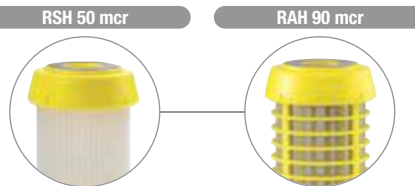

RSH 50 mcr

RAH 90 mcr

SYMBOLS LEGEND



For domestic use



For technical and industrial use



Filter housings made in PET, a highly recyclable plastic, are manufactured with a proprietary procedure saving up to 60% of energy in injection molding compared with standard plastics. That

is one of Atlas Filtri commitments to comply with Kyoto Treaty for the reduction of green house gas (CO<sub>2</sub>) emissions in the atmosphere.

FLOW RATE vs PRESSURE DROP  $\Delta p$

Testing mode: 20°C, 3 BAR

RSH — red line  
RLH — green line  
RAH — blue line

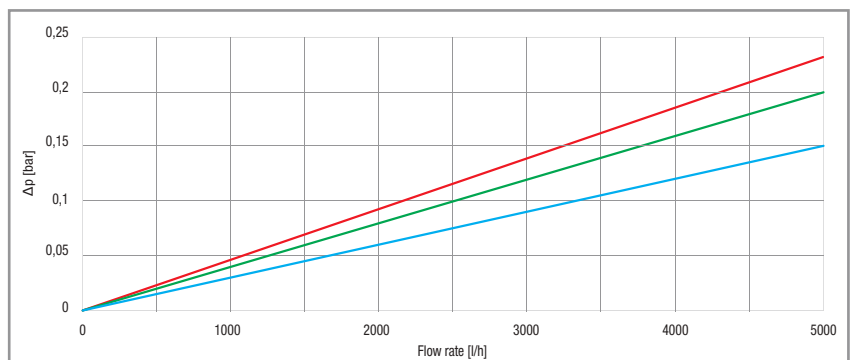





# HYDRA DS

## WORKING CONDITIONS

Max working pressure \_\_\_\_\_ 8 bar (116 psi)  
 Min working pressure \_\_\_\_\_ 1,8 bar (26 psi)  
 Max working temperature \_\_\_\_\_ 45°C (113°F)  
 Min working temperature \_\_\_\_\_ 4°C (39,2°F)

## SPECIFICATIONS

Non-toxic materials, suitable for drinking water.  
 Head: reinforced polypropylene.  
 Bowl: PET.  
 O-rings: EPDM.  
 Breather-valve: body polypropylene, o-ring EPDM.  
 MP plastic rotational connection group: reinforced nylon.  
 MO brass rotational connection group: CW 614 N brass.  
 Rotational connection group gaskets: NBR.  
 Discharge ball-valve: CW 617 N brass nickel plated.  
 Drain funnel: reinforced polypropylene.

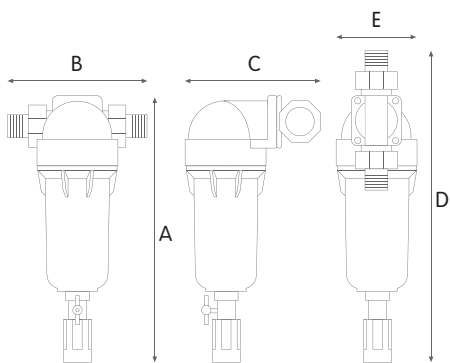

**DRAIN FUNNEL**  
 Back-flow preventing device  
 UNI EN 1717-11/2002

## HYDRA DS MP single-stage self-cleaning filters with plastic rotational group

### PLASTIC ROTATIONAL GROUP

CODE	MODEL	NOMINAL FILTRATION MICRON	IN/OUT	FLOW RATE l/h	DIMENSIONS mm				
					A	B	C	D	E
RA6000601	HYDRA DS MP 3/4" - 1" RLH 90 mcr	90	3/4" - 1"	5000	428	170	168	479	107
RA6000602	HYDRA DS MP 3/4" - 1" RAH 90 mcr	90	3/4" - 1"	5000	428	170	168	479	107
RA6000603	HYDRA DS MP 3/4" - 1" RSH 50 mcr	50	3/4" - 1"	5000	428	170	168	479	107



## HYDRA DS MO single-stage self-cleaning filters with brass rotational group

### BRASS ROTATIONAL GROUP

CODE	MODEL	NOMINAL FILTRATION MICRON	IN/OUT	FLOW RATE l/h	DIMENSIONS mm				
					A	B	C	D	E
RA6000604	HYDRA DS MO 3/4" RLH 90 mcr	90	3/4"	4000	428	170	168	479	107
RA6000605	HYDRA DS MO 1" RLH 90 mcr	90	1"	5000	428	170	168	479	107
RA6000606	HYDRA DS MO 3/4" RAH 90 mcr	90	3/4"	4000	428	170	168	479	107
RA6000607	HYDRA DS MO 1" RAH 90 mcr	90	1"	5000	428	170	168	479	107
RA6000608	HYDRA DS MO 3/4" RSH 50 mcr	50	3/4"	4000	428	170	168	479	107
RA6000609	HYDRA DS MO 1" RSH 50 mcr	50	1"	5000	428	170	168	479	107





SELF-CLEANING  
FILTERS

# HYDRA DUO and TRIO

multi-stage self-cleaning filters

Exclusive multi-stage filters with self-cleaning pre-filter,  
for dual and triple stage water filtration and treatment

# HYDRA DUO and TRIO

FOR CARTRIDGES SX and BX

**Second and third stages housings fit to both standard SX (DOE) cartridges and to exclusive BX cartridges.**

The full range of Atlas Filtri® SX and BX cartridges is suitable to Hydra multi-stage housings and provides the widest range of water filtration and treatment units.



**SX** cartridges with standard flat seals.

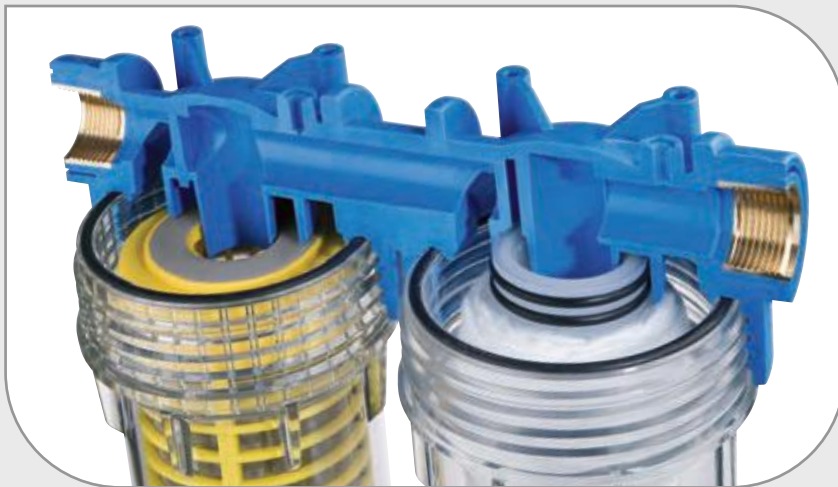

**BX** cartridges with 45 mm double o-ring collar. Quick-fit connection for a perfect tightening.

## FLOW RATE vs PRESSURE DROP $\Delta p$

Testing mode: 20°C, 3 BAR

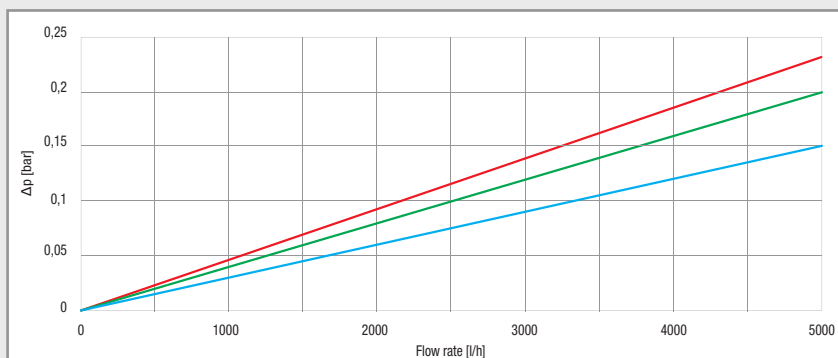

RSH —  
RLH —  
RAH —

## ACCESSORIES ON DEMAND



3/4" plastic nipple  
with o-ring  
CODE LB7404012



3/4" / 1" brass nipples with o-ring (pair)  
CODE RB7404001 / CODE RB7404002



-LUBRIKIT- single-dose lubricant for housing o-ring  
CODE RE9020650



-KIT AUTO- CODE RE7120024  
automatic discharge kit (see pages 186-187)

## ACCESSORIES INCLUDED



-X- spanner

-DUO- wall bracket



-TRIO- wall bracket

## DISCHARGE KIT



brass discharge  
ball-valve with gasket

plastic  
hose-holder



drain funnel

In compliance with the European Standard UNI EN 1717/2002: designed to prevent back-flow contamination by making all elements downstream the discharge vent to atmosphere (protection unit symbol: DC)



Filterfit - cartridge centering device



DUO



TRIO

HYDRA

FILTER MODEL

DUO

VERSION

3/4"

IN / OUT

1/2"

3/4"

1"

RAH

PREFILTER CARTRIDGE

RAH



RLH



RSH



OT

THREADS TYPE

OT - BRASS BSP \*

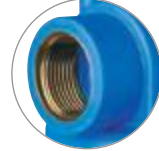

IN - PLASTIC BSP \*

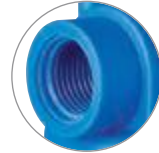

NPT IN - PLASTIC NPT \*\*

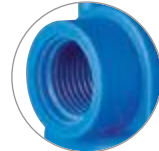

Exclusive HYDRA filter cartridges with antimicrobial flat seal for the self-cleaning stage.

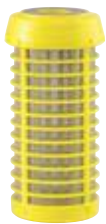

RAH

stainless steel net cartridge, filtration at 90 micron.  
CODE RA5000020



RLH

plastic net cartridge, filtration at 90 micron.  
CODE RA5000010



RSH

pleated plastic net cartridge, filtration at 50 micron.  
CODE RA5000040



All cartridges are provided with dedicated **stainless steel AISI 302 cartridge spring**.  
CODE RE7120040

CERTIFICATIONS



Housings are tested and certified under the most stringent procedures worldwide, in compliance with DM 25 (Italy), with the sanitary certification ACS (France), EAC/Ghostreghistrizia (Russia) and WaterMark (Australia).

SYMBOLS LEGEND



For domestic use



For technical and industrial use



Filter housings made in PET, a highly recyclable plastic, are manufactured with a proprietary procedure saving up to 60% of energy in injection molding compared with standard plastics. That is one of Atlas Filtri commitments to comply with Kyoto Treaty for the reduction of green house gas (CO<sub>2</sub>) emissions in the atmosphere.

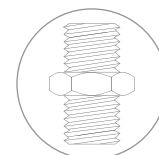

\* BSP parallel (cylindrical) ISO 228

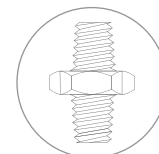

\*\* NPT tapered (conical) ANSI/ASME B1.20.1





# HYDRA DUO

## WORKING CONDITIONS

Max working pressure:  
 BSP versions \_\_\_\_\_ 8 bar (116 psi)  
 NPT versions \_\_\_\_\_ 8,6 bar (125 psi)  
 Min working pressure \_\_\_\_\_ 1,8 bar (26 psi)  
 Max working temperature \_\_\_\_\_ 45°C (113°F)  
 Min working temperature \_\_\_\_\_ 4°C (39,2°F)

## SPECIFICATIONS

Non-toxic materials, suitable for drinking water.  
 Head: reinforced polypropylene.  
 Bowl: PET.  
 O-rings: EPDM.  
 Breather-valve: body stainless steel, o-ring EPDM.  
 IN/OUT brass threads: CW 617 N brass.  
 Discharge ball-valve: CW 617 N brass nickel plated.  
 Drain funnel: reinforced polypropylene.

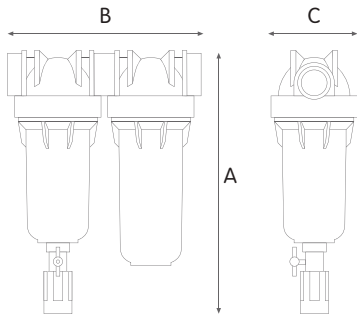

**DRAIN FUNNEL**  
 Back-flow preventing device  
 UNI EN 1717-11/2002



## HYDRA DUO RLH multi-stage self-cleanig filters

### HOUSINGS WITH BRASS BSP THREADS

CODE	MODEL	SELF-CLEANING NOMINAL FILTRATION MICRON	IN/OUT	DIMENSIONS mm		
				A	B	C
RA6096143	HYDRA DUO RLH 1/2" OT	90	1/2"	390	228	107
RA6096153	HYDRA DUO RLH 3/4" OT	90	3/4"	390	228	107
RA6096163	HYDRA DUO RLH 1" OT	90	1"	390	228	107



### HOUSINGS WITH PLASTIC BSP THREADS

CODE	MODEL	SELF-CLEANING NOMINAL FILTRATION MICRON	IN/OUT	DIMENSIONS mm		
				A	B	C
RA6096142	HYDRA DUO RLH 1/2" IN	90	1/2"	390	228	107
RA6096152	HYDRA DUO RLH 3/4" IN	90	3/4"	390	228	107
RA6096162	HYDRA DUO RLH 1" IN	90	1"	390	228	107

### HOUSINGS WITH PLASTIC NPT THREADS

CODE	MODEL	SELF-CLEANING NOMINAL FILTRATION MICRON	IN/OUT	DIMENSIONS mm		
				A	B	C
RA6096151	HYDRA DUO RLH 3/4" NPT IN	90	3/4"	390	228	107
RA6096161	HYDRA DUO RLH 1" NPT IN	90	1"	390	228	107

Some items in the list are subject to minimum order quantities and/or to longer delivery term.

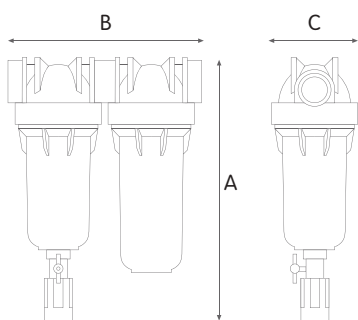

**WORKING CONDITIONS**

Max working pressure:  
 BSP versions \_\_\_\_\_ 8 bar (116 psi)  
 NPT versions \_\_\_\_\_ 8,6 bar (125 psi)  
 Min working pressure \_\_\_\_\_ 1,8 bar (26 psi)  
 Max working temperature \_\_\_\_\_ 45°C (113°F)  
 Min working temperature \_\_\_\_\_ 4°C (39,2°F)



**DRAIN FUNNEL**  
 Back-flow preventing device  
 UNI EN 1717-11/2002

**SPECIFICATIONS**

Non-toxic materials, suitable for drinking water.  
 Head: reinforced polypropylene.  
 Bowl: PET.  
 O-rings: EPDM.  
 Breather-valve: body stainless steel, o-ring EPDM.  
 IN/OUT brass threads: CW 617 N brass.  
 Discharge ball-valve: CW 617 N brass nickel plated.  
 Drain funnel: reinforced polypropylene.

**HYDRA DUO RAH multi-stage self-cleanig filters**

**HOUSINGS WITH BRASS BSP THREADS**

CODE	MODEL	SELF-CLEANING NOMINAL FILTRATION MICRON	IN/OUT	DIMENSIONS mm		
				A	B	C
RA6096213	HYDRA DUO RAH 1/2" OT	90	1/2"	390	228	107
RA6096223	HYDRA DUO RAH 3/4" OT	90	3/4"	390	228	107
RA6096233	HYDRA DUO RAH 1" OT	90	1"	390	228	107



**HOUSINGS WITH PLASTIC BSP THREADS**

CODE	MODEL	SELF-CLEANING NOMINAL FILTRATION MICRON	IN/OUT	DIMENSIONS mm		
				A	B	C
RA6096212	HYDRA DUO RAH 1/2" IN	90	1/2"	390	228	107
RA6096222	HYDRA DUO RAH 3/4" IN	90	3/4"	390	228	107
RA6096232	HYDRA DUO RAH 1" IN	90	1"	390	228	107



**HOUSINGS WITH PLASTIC NPT THREADS**

CODE	MODEL	SELF-CLEANING NOMINAL FILTRATION MICRON	IN/OUT	DIMENSIONS mm		
				A	B	C
RA6096221	HYDRA DUO RAH 3/4" NPT IN	90	3/4"	390	228	107
RA6096231	HYDRA DUO RAH 1" NPT IN	90	1"	390	228	107

SELF-CLEANING  
 FILTERS

Some items in the list are subject to minimum order quantities and/or to longer delivery term.



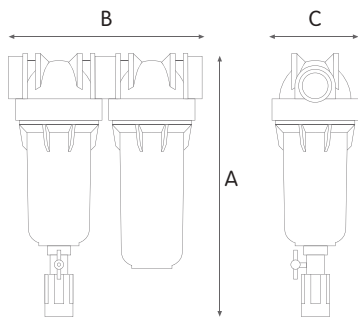

**WORKING CONDITIONS**

Max working pressure:  
 BSP versions \_\_\_\_\_ 8 bar (116 psi)  
 NPT versions \_\_\_\_\_ 8,6 bar (125 psi)  
 Min working pressure \_\_\_\_\_ 1,8 bar (26 psi)  
 Max working temperature \_\_\_\_\_ 45°C (113°F)  
 Min working temperature \_\_\_\_\_ 4°C (39,2°F)

**SPECIFICATIONS**

Non-toxic materials, suitable for drinking water.  
 Head: reinforced polypropylene.  
 Bowl: PET.  
 O-rings: EPDM.  
 Breather-valve: body stainless steel, o-ring EPDM.  
 IN/OUT brass threads: CW 617 N brass.  
 Discharge ball-valve: CW 617 N brass nickel plated.  
 Drain funnel: reinforced polypropylene.



**DRAIN FUNNEL**  
 Back-flow preventing device  
 UNI EN 1717-11/2002



**HYDRA DUO RSH multi-stage self-cleaning filters**

**HOUSINGS WITH BRASS BSP THREADS**

CODE	MODEL	SELF-CLEANING NOMINAL FILTRATION MICRON	IN/OUT	DIMENSIONS mm		
				A	B	C
RA6096171	HYDRA DUO RSH 1/2" OT	50	1/2"	390	228	107
RA6096172	HYDRA DUO RSH 3/4" OT	50	3/4"	390	228	107
RA6096173	HYDRA DUO RSH 1" OT	50	1"	390	228	107



**HOUSINGS WITH PLASTIC BSP THREADS**

CODE	MODEL	SELF-CLEANING NOMINAL FILTRATION MICRON	IN/OUT	DIMENSIONS mm		
				A	B	C
RA6096175	HYDRA DUO RSH 1/2" IN	50	1/2"	390	228	107
RA6096182	HYDRA DUO RSH 3/4" IN	50	3/4"	390	228	107
RA6096192	HYDRA DUO RSH 1" IN	50	1"	390	228	107

**HOUSINGS WITH PLASTIC NPT THREADS**

CODE	MODEL	SELF-CLEANING NOMINAL FILTRATION MICRON	IN/OUT	DIMENSIONS mm		
				A	B	C
RA6096181	HYDRA DUO RSH 3/4" NPT IN	50	3/4"	390	228	107
RA6096191	HYDRA DUO RSH 1" NPT IN	50	1"	390	228	107

Some items in the list are subject to minimum order quantities and/or to longer delivery term.



# HYDRA TRIO

## WORKING CONDITIONS

Max working pressure:  
 BSP versions \_\_\_\_\_ 8 bar (116 psi)  
 NPT versions \_\_\_\_\_ 8,6 bar (125 psi)  
 Min working pressure \_\_\_\_\_ 1,8 bar (26 psi)  
 Max working temperature \_\_\_\_\_ 45°C (113°F)  
 Min working temperature \_\_\_\_\_ 4°C (39,2°F)

## SPECIFICATIONS

Non-toxic materials, suitable for drinking water.  
 Head: reinforced polypropylene.  
 Bowl: PET.  
 O-rings: EPDM.  
 Breather-valve: body stainless steel, o-ring EPDM.  
 IN/OUT brass threads: CW 617 N brass.  
 Discharge ball-valve: CW 617 N brass nickel plated.  
 Drain funnel: reinforced polypropylene.

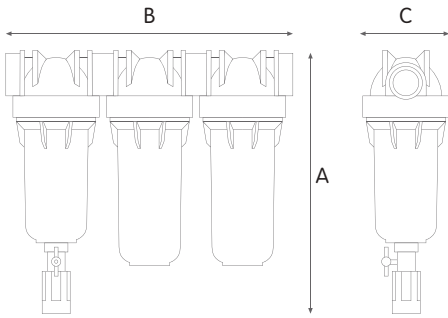

**DRAIN FUNNEL**  
 Back-flow preventing device  
 UNI EN 1717-11/2002



## HYDRA TRIO RLH multi-stage self-cleaning filters

### HOUSINGS WITH BRASS BSP THREADS

CODE	MODEL	SELF-CLEANING NOMINAL FILTRATION MICRON	IN/OUT	DIMENSIONS mm		
				A	B	C
RA6095143	HYDRA TRIO RLH 1/2" OT	90	1/2"	390	336	107
RA6095153	HYDRA TRIO RLH 3/4" OT	90	3/4"	390	336	107
RA6095163	HYDRA TRIO RLH 1" OT	90	1"	390	336	107



### HOUSINGS WITH PLASTIC BSP THREADS

CODE	MODEL	SELF-CLEANING NOMINAL FILTRATION MICRON	IN/OUT	DIMENSIONS mm		
				A	B	C
RA6095142	HYDRA TRIO RLH 1/2" IN	90	1/2"	390	336	107
RA6095152	HYDRA TRIO RLH 3/4" IN	90	3/4"	390	336	107
RA6095162	HYDRA TRIO RLH 1" IN	90	1"	390	336	107

### HOUSINGS WITH PLASTIC NPT THREADS

CODE	MODEL	SELF-CLEANING NOMINAL FILTRATION MICRON	IN/OUT	DIMENSIONS mm		
				A	B	C
RA6095141	HYDRA TRIO RLH 3/4" NPT IN	90	3/4"	390	336	107
RA6095151	HYDRA TRIO RLH 1" NPT IN	90	1"	390	336	107

SELF-CLEANING  
 FILTERS

Some items in the list are subject to minimum order quantities and/or to longer delivery term.

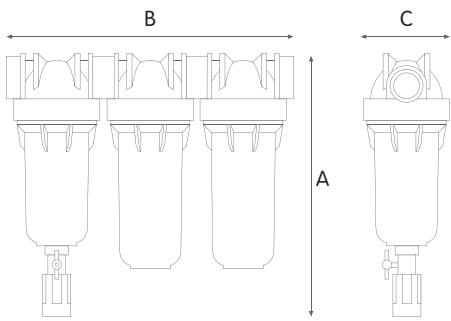

**WORKING CONDITIONS**

Max working pressure:  
 BSP versions \_\_\_\_\_ 8 bar (116 psi)  
 NPT versions \_\_\_\_\_ 8,6 bar (125 psi)  
 Min working pressure \_\_\_\_\_ 1,8 bar (26 psi)  
 Max working temperature \_\_\_\_\_ 45°C (113°F)  
 Min working temperature \_\_\_\_\_ 4°C (39,2°F)

**SPECIFICATIONS**

Non-toxic materials, suitable for drinking water.  
 Head: reinforced polypropylene.  
 Bowl: PET.  
 O-rings: EPDM.  
 Breather-valve: body stainless steel, o-ring EPDM.  
 IN/OUT brass threads: CW 617 N brass.  
 Discharge ball-valve: CW 617 N brass nickel plated.  
 Drain funnel: reinforced polypropylene.



**DRAIN FUNNEL**  
 Back-flow preventing device  
 UNI EN 1717-11/2002



**HYDRA TRIO RAH multi-stage self-cleaning filters**

**HOUSINGS WITH BRASS BSP THREADS**

CODE	MODEL	SELF-CLEANING NOMINAL FILTRATION MICRON	IN/OUT	DIMENSIONS mm		
				A	B	C
RA6095113	HYDRA TRIO RAH 1/2" OT	90	1/2"	390	336	107
RA6095223	HYDRA TRIO RAH 3/4" OT	90	3/4"	390	336	107
RA6095233	HYDRA TRIO RAH 1" OT	90	1"	390	336	107



**HOUSINGS WITH PLASTIC BSP THREADS**

CODE	MODEL	SELF-CLEANING NOMINAL FILTRATION MICRON	IN/OUT	DIMENSIONS mm		
				A	B	C
RA6095112	HYDRA TRIO RAH 1/2" IN	90	1/2"	390	336	107
RA6095222	HYDRA TRIO RAH 3/4" IN	90	3/4"	390	336	107
RA6095232	HYDRA TRIO RAH 1" IN	90	1"	390	336	107

**HOUSINGS WITH PLASTIC NPT THREADS**

CODE	MODEL	SELF-CLEANING NOMINAL FILTRATION MICRON	IN/OUT	DIMENSIONS mm		
				A	B	C
RA6095221	HYDRA TRIO RAH 3/4" NPT IN	90	3/4"	390	336	107
RA6095231	HYDRA TRIO RAH 1" NPT IN	90	1"	390	336	107

Some items in the list are subject to minimum order quantities and/or to longer delivery term.

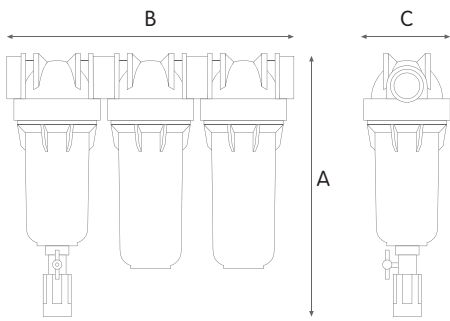

**WORKING CONDITIONS**

Max working pressure:  
 BSP versions \_\_\_\_\_ 8 bar (116 psi)  
 NPT versions \_\_\_\_\_ 8,6 bar (125 psi)  
 Min working pressure \_\_\_\_\_ 1,8 bar (26 psi)  
 Max working temperature \_\_\_\_\_ 45°C (113°F)  
 Min working temperature \_\_\_\_\_ 4°C (39,2°F)



**DRAIN FUNNEL**  
 Back-flow preventing device  
 UNI EN 1717-11/2002

**SPECIFICATIONS**

Non-toxic materials, suitable for drinking water.  
 Head: reinforced polypropylene.  
 Bowl: PET.  
 O-rings: EPDM.  
 Breather-valve: body stainless steel, o-ring EPDM.  
 IN/OUT brass threads: CW 617 N brass.  
 Discharge ball-valve: CW 617 N brass nickel plated.  
 Drain funnel: reinforced polypropylene.



**HYDRA TRIO RSH multi-stage self-cleaning filters**

**HOUSINGS WITH BRASS BSP THREADS**

CODE	MODEL	SELF-CLEANING NOMINAL FILTRATION MICRON	IN/OUT	DIMENSIONS mm		
				A	B	C
RA6095173	HYDRA TRIO RSH 1/2" OT	50	1/2"	390	336	107
RA6095183	HYDRA TRIO RSH 3/4" OT	50	3/4"	390	336	107
RA6095193	HYDRA TRIO RSH 1" OT	50	1"	390	336	107



**HOUSINGS WITH PLASTIC BSP THREADS**

CODE	MODEL	SELF-CLEANING NOMINAL FILTRATION MICRON	IN/OUT	DIMENSIONS mm		
				A	B	C
RA6095172	HYDRA TRIO RSH 1/2" IN	50	1/2"	390	336	107
RA6095182	HYDRA TRIO RSH 3/4" IN	50	3/4"	390	336	107
RA6095192	HYDRA TRIO RSH 1" IN	50	1"	390	336	107

**HOUSINGS WITH PLASTIC NPT THREADS**

CODE	MODEL	SELF-CLEANING NOMINAL FILTRATION MICRON	IN/OUT	DIMENSIONS mm		
				A	B	C
RA6095181	HYDRA TRIO RSH 3/4" NPT IN	50	3/4"	390	336	107
RA6095191	HYDRA TRIO RSH 1" NPT IN	50	1"	390	336	107

SELF-CLEANING  
 FILTERS

Some items in the list are subject to minimum order quantities and/or to longer delivery term.





SELF-CLEANING  
FILTERS

# HYDRA RAINMASTER

multi-stage self-cleaning filters

Range of multi-stage self-cleaning filters especially designed for the filtration and treatment of rainwater, in re-cycling applications



# HYDRA RAINMASTER

FOR CARTRIDGES SX and BX

**Second and third stages housings fit to both standard SX (DOE) cartridges and to exclusive BX cartridges.**

The full range of Atlas Filtri® SX and BX cartridges is suitable to Hydra multi-stage housings and provides the widest range of water filtration and treatment units.



**SX** cartridges with antimicrobial flat seals. Standard seals for CB EC cartridge.

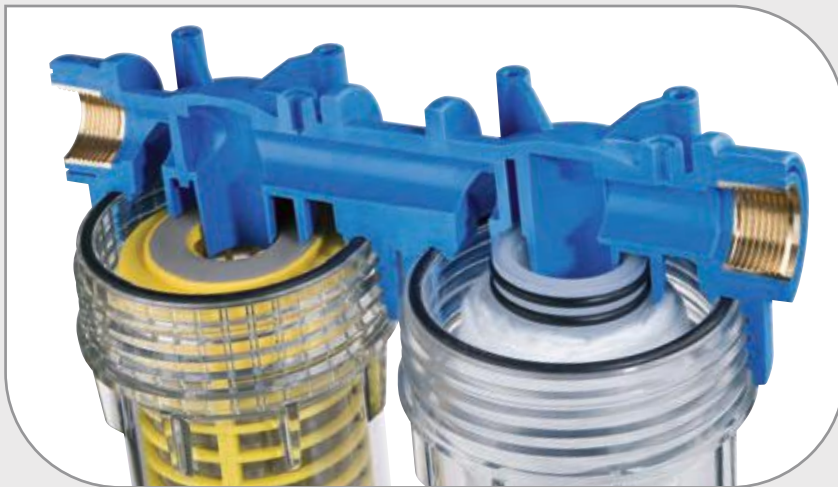

**BX** cartridges with 45 mm double o-ring collar. Quick-fit connection for a perfect tightening.

## FLOW RATE vs PRESSURE DROP $\Delta p$

Testing mode: 20°C, 3 BAR

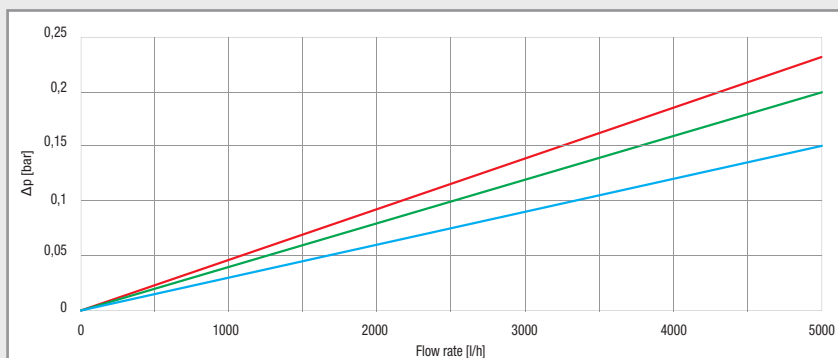

RSH —  
RLH —  
RAH —

## ACCESSORIES INCLUDED



-X- spanner

-DUO- wall bracket

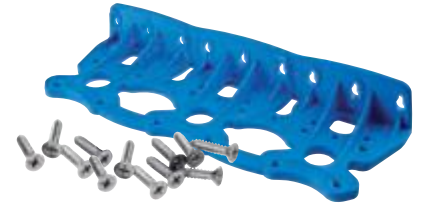

-TRIO- wall bracket

## DISCHARGE KIT



brass discharge  
ball-valve with gasket

plastic  
hose-holder



drain funnel

In compliance with the European Standard UNI EN 1717/2002: designed to prevent back-flow contamination by making all elements downstream the discharge vent to atmosphere (protection unit symbol: DC)



Filterfit - cartridge centering device

## ACCESSORIES ON DEMAND



3/4" plastic nipple  
with o-ring  
CODE LB7404012

3/4" / 1" brass nipples with o-ring (pair)  
CODE RB7404001 / CODE RB7404002



-KIT AUTO- CODE RE7120024  
automatic discharge kit (see pages 186-187)



-UV 1200- CODE EA3500003 (see page 321)

-UV 2800- CODE EA3500004 (see page 321)



DUO

TRIO

# HYDRA RAINMASTER

FILTER MODEL

DUO

VERSION

3/4"

IN / OUT

1/2"

3/4"

1"

RAH

PREFILTER CARTRIDGE

CB EC

POSTFILTER CARTRIDGE

CB EC - CARBON BLOCK

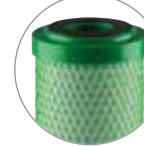

LA - GRANULAR ACTIVATED CARBON



OT

THREADS TYPE

OT - BRASS BSP \*

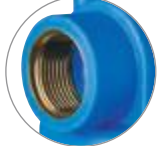

IN - PLASTIC BSP \*

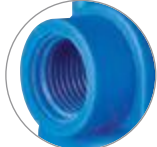

NPT IN - PLASTIC NPT \*\*

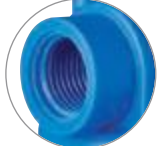

Exclusive HYDRA RAINMASTER filter cartridge with antimicrobial flat seal for the self-cleaning stage.



## RAH

stainless steel net cartridge, filtration at 90 micron.  
CODE RA5000020



With dedicated stainless steel AISI 302 cartridge spring.  
CODE RE7120040

### CERTIFICATIONS



Housings are tested and certified under the most stringent procedures worldwide, in compliance with DM 25 (Italy), with the sanitary certification ACS (France), EAC/Ghostreghistrizia (Russia) and WaterMark (Australia).

### SYMBOLS LEGEND



For domestic use



For technical and industrial use



Filter housings made in PET, a highly recyclable plastic, are manufactured with a proprietary procedure saving up to 60% of energy in injection molding compared with standard plastics. That is one of Atlas Filtri commitments to comply with Kyoto Treaty for the reduction of green house gas (CO<sub>2</sub>) emissions in the atmosphere.



-LUBRIKIT- single-dose lubricant for housing o-ring  
CODE RE9020650

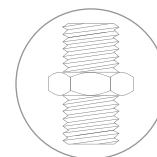

\* BSP parallel (cylindrical) ISO 228

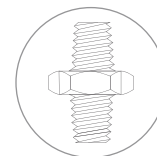

\*\* NPT tapered (conical) ANSI/ASME B1.20.1



# HYDRA RAINMASTER DUO

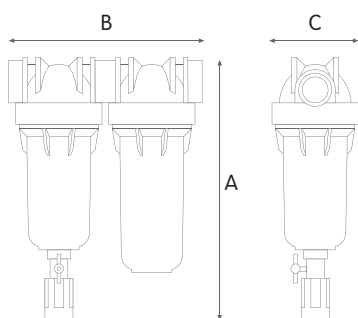

## WORKING CONDITIONS

Max working pressure:  
 BSP versions \_\_\_\_\_ 8 bar (116 psi)  
 NPT versions \_\_\_\_\_ 8,6 bar (125 psi)  
 Min working pressure \_\_\_\_\_ 1,8 bar (26 psi)  
 Max working temperature \_\_\_\_\_ 45°C (113°F)  
 Min working temperature \_\_\_\_\_ 4°C (39,2°F)

## SPECIFICATIONS

Non-toxic materials, suitable for drinking water.  
 Head: reinforced polypropylene.  
 Bowl: PET.  
 O-rings: EPDM.  
 Breather-valve: body stainless steel, o-ring EPDM.  
 IN/OUT brass threads: CW 617 N brass.  
 Discharge ball-valve: CW 617 N brass nickel plated.  
 Drain funnel: reinforced polypropylene.



**DRAIN FUNNEL**  
 Back-flow preventing device  
 UNI EN 1717-11/2002

## HYDRA RAINMASTER DUO RAH with carbon block cartridge

### HOUSINGS WITH BRASS BSP THREADS

CODE	MODEL	SELF CLEANING NOMINAL FILTRATION MICRON	POST CARTRIDGE NOMINAL FILTRATION MICRON	IN/OUT	FLOW RATE l/h	DIMENSIONS mm		
						A	B	C
RA6096114	HYDRA RAINMASTER DUO RAH CB/EC 1/2" OT	90	10	1/2"	3500	390	228	107
RA6096124	HYDRA RAINMASTER DUO RAH CB/EC 3/4" OT	90	10	3/4"	5000	390	228	107
RA6096134	HYDRA RAINMASTER DUO RAH CB/EC 1" OT	90	10	1"	5700	390	228	107



### HOUSINGS WITH PLASTIC BSP THREADS

CODE	MODEL	SELF CLEANING NOMINAL FILTRATION MICRON	POST CARTRIDGE NOMINAL FILTRATION MICRON	IN/OUT	FLOW RATE l/h	DIMENSIONS mm		
						A	B	C
RA6096115	HYDRA RAINMASTER DUO RAH CB/EC 1/2" IN	90	10	1/2"	3500	390	228	107
RA6096125	HYDRA RAINMASTER DUO RAH CB/EC 3/4" IN	90	10	3/4"	5000	390	228	107
RA6096135	HYDRA RAINMASTER DUO RAH CB/EC 1" IN	90	10	1"	5700	390	228	107



### HOUSINGS WITH PLASTIC NPT THREADS

CODE	MODEL	SELF CLEANING NOMINAL FILTRATION MICRON	POST CARTRIDGE NOMINAL FILTRATION MICRON	IN/OUT	FLOW RATE l/h	DIMENSIONS mm		
						A	B	C
RA6096126	HYDRA RAINMASTER DUO RAH CB/EC 3/4" NPT IN	90	10	3/4"	5000	390	228	107
RA6096136	HYDRA RAINMASTER DUO RAH CB/EC 1" NPT IN	90	10	1"	5700	390	228	107

For carbon block cartridge specifications see CB EC CTO on page 261

## VARIANTS AVAILABLE ON MINIMUM QUANTITY:

- HYDRA RAINMASTER DUO with RLH or RSH prefilter cartridges.

Some items in the list are subject to minimum order quantities and/or to longer delivery term.

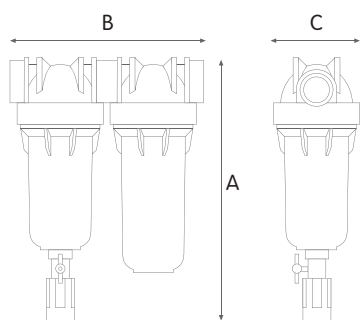

**WORKING CONDITIONS**

Max working pressure:  
 BSP versions \_\_\_\_\_ 8 bar (116 psi)  
 NPT versions \_\_\_\_\_ 8,6 bar (125 psi)  
 Min working pressure \_\_\_\_\_ 1,8 bar (26 psi)  
 Max working temperature \_\_\_\_\_ 45°C (113°F)  
 Min working temperature \_\_\_\_\_ 4°C (39,2°F)

**SPECIFICATIONS**

Non-toxic materials, suitable for drinking water.  
 Head: reinforced polypropylene.  
 Bowl: PET.  
 O-rings: EPDM.  
 Breather-valve: body stainless steel, o-ring EPDM.  
 IN/OUT brass threads: CW 617 N brass.  
 Discharge ball-valve: CW 617 N brass nickel plated.  
 Drain funnel: reinforced polypropylene.



**DRAIN FUNNEL**  
 Back-flow preventing device  
 UNI EN 1717-11/2002

**HYDRA RAINMASTER DUO RAH with GAC cartridge**

**HOUSINGS WITH BRASS BSP THREADS**

CODE	MODEL	SELF CLEANING NOMINAL FILTRATION MICRON	POST CARTRIDGE NOMINAL FILTRATION MICRON	IN/OUT	FLOW RATE l/h	DIMENSIONS mm		
						A	B	C
RA6096214	HYDRA RAINMASTER DUO RAH LA 1/2" OT	90	-	1/2"	1900	390	228	107
RA6096224	HYDRA RAINMASTER DUO RAH LA 3/4" OT	90	-	3/4"	2600	390	228	107
RA6096234	HYDRA RAINMASTER DUO RAH LA 1" OT	90	-	1"	2900	390	228	107

**HOUSINGS WITH PLASTIC BSP THREADS**

CODE	MODEL	SELF CLEANING NOMINAL FILTRATION MICRON	POST CARTRIDGE NOMINAL FILTRATION MICRON	IN/OUT	FLOW RATE l/h	DIMENSIONS mm		
						A	B	C
RA6096215	HYDRA RAINMASTER DUO RAH LA 1/2" IN	90	-	1/2"	1900	390	228	107
RA6096225	HYDRA RAINMASTER DUO RAH LA 3/4" IN	90	-	3/4"	2600	390	228	107
RA6096230	HYDRA RAINMASTER DUO RAH LA 1" IN	90	-	1"	2900	390	228	107

**HOUSINGS WITH PLASTIC NPT THREADS**

CODE	MODEL	SELF CLEANING NOMINAL FILTRATION MICRON	POST CARTRIDGE NOMINAL FILTRATION MICRON	IN/OUT	FLOW RATE l/h	DIMENSIONS mm		
						A	B	C
RA6096226	HYDRA RAINMASTER DUO RAH LA 3/4" NPT IN	90	-	3/4"	2600	390	228	107
RA6096236	HYDRA RAINMASTER DUO RAH LA 1" NPT IN	90	-	1"	2900	390	228	107

For GAC cartridge specifications see LA at page 253

**VARIANTS AVAILABLE ON MINIMUM QUANTITY:**

- HYDRA RAINMASTER DUO with RLH or RSH prefilter cartridges.

Some items in the list are subject to minimum order quantities and/or to longer delivery term.

SELF-CLEANING FILTERS





# HYDRA RAINMASTER TRIO

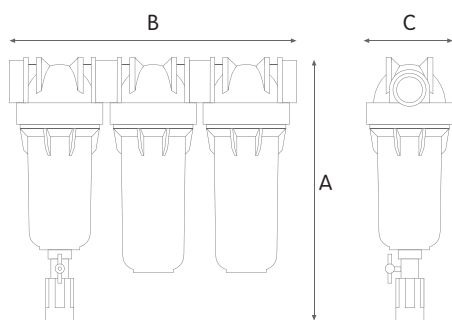

## WORKING CONDITIONS

Max working pressure:  
 BSP versions \_\_\_\_\_ 8 bar (116 psi)  
 NPT versions \_\_\_\_\_ 8,6 bar (125 psi)  
 Min working pressure \_\_\_\_\_ 1,8 bar (26 psi)  
 Max working temperature \_\_\_\_\_ 45°C (113°F)  
 Min working temperature \_\_\_\_\_ 4°C (39,2°F)

## SPECIFICATIONS

Non-toxic materials, suitable for drinking water.  
 Head: reinforced polypropylene.  
 Bowl: PET.  
 O-rings: EPDM.  
 Breather-valve: body stainless steel, o-ring EPDM.  
 IN/OUT brass threads: CW 617 N brass.  
 Discharge ball-valve: CW 617 N brass nickel plated.  
 Drain funnel: reinforced polypropylene.



**DRAIN FUNNEL**  
 Back-flow preventing device  
 UNI EN 1717-11/2002

## HYDRA RAINMASTER TRIO RAH with carbon block cartridge

### HOUSINGS WITH BRASS BSP THREADS

CODE	MODEL	SELF CLEANING NOMINAL FILTRATION MICRON	SEDIMENT NOMINAL FILTRATION MICRON	POST CARTRIDGE NOMINAL FILTRATION MICRON	IN/OUT	FLOW RATE l/h	DIMENSIONS mm		
							A	B	C
RA6095114	HYDRA RAINMASTER TRIO RAH CB/EC 1/2" OT	90	25	10	1/2"	3500	390	336	107
RA6095124	HYDRA RAINMASTER TRIO RAH CB/EC 3/4" OT	90	25	10	3/4"	4800	390	336	107
RA6095134	HYDRA RAINMASTER TRIO RAH CB/EC 1" OT	90	25	10	1"	5500	390	336	107



### HOUSINGS WITH PLASTIC BSP THREADS

CODE	MODEL	SELF CLEANING NOMINAL FILTRATION MICRON	SEDIMENT NOMINAL FILTRATION MICRON	POST CARTRIDGE NOMINAL FILTRATION MICRON	IN/OUT	FLOW RATE l/h	DIMENSIONS mm		
							A	B	C
RA6095115	HYDRA RAINMASTER TRIO RAH CB/EC 1/2" IN	90	25	10	1/2"	3500	390	336	107
RA6095120	HYDRA RAINMASTER TRIO RAH CB/EC 3/4" IN	90	25	10	3/4"	4800	390	336	107
RA6095135	HYDRA RAINMASTER TRIO RAH CB/EC 1" IN	90	25	10	1"	5500	390	336	107



### HOUSINGS WITH PLASTIC NPT THREADS

CODE	MODEL	SELF CLEANING NOMINAL FILTRATION MICRON	SEDIMENT NOMINAL FILTRATION MICRON	POST CARTRIDGE NOMINAL FILTRATION MICRON	IN/OUT	FLOW RATE l/h	DIMENSIONS mm		
							A	B	C
RA6095126	HYDRA RAINMASTER TRIO RAH CB/EC 3/4" NPT IN	90	25	10	3/4"	4800	390	336	107
RA6095136	HYDRA RAINMASTER TRIO RAH CB/EC 1" NPT IN	90	25	10	1"	5500	390	336	107

For wound thread cartridge specifications see FA at page 215  
 For carbon block cartridge specifications  
 see CB EC CTO at page 261

## VARIANTS AVAILABLE ON MINIMUM QUANTITY:

- HYDRA RAINMASTER TRIO with RLH or RSH prefilter cartridges.

Some items in the list are subject to minimum order quantities and/or to longer delivery term.

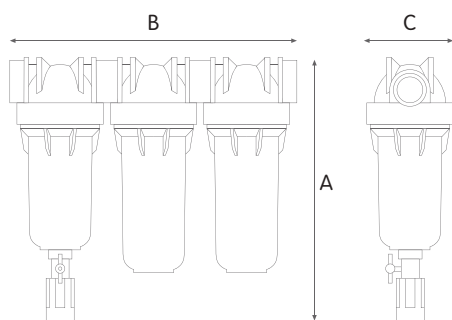

**WORKING CONDITIONS**

Max working pressure:  
 BSP versions \_\_\_\_\_ 8 bar (116 psi)  
 NPT versions \_\_\_\_\_ 8,6 bar (125 psi)  
 Min working pressure \_\_\_\_\_ 1,8 bar (26 psi)  
 Max working temperature \_\_\_\_\_ 45°C (113°F)  
 Min working temperature \_\_\_\_\_ 4°C (39,2°F)



**DRAIN FUNNEL**  
 Back-flow preventing device  
 UNI EN 1717-11/2002

**SPECIFICATIONS**

Non-toxic materials, suitable for drinking water.  
 Head: reinforced polypropylene.  
 Bowl: PET.  
 O-rings: EPDM.  
 Breather-valve: body stainless steel, o-ring EPDM.  
 IN/OUT brass threads: CW 617 N brass.  
 Discharge ball-valve: CW 617 N brass nickel plated.  
 Drain funnel: reinforced polypropylene.

**HYDRA RAINMASTER TRIO RAH with GAC cartridge**

**HOUSINGS WITH BRASS BSP THREADS**

CODE	MODEL	SELF CLEANING NOMINAL FILTRATION MICRON	SEDIMENT NOMINAL FILTRATION MICRON	POST CARTRIDGE NOMINAL FILTRATION MICRON	IN/OUT	FLOW RATE l/h	DIMENSIONS mm		
							A	B	C
RA6095214	HYDRA RAINMASTER TRIO RAH LA 1/2" OT	90	25	-	1/2"	1800	390	336	107
RA6095224	HYDRA RAINMASTER TRIO RAH LA 3/4" OT	90	25	-	3/4"	2500	390	336	107
RA6095234	HYDRA RAINMASTER TRIO RAH LA 1" OT	90	25	-	1"	2800	390	336	107

**HOUSINGS WITH PLASTIC BSP THREADS**

CODE	MODEL	SELF CLEANING NOMINAL FILTRATION MICRON	SEDIMENT NOMINAL FILTRATION MICRON	POST CARTRIDGE NOMINAL FILTRATION MICRON	IN/OUT	FLOW RATE l/h	DIMENSIONS mm		
							A	B	C
RA6095215	HYDRA RAINMASTER TRIO RAH LA 1/2" IN	90	25	-	1/2"	1800	390	336	107
RA6095225	HYDRA RAINMASTER TRIO RAH LA 3/4" IN	90	25	-	3/4"	2500	390	336	107
RA6095235	HYDRA RAINMASTER TRIO RAH LA 1" IN	90	25	-	1"	2800	390	336	107

**HOUSINGS WITH PLASTIC NPT THREADS**

CODE	MODEL	SELF CLEANING NOMINAL FILTRATION MICRON	SEDIMENT NOMINAL FILTRATION MICRON	POST CARTRIDGE NOMINAL FILTRATION MICRON	IN/OUT	FLOW RATE l/h	DIMENSIONS mm		
							A	B	C
RA6095226	HYDRA RAINMASTER TRIO RAH LA 3/4" NPT IN	90	25	-	3/4"	2500	390	336	107
RA6095236	HYDRA RAINMASTER TRIO RAH LA 1" NPT IN	90	25	-	1"	2800	390	336	107

For wound thread cartridge specifications see FA at page 215  
 For GAC cartridge specifications see LA at page 253

**VARIANTS AVAILABLE ON MINIMUM QUANTITY:**

- HYDRA RAINMASTER TRIO with RLH or RSH prefilter cartridges.

Some items in the list are subject to minimum order quantities and/or to longer delivery term.

SELF-CLEANING  
 FILTERS



# KIT AUTO

FOR SELF-CLEANING FILTERS

**KIT AUTO is an assembly product which makes it possible to equip with a fully automatic device all Atlas Filtri self-cleaning items featuring a bottom discharge system.**

The assembly is made of a digital control panel, a solenoid valve, a coil and a cable with power plug. Every Atlas Filtri item with discharge system is provided with components which fit to KIT AUTO and properly complete the item as a fully automatic self-cleaning unit.

KIT AUTO's digital control panel is easy to set up and performs dual programming for operating and opening time on flush operation, with a very wide set of operational timing.

**KIT AUTO is suitable to:**



all filter series HYDRA and HYDRA DS

all filter housings 3P PLUS BX and CX series with discharge system



all filter housings DP, DP DS and DP BIG series with discharge system

all filter housings K DP series with discharge system



all filter series HYDRA RAINMASTER DUO and HYDRA RAINMASTER TRIO



all filter series HYDRA DUO and HYDRA TRIO

KIT AUTO COMPONENTS



electrovalve



coil



digital control panel

## CERTIFICATIONS



Housings are tested and certified under the most stringent procedures worldwide, in compliance with DM 25 (Italy) and with the sanitary certification EAC/Ghostreghistrizia (Russia).



## SYMBOLS LEGEND



For domestic use



For technical and industrial use



# KIT AUTO

## WORKING CONDITIONS

Max working pressure \_\_\_\_\_ 10 bar (145 psi)  
 Min differential pressure \_\_\_\_\_ 0,15 bar (2 psi)  
 Max working temperature \_\_\_\_\_ 45°C (113°F)  
 Min working temperature \_\_\_\_\_ 4°C (39°F)  
 Applicable fluid \_\_\_\_\_ water  
 pH range \_\_\_\_\_ 6,5 - 8,5

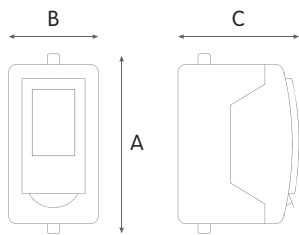

## KIT AUTO

### FOR SELF-CLEANING FILTERS

CODE MODEL

DIGITAL CONTROL PANEL  
 DIMENSIONS mm

RE7120024 KIT AUTO

A	B	C
195	80	100



## TECHNICAL FEATURES

### ELECTROVALVE

#### CONSTRUCTIONS

Body and cover: brass CW 617 N  
 Fitting: stainless steel AISI 304  
 Plunger and core: stainless steel AISI 304  
 Springs: stainless steel AISI 302  
 Diaphragm: EPDM

#### FEATURES

Junction \_\_\_\_\_ 1/2"  
 Conduit \_\_\_\_\_ 12 mm  
 Max discharge flow rate \_\_\_\_\_ 2,5 m³/h

#### SPARE PARTS LIST

1. Coil fixing nut
2. Coil
3. Plunger
4. Armature tube with core
5. Diaphragm
6. Spring

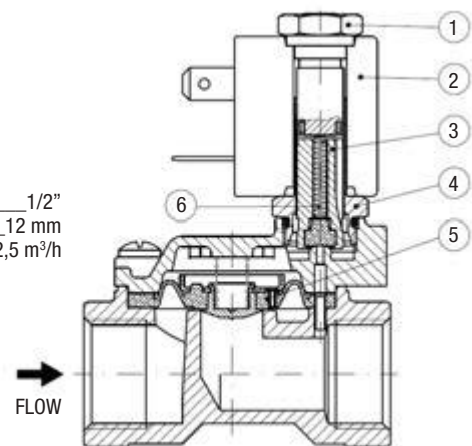

SELF-CLEANING  
 FILTERS

### DIGITAL CONTROL PANEL

#### AUTOMATIC CONTROL

Minimum programmable period for back-wash \_\_\_\_\_ 2 h  
 Maximum programmable period for back-wash \_\_\_\_\_ 99 h  
 Minimum flushing time \_\_\_\_\_ 5 s  
 Maximum flushing time \_\_\_\_\_ 99 s

Power Supply \_\_\_\_\_ AC 50/60 Hz 230 V  
 Plug \_\_\_\_\_ CEE 7/4 (Shuko)  
 Power supply Cable Length \_\_\_\_\_ 1,8 m  
 Coil supply Cable Length \_\_\_\_\_ 1 m

#### MANUAL CONTROL

Manual actuation of the electrovalve \_\_\_\_\_ every 60 s

#### BOX

Protection degree: IP65  
 Dimensions: 150x100x80 mm

### COIL

Power Supply \_\_\_\_\_ AC 50/60 Hz 24V  
 Insulation class \_\_\_\_\_ F  
 Protection class with connector fixed \_\_\_\_\_ IP65





# POU

housings and systems

Range of housings and systems, designed for the installation at Point-Of-Use, under-sink or counter-top, for drinking water purposes

# DEPURAL®

## MOBILE FILTER HOUSINGS

DEPURAL® is a range of patented mobile filter housings especially designed for counter-top use, complete with standing base, installation kit and universal adaptor for easy connection to the tap.

DEPURAL® housings are available as single housings and as Duplex housings providing dual filtration, all models fit to standard 10" cartridges available from the wide range of Atlas Filtri cartridges SX type.

DEPURAL® housings are manufactured with the finest and most advanced materials under constant focus on innovative processing technologies and ceaseless modernization to ensure the absolute quality of our products.

A range of accessories is available on demand: spanner, wall brackets, installation kit with diverter valve.



**SX** cartridges  
with standard flat seals.



DEPURAL® mobile filters easy to be connected to the kitchen tap or to any water distributor.

## CERTIFICATION

**EAC**

Housings are tested and certified under the most stringent procedures worldwide, in compliance with the sanitary certification EAC/Ghostreghistrizia (Russia).

## ACCESSORIES INCLUDED



base for Depural®



wall bracket for Depural® (Depural® BS 10)



kit for Depural®

## ACCESSORIES ON DEMAND



-NV- spanner CODE RB7403005

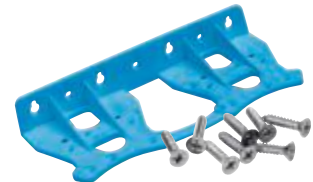

-D- wall bracket for Depural® duplex CODE RB7400009



kit for Depural® with diverter valve CODE LB7202002



-LUBRIKIT- single-dose lubricant for housing o-ring  
CODE RE9020650

## SYMBOLS LEGEND



For domestic use



# DEPURAL®

## WORKING CONDITIONS

Max working pressure \_\_\_\_\_ 3 bar (43 psi)  
 Max working temperature \_\_\_\_\_ 45°C (113°F)  
 Min working temperature \_\_\_\_\_ 4°C (39,2°F)

## SPECIFICATIONS

Non-toxic materials, suitable for drinking water.  
 Head: polypropylene.  
 Bowl: polystyrene.  
 O-rings: EPDM.  
 Spout: ABS.  
 Hose: PVC.



### DEPURAL® B10

#### CLEAR BOWL

CODE: RA2030615  
 SUITABLE CARTRIDGES: 10"

### DEPURAL® BS10

#### CLEAR BOWL

CODE: RA2030637  
 SUITABLE CARTRIDGES: 10"

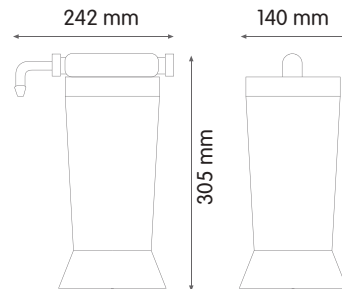

### DEPURAL® B10 DUPLEX

#### CLEAR BOWL

CODE: RA2010615  
 SUITABLE CARTRIDGES: 10"

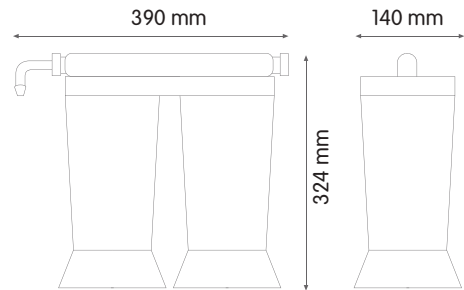

DRINKING  
WATER UNITS

## VARIANTS AVAILABLE ON MINIMUM QUANTITY:

- Depural® and Depural® duplex with blue bowl



# DEPURAL® TOP

## MOBILE FILTER HOUSINGS

**DEPURAL® TOP is a range of mobile filter housings especially designed for counter-top use**, complete installation kit and diverter valve for easy connection to the tap. The diverter valve make it possible to divert the tap water to the filter or to standard service unfiltered, preserving the filter cartridge and prolonging its life-time.

DEPURAL® TOP housings are available in 3 main versions:

- **DEPURAL® TOP single housings**, with clear (TS) white (BW) or chromed (CH) bowls.
- **DEPURAL® TOP DUO double housings**, with clear (TS) white (BW) or chromed (CH) bowls.
- **DEPURAL® TOP TRIO triple housings**, with clear (TS) white (BW) or chromed (CH) bowls.

DEPURAL® TOP fit to 10" cartridges with both standard SX flat seals (DOE) and BX quick-fit double o-ring end-cap, all available from the wide range of Atlas Filtri cartridges SX and BX type.

DEPURAL® TOP housings are manufactured with the finest and most advanced materials under constant focus on innovative processing technologies and ceaseless modernization to ensure the absolute quality of our products.



**SX** cartridges with standard flat seals.



**BX** cartridges with 45 mm double o-ring collar. Quick-fit connection for a perfect tightening.



## CERTIFICATION

**EAC**

Housings are tested and certified under the most stringent procedures worldwide, **in compliance with the sanitary certification EAC/Ghostreghistrizia (Russia).**

## ACCESSORIES INCLUDED



kit Depural® TOP DVB



kit Depural® TOP ECO



spanner for Depural® TOP

## ACCESSORY ON DEMAND



-LUBRIKIT- single-dose lubricant for housing o-ring  
CODE RE9020650

## SYMBOLS LEGEND



For domestic use



# DEPURAL® TOP

## WORKING CONDITIONS

Max working pressure \_\_\_\_\_ 3 bar (43 psi)  
 Max working temperature \_\_\_\_\_ 45°C (113°F)  
 Min working temperature \_\_\_\_\_ 4°C (39,2°F)

## SPECIFICATIONS

Non-toxic materials, suitable for drinking water.  
 Head: polypropylene.  
 White bowl: SAN.  
 O-rings: EPDM.



### DEPURAL® TOP ECO BW

#### WHITE HOUSING

CODE: RA2511615  
 SUITABLE CARTRIDGES: 10"

### DEPURAL® TOP DVB BW

#### WHITE HOUSING

CODE: RA2510615  
 SUITABLE CARTRIDGE: 10"

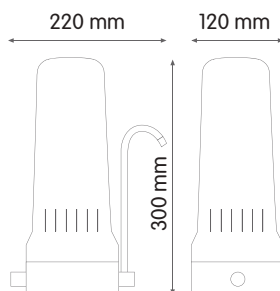

### DEPURAL® TOP DUO ECO BW

#### WHITE HOUSING

CODE: RA2521615  
 SUITABLE CARTRIDGES: 10"

### DEPURAL® TOP DUO DVB BW

#### WHITE HOUSING

CODE: RA2520618  
 SUITABLE CARTRIDGES: 10"

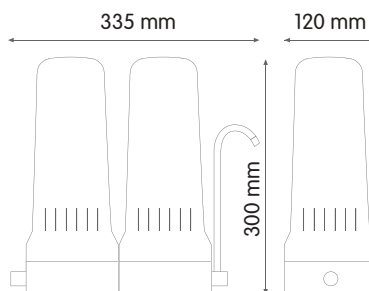

### DEPURAL® TOP TRIO ECO BW

#### WHITE HOUSING

CODE: RA2531615  
 SUITABLE CARTRIDGES: 10"

### DEPURAL® TOP TRIO DVB BW

#### WHITE HOUSING

CODE: RA2530615  
 SUITABLE CARTRIDGES: 10"

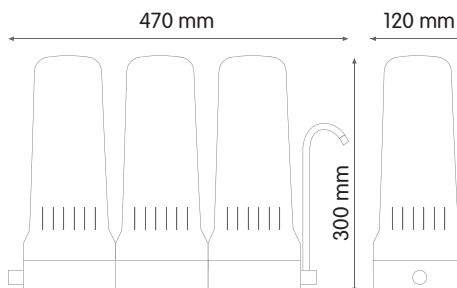

DRINKING WATER UNITS

**WORKING CONDITIONS**

Max working pressure \_\_\_\_\_ 3 bar (43 psi)  
 Max working temperature \_\_\_\_\_ 45°C (113°F)  
 Min working temperature \_\_\_\_\_ 4°C (39,2°F)

**SPECIFICATIONS**

Non-toxic materials, suitable for drinking water.  
 Head: polypropylene.  
 Transparent bowl: SAN.  
 O-rings: EPDM.



**DEPURAL® TOP ECO TS**

**CLEAR HOUSING**

CODE: RA2511616  
 SUITABLE CARTRIDGES: 10"

**DEPURAL® TOP DVB TS**

**CLEAR HOUSING**

CODE: RA2510616  
 SUITABLE CARTRIDGES: 10"

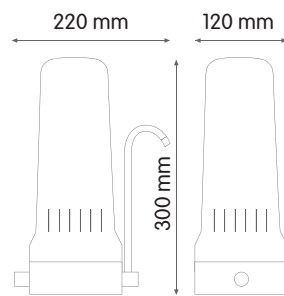

**DEPURAL® TOP DUO ECO TS**

**CLEAR HOUSING**

CODE: RA2521616  
 SUITABLE CARTRIDGES: 10"

**DEPURAL® TOP DUO DVB TS**

**CLEAR HOUSING**

CODE: RA2520616  
 SUITABLE CARTRIDGES: 10"

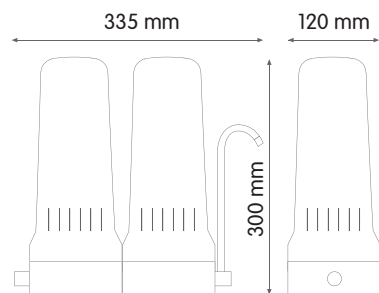

**DEPURAL® TOP TRIO ECO TS**

**CLEAR HOUSING**

CODE: RA2531616  
 SUITABLE CARTRIDGES: 10"

**DEPURAL® TOP TRIO DVB TS**

**CLEAR HOUSING**

CODE: RA2530616  
 SUITABLE CARTRIDGES: 10"

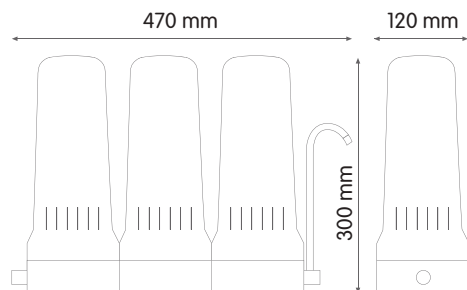

**WORKING CONDITIONS**

Max working pressure \_\_\_\_\_ 3 bar (43 psi)  
 Max working temperature \_\_\_\_\_ 45°C (113°F)  
 Min working temperature \_\_\_\_\_ 4°C (39,2°F)

**SPECIFICATIONS**

Non-toxic materials, suitable for drinking water.  
 Head: polypropylene.  
 Chrome plated bowl: ABS.  
 O-rings: EPDM.



**DEPURAL® TOP ECO CH**

**CHROME HOUSING**

CODE: RA2511617  
 SUITABLE CARTRIDGES: 10"

**DEPURAL® TOP DVB CH**

**CHROME HOUSING**

CODE: RA2510617  
 SUITABLE CARTRIDGES: 10"

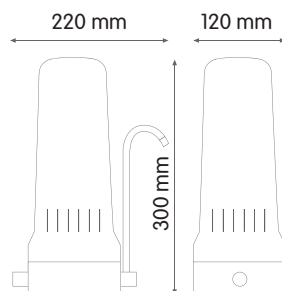

**DEPURAL® TOP DUO ECO CH**

**CHROME HOUSING**

CODE: RA2521617  
 SUITABLE CARTRIDGES: 10"

**DEPURAL® TOP DUO DVB CH**

**CHROME HOUSING**

CODE: RA2520619  
 SUITABLE CARTRIDGES: 10"

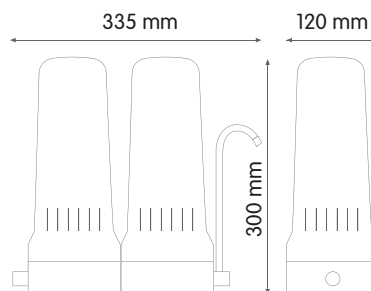

**DEPURAL® TOP TRIO ECO CH**

**CHROME HOUSING**

CODE: RA2531617  
 SUITABLE CARTRIDGES: 10"

**DEPURAL® TOP TRIO DVB CH**

**CHROME HOUSING**

CODE: RA2530617  
 SUITABLE CARTRIDGES: 10"

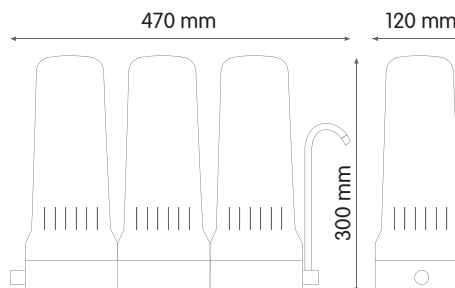

DRINKING  
 WATER UNITS

# DEPURAL® DP / DP CASE

## MOBILE FILTER HOUSINGS

A range of mobile filter housings made up with patented and registered **DP MONO, DP DUO and DP TRIO housings**, DEPURAL DP are especially designed for counter-top use, complete with standing base, installation kit and universal adaptor for easy connection to the tap.

DEPURAL DP housings are available in 3 main versions:

- **DEPURAL® DP MONO** single clear (TS) or white (BW) housings.
- **DEPURAL® DP DUO** double clear (TS) or white (BW) housings.
- **DEPURAL® DP TRIO** triple clear (TS) or white (BW) housings.

**Exclusive DEPURAL® DP CASE with DP TRIO housings in plastic case is a portable version of mobile filters**, complete with universal tap adaptor and connection kit.

A variety of DEPURAL® DP housings fit to 5", 7", 10" cartridges with both standard SX flat seals (DOE) and BX quick-fit double o-ring end-cap, all available from the wide range of Atlas Filtri cartridges SX and BX type. All housings are provided with Filter-Fit, special centering device for SX cartridges.

DEPURAL® DP housings are manufactured with the finest and most advanced materials under constant focus on innovative processing technologies and ceaseless modernization to ensure the absolute quality of our products.

A range of accessories is available on demand: spanner, wall brackets.



**SX** cartridges with standard flat seals.



**BX** cartridges with 45 mm double o-ring collar. Quick-fit connection for a perfect tightening.

## CERTIFICATIONS



Housings are tested and certified under the most stringent procedures worldwide, in compliance with **DM 25 (Italy)**, with the sanitary certification **ACS (France)** and **EAC/Ghostreghistrizia (Russia)**.

## ACCESSORIES INCLUDED

\* white colour provided with housings BW (white)



-X- spanner\*



DP Base\*



-S- wall bracket\*



-DUO- wall bracket\*



-TRIO- wall bracket\*



Filterfit - cartridge centering device

## ACCESSORY ON DEMAND



-LUBRIKIT- single-dose lubricant for housing o-ring  
CODE RE9020650

## SYMBOLS LEGEND



For domestic use



Filter housings made in PET, a highly recyclable plastic, are manufactured with a proprietary procedure saving up to 60% of energy in injection molding compared with standard plastics. That is one of Atlas Filtri commitments to comply with Kyoto Treaty for the reduction of green house gas (CO<sub>2</sub>) emissions in the atmosphere.





# DEPURAL® DP

## WORKING CONDITIONS

Max working pressure \_\_\_\_\_ 3 bar (43 psi)  
 Max working temperature \_\_\_\_\_ 45°C (113°F)  
 Min working temperature \_\_\_\_\_ 4°C (39,2°F)

## HOUSINGS SPECIFICATIONS

Non-toxic materials, suitable for drinking water.  
 Head: reinforced polypropylene.  
 Bowl: PET.  
 O-rings: EPDM.  
 Breather-valve: body stainless steel, o-ring EPDM.



kit for Depural® DP



kit for Depural® DP CASE ST



kit for Depural® DP CASE HS



## DEPURAL® DP MONO TS

### CLEAR BOWL

CODE: RA2610101  
 SUITABLE CARTRIDGES: 10"

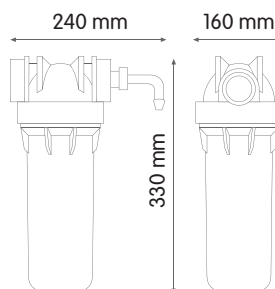

## DEPURAL® DP DUO TS

### CLEAR BOWL

CODE: RA2610201  
 SUITABLE CARTRIDGES: 10"

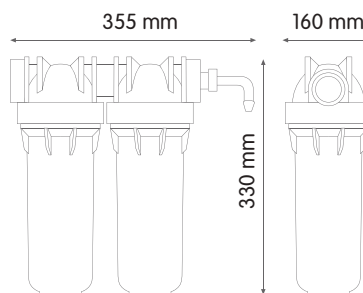

## DEPURAL® DP TRIO TS

### CLEAR BOWL

CODE: RA2610301  
 SUITABLE CARTRIDGES: 10"

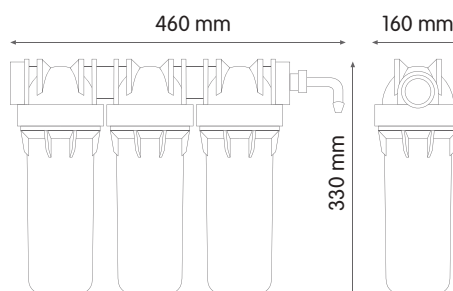

DRINKING  
WATER UNITS



**WORKING CONDITIONS**

Max working pressure \_\_\_\_\_ 3 bar (43 psi)  
 Max working temperature \_\_\_\_\_ 45°C (113°F)  
 Min working temperature \_\_\_\_\_ 4°C (39,2°F)

**HOUSINGS SPECIFICATIONS**

Non-toxic materials, suitable for drinking water.  
 Head: reinforced polypropylene.  
 Bowl: PET.  
 O-rings: EPDM.  
 Breather-valve: body stainless steel, o-ring EPDM.



**DEPURAL® DP MONO BW**

**WHITE BOWL**

CODE: RA2610102  
 SUITABLE CARTRIDGES: 10"

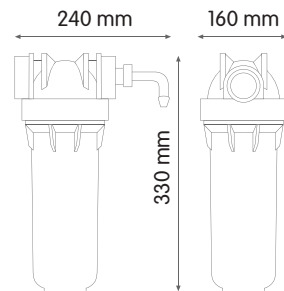

**DEPURAL® DP DUO BW**

**WHITE BOWL**

CODE: RA2610202  
 SUITABLE CARTRIDGES: 10"

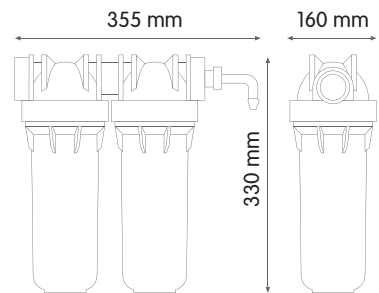

**DEPURAL® DP TRIO BW**

**WHITE BOWL**

CODE: RA2610302  
 SUITABLE CARTRIDGES: 10"

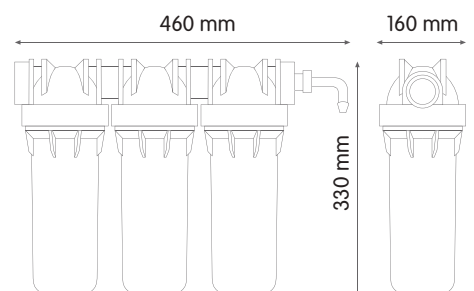



# DEPURAL® DP CASE

## WORKING CONDITIONS

Max working pressure \_\_\_\_\_ 3 bar (43 psi)  
 Max working temperature \_\_\_\_\_ 45°C (113°F)  
 Min working temperature \_\_\_\_\_ 4°C (39,2°F)

## HOUSINGS SPECIFICATIONS

Non-toxic materials, suitable for drinking water.  
 Head: reinforced polypropylene.  
 Bowl: PET.  
 O-rings: EPDM.  
 Breather-valve: body stainless steel, o-ring EPDM.



## DEPURAL® DP CASE ST BW

### UNIVERSAL TAP

CODE: RA6081402  
 SUITABLE CARTRIDGES: 10"

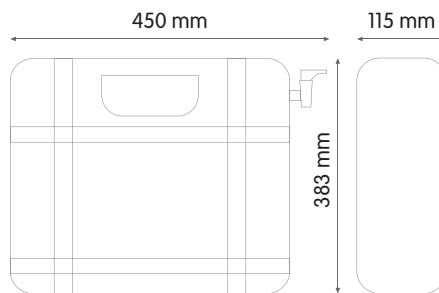

## DEPURAL® DP CASE HS BW

### GARDEN HOSE

CODE: RA6081401  
 SUITABLE CARTRIDGES: 10"

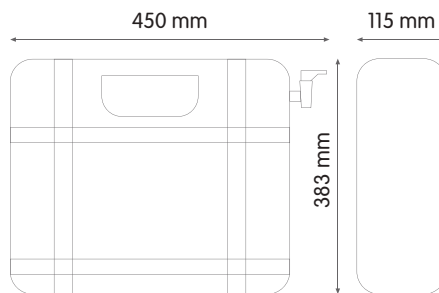

DRINKING  
WATER UNITS

# BRAVO DP / DP CASE

## UNDER-SINK FILTER HOUSINGS

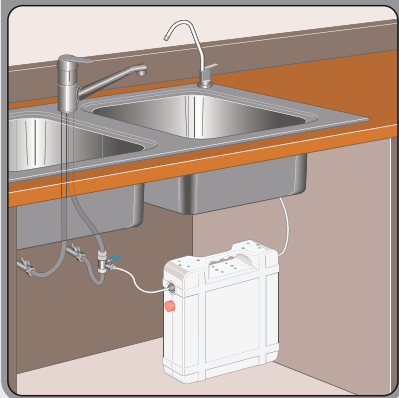
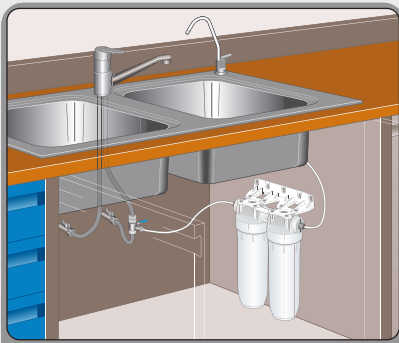

A range of filter housings made up with patented and registered DP MONO, DP DUO and DP TRIO housings, BRAVO DP are especially designed for the installation under the kitchen sink, complete with standard quick-fit connections and dedicated tap, available as BRAVO DP MONO single housings, BRAVO DP DUO double housings and BRAVO DP TRIO triple housings.

Exclusive **BRAVO DP CASE with DP TRIO housings** in plastic case is a portable version of under-sink filters, complete with connection kit and dedicated tap.

All BRAVO DP housings fit to 10" cartridges with both standard SX flat seals (DOE) and BX quick-fit double o-ring end-cap, available from the wide range of Atlas Filtri cartridges SX and BX type. All housings are provided with Filter-Fit, special centering device for SX cartridges.

BRAVO DP housings are manufactured with the finest and most advanced materials under constant focus on innovative processing technologies and ceaseless modernization to ensure the absolute quality of our products.

Accessory spanner and wall brackets are provided with the package. A standing base for housings is available on demand. Sanding bases for housings and UV lamps for water sterilization are available as accessory on demand.



**SX** cartridges with standard flat seals.



**BX** cartridges with 45 mm double o-ring collar. Quick-fit connection for a perfect tightening.

## CERTIFICATIONS



Housings are tested and certified under the most stringent procedures worldwide, in compliance with DM 25 (Italy), with the sanitary certification ACS (France) and EAC/Ghostreghistrizia (Russia).

## ACCESSORIES INCLUDED



-S- wall bracket



-DUO- wall bracket



-TRIO- wall bracket



-X- spanner



Filterfit - cartridge centering device



kit for Bravo DP

## SYMBOLS LEGEND



For domestic use



Filter housings made in PET, a highly recyclable plastic, are manufactured with a proprietary procedure saving up to 60% of energy in injection molding compared with standard plastics. That is one of Atlas Filtri commitments to comply with Kyoto Treaty for the reduction of green house gas (CO<sub>2</sub>) emissions in the atmosphere.



# BRAVO DP / DP CASE

## ACCESSORIES ON DEMAND



DEPURAL® DP Base CODE LB7402015



-LUBRIKIT- single-dose lubricant for housing o-ring

CODE RE9020650



KIT UV 300 Bravo DP CODE EA3510011

KIT UV 600 Bravo DP CODE EA3510012

for UV LAMP specifications see page 321

## WORKING CONDITIONS

Max working pressure \_\_\_\_\_ 8 bar (116 psi)  
 Max working temperature \_\_\_\_\_ 45°C (113°F)  
 Min working temperature \_\_\_\_\_ 4°C (39,2°F)

## HOUSINGS SPECIFICATIONS

Non-toxic materials, suitable for drinking water.  
 Head: reinforced polypropylene.  
 Bowl: PET. O-rings: EPDM.  
 Breather-valve: body stainless steel, o-ring EPDM.



## BRAVO DP MONO

### WITH STANDARD QUICK-FIT CONNECTIONS

CODE: RA6080010

SUITABLE CARTRIDGES: 10"

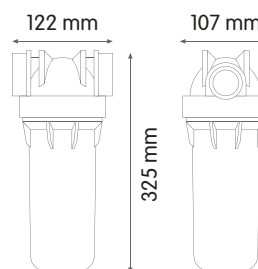

## BRAVO DP DUO

### WITH STANDARD QUICK-FIT CONNECTIONS

CODE: RA6080003

SUITABLE CARTRIDGES: 10"

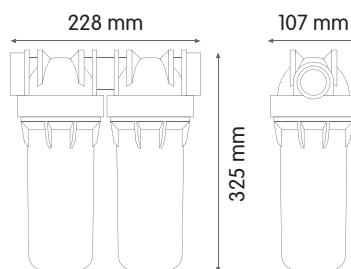

## BRAVO DP TRIO

### WITH STANDARD QUICK-FIT CONNECTIONS

CODE: RA6080320

SUITABLE CARTRIDGES: 10"

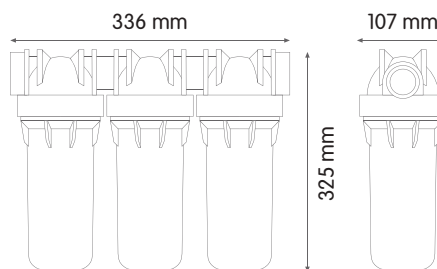

## BRAVO DP TRIO CASE

### WITH STANDARD QUICK-FIT CONNECTIONS

CODE: RA6081300

SUITABLE CARTRIDGE: 10"

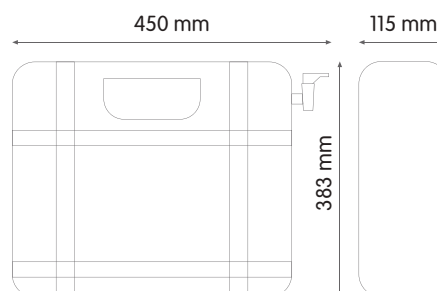

DRINKING WATER UNITS

# IN LINE

## FILTERS

A range of filters designed for the installation under the kitchen sink, made up with the exclusive IN-LINE filter housing with double o-ring, with a range of dedicated and proprietary filter cartridges.

IN-LINE filters come complete with standard quick-fit connections and dedicated tap.

The opening spanner is included in the package .

IN LINE housings are manufactured with the finest and most advanced materials under constant focus on innovative processing technologies and ceaseless modernization to ensure the absolute quality of our products.

### Exclusive features

IN-LINE filters fit only to the proprietary range of dedicated cartridges In-line, with exclusive design of end-caps and sealing:

#### CPP in-line melt-blown PP cartridge

sediment filter



CODE		FILTRATION
RE5716408	CPP LINE - 5 mcr	5 mcr
RE5716411	CPP LINE - 25 mcr	25 mcr

#### HA In-line polyphosphate crystals cartridge

anti-scale conditioning



CODE	
RA5191125	HA LINE - TS

#### P In-line

fillable empty container



CODE	
RB5171125	P LINE - TS

#### LA In-line granular activated carbon (GAC) cartridge

chlorine-taste-odour (CTO) reduction



CODE	
RA5181125	LA LINE - TS

#### CA-SE In-line carbon-block cartridge

sediment and chlorine-taste-odour (CTO) reduction



CODE		FILTRATION
RE5371408	CA-SE LINE - 5 mcr	5 mcr



## ACCESSORIES INCLUDED



-IL- spanner

available for IN LINE HOUSING CODE RB7403014



clips 60 mm with screws

available for IN LINE HOUSING CODE RB6332000



kit IN-LINE FILTER

available for IN LINE HOUSING CODE LB7202135

## ACCESSORY ON DEMAND



-LUBRIKIT- single-dose lubricant for housing o-ring  
CODE RE9020650

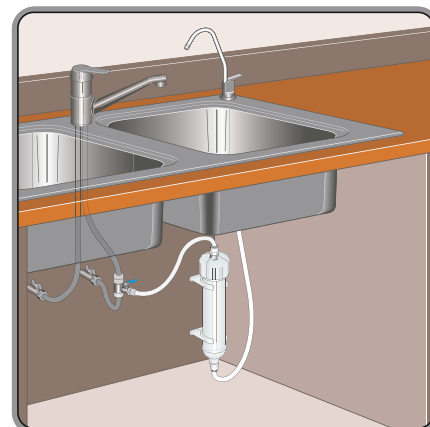

## CERTIFICATION



Housings are tested and certified under the most stringent procedures worldwide, in compliance with the sanitary certification EAC/Ghostreghistrasia (Russia).

## SYMBOLS LEGEND



For domestic use



# IN LINE

## WORKING CONDITIONS

Max working pressure \_\_\_\_\_ 8 bar (116 psi)  
 Max working temperature \_\_\_\_\_ 45°C (113°F)  
 Min working temperature \_\_\_\_\_ 4°C (39,2°F)

## HOUSING SPECIFICATIONS

Non-toxic materials, suitable for drinking water.  
 Head and bowl: reinforced polypropylene.  
 O-rings: EPDM.



## IN LINE housing 1/4" BW

CODE:	RB6500010
IN/OUT:	1/4"



## IN-LINE filter BW

### WITH STANDARD QUICK-FIT CONNECTIONS

CODE:	RA6500005
-------	-----------



# OASIS DP RO

## REVERSE OSMOSIS UNITS WITH MADE IN ITALY COMPONENTS

OASIS DP is a range of RO units made up with patented and registered DP TRIO filter housings and with RO VESSEL, exclusive reverse osmosis membrane housing with double o-ring.

OASIS DP are especially designed for the installation under the kitchen sink, complete with installation kit. All OASIS DP are based on a standard 6 stages unit, made up of: 3 pre-filtration stages, RO membrane stage, G.A.C. activated carbon post-filter stage, re-mineralizer post-filter stage. The units are available in 2 main versions:

- **OASIS DP with metal wall bracket**, available in 4 models:  
OASIS DP STD - standard 6 stages unit.  
OASIS DP PUMP - standard 6 stages unit with booster pump.  
OASIS DP UV - standard 6 stages unit with UV lamp.  
OASIS DP PUMP-UV - standard 6 stages unit with booster pump and UV lamp.
- **OASIS DP-F with metal frame**, available in 2 models:  
OASIS DP-F PUMP - standard 6 stages unit with booster pump.  
OASIS DP-F PUMP-UV - standard 6 stages unit with booster pump and UV lamp.

In case of inlet pressure below 3 bar (45.5 psi) use only models with pump (PUMP, PUMP-UV).

## Made in Italy components

### Exclusive Atlas Filtri Products

#### DP TRIO filter housing

Triple housing made with reinforced PP head, reinforced PP white opaque bowls and clear bowl made in PET, a highly recyclable plastic, manufactured with energy-saving proprietary technology.

#### REGISTERED MODEL - PATENTED



A range of housings is certified by IAPMO RT to NSF/ANSI 42, 61, 372 - lead free, CSA B483.1. In compliance with Drinking Water Treatment Units regulations, USA and Canada.



#### RO VESSEL membrane housing with double o-ring

Exclusive design with double o-ring to ensure perfect tightening.



#### ORIGINAL SPANNERS

Spanner for RO VESSEL  
Spanner for DP TRIO filter housing



**FILTERFIT**  
Cartridge centering device



**O-RINGS**  
for DP TRIO filter housing



**LUBRIKIT**  
Single-dose lubricant for housing o-ring

## High efficiency pre-filter cartridges

### SEDIMENT



**PP MELT BLOWN**  
FILTER 5 micron

PP melt-blown filter: filtration of sand, scales, lime, rust, fine particles. Life-span: 3-6 months. Max temperature: 45°C (113°F).



CPP 10 SX 5 mcr cartridges are certified by IAPMO RT to NSF/ANSI 42 - Material Safety Only, 61, 372 - lead free, CSA B483.1 - Material Safety Only. In compliance with Drinking Water Treatment Units regulations, USA and CANADA.

### CTO

CHLORINE  
TASTE ODOR



**CARBON G.A.C.**

Container with granular activated carbon: reduction of chlorine (bad tastes, odors) and chloride pollutants (pesticides, solvents). Life-span: 3-6 months. Max temperature: 45°C (113°F).

### CTO

CHLORINE  
TASTE ODOR



**CARBON BLOCK**  
FILTER 5 micron

Activated carbon block: filtration of fine particles, rust, lime, sand scales; reduction of chlorine (bad tastes, odors) and chloride pollutants (pesticides, solvents). Life-span: 3-6 months. Max temperature: 45°C (113°F).

## FILTER CARTRIDGES REPLACEMENT KIT



Ask for original replacement filter cartridges and grant your OASIS DP RO unit the best performances.

STAGE 1: Sediment filter 5 micron  
STAGE 2: CTO Granular Activated Carbon (G.A.C.)  
STAGE 3: CTO Carbon Block filter 5 micron

### UNITS MAJOR FEATURES

- 50 GPD - 1812 RO membrane
- Quick-fit connections
- Shut-off valve (STD and UV models)
- Solenoid valve (PUMP and PUMP-UV models)
- Pressure gauge (F models with frame)
- Min pressure switch
- Max pressure switch
- AIC activated carbon post-filter
- AIM re-mineralizer post-filter
- Installation kit with dedicated tap
- 12 liters (3.2 gallons) metal storage tank
- AC plug 2 pins C type - CEE 7/16 (Europlug)

### COMPONENT VARIANTS AVAILABLE ON DEMAND

- 100 GPD - 1812 RO membrane
- Filmtec 50/100 GPD - 1812 RO membrane
- Lead free dedicated faucet
- 15,14 liters (4 gallons) plastic tank
- AC plugs of different types

### MADE IN ITALY COMPONENTS CERTIFICATIONS



Housings are tested and certified under the most stringent procedures worldwide, in compliance with DM 25 (Italy), with the sanitary certification ACS (France), EAC/Ghostreghistrazia (Russia) and WaterMark (Australia).

### SYMBOLS LEGEND



For domestic use



Filter housings made in PET, a highly recyclable plastic, are manufactured with a proprietary procedure saving up to 60% of energy in injection molding compared with standard plastics. That is one of Atlas Filtri commitments to comply with Kyoto Treaty for the reduction of green house gas (CO<sub>2</sub>) emissions in the atmosphere.



# OASIS DP

## WORKING CONDITIONS

Max inlet pressure STD model	8 bar (116 psi)	Max working temperature	45°C (113°F)
Min inlet pressure STD model	3 bar (45.5 psi)	Min working temperature	4°C (39.2°F)
Max inlet pressure PUMP model	3 bar (45.5 psi)	Max TDS	1000 ppm
Min inlet pressure PUMP model	0,5 bar (7.2 psi)	Membrane capacity	50 GPD (190 l/day)



## OASIS DP STD

RO UNIT WITH METAL WALL BRACKET	
CODE	RE6075310
MODEL	OASIS DP TRIO 50 - STD
RO membrane	50 GPD - 1812

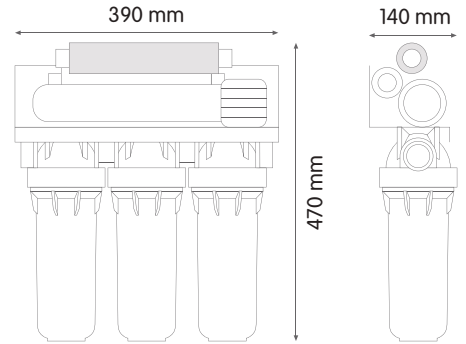

## OASIS DP PUMP

RO UNIT WITH METAL WALL BRACKET	
CODE	RE6075320
MODEL	OASIS DP TRIO 50 - PUMP
RO membrane	50 GPD - 1812

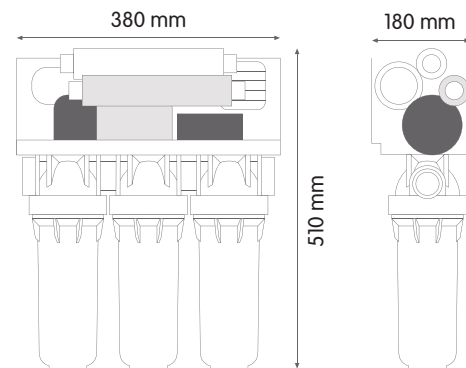

## DIAPHRAGM BOOSTER PUMP

SUPPLY POWER	220/110 V - 50/60 Hz	CE
VOLTAGE	24 V	
AMPERAGE	0,75 A	
POWER	16 W	
FLOW AT 5,5 bar (80 psi)	0,75 l/min (0.19 GPM)	
OPEN FLOW	1 l/min (0.26 GPM)	
MAX OUTPUT PRESSURE	8 bar (116 psi)	



## COMPLETE WITH METAL STORAGE TANK

- 12 liters (3.2 gallons)

**WORKING CONDITIONS**

Max inlet pressure UV model	8 bar (116 psi)	Max working temperature	45°C (113°F)
Min inlet pressure UV model	3 bar (45.5 psi)	Min working temperature	4°C (39.2°F)
Max inlet pressure PUMP-UV model	3 bar (45.5 psi)	Max TDS	1000 ppm
Min inlet pressure PUMP-UV model	0,5 bar (7.2 psi)	Membrane capacity	50 GPD (190 l/day)



**OASIS DP UV**

RO UNIT WITH METAL WALL BRACKET	
CODE	RE6075330
MODEL	OASIS DP TRIO 50 - UV
RO membrane	50 GPD - 1812

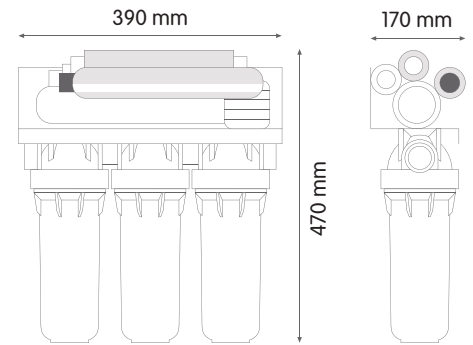

**UV LAMP**

UV-C DOSE	210 J/m <sup>2</sup>	CE
SUPPLY POWER	220/110 V - 50/60 Hz	
VOLTAGE	24 V	
AMPERAGE	0,16 A	
ELECTRICAL ABSORPTION	6 W/h	
LAMP SERVICE LIFE	8000 hours	



**OASIS DP PUMP-UV**

RO UNIT WITH METAL WALL BRACKET	
CODE	RE6075340
MODEL	OASIS DP TRIO 50 - PUMP-UV
RO membrane	50 GPD - 1812

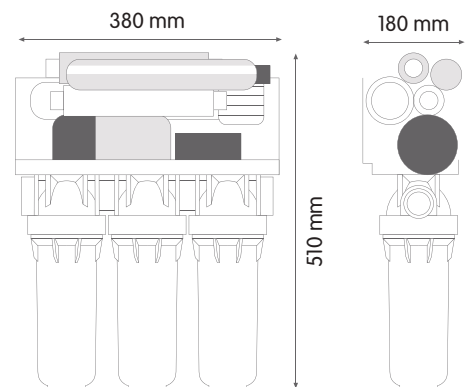

**DIAPHRAGM BOOSTER PUMP**

SUPPLY POWER	220/110 V - 50/60 Hz	CE
VOLTAGE	24 V	
AMPERAGE	0,75 A	
POWER	16 W	
FLOW AT 5,5 bar (80 psi)	0,75 l/min (0.19 GPM)	
OPEN FLOW	1 l/min (0.26 GPM)	
MAX OUTPUT PRESSURE	8 bar (116 psi)	

**UV LAMP**

UV-C DOSE	210 J/m <sup>2</sup>	CE
SUPPLY POWER	220/110 V - 50/60 Hz	
VOLTAGE	24 V	
AMPERAGE	0,16 A	
ELECTRICAL ABSORPTION	6 W/h	
LAMP SERVICE LIFE	8000 hours	



**COMPLETE WITH METAL STORAGE TANK**

- 12 liters (3.2 gallons)



# OASIS DP-F

## WORKING CONDITIONS

Max inlet pressure	3 bar (45.5 psi)	Max working temperature	45°C (113°F)
Min inlet pressure	0.5 bar (7.2 psi)	Min working temperature	4°C (39.2°F)
		Max TDS	1000 ppm
		Membrane capacity	50 GPD (190 l/day)



### COMPLETE WITH METAL STORAGE TANK

- 12 liters (3.2 gallons)

## OASIS DP-F PUMP

### RO UNIT WITH METAL FRAME

CODE	RE6075350
MODEL	OASIS DP-F TRIO 50 PUMP
RO membrane	50 GPD - 1812

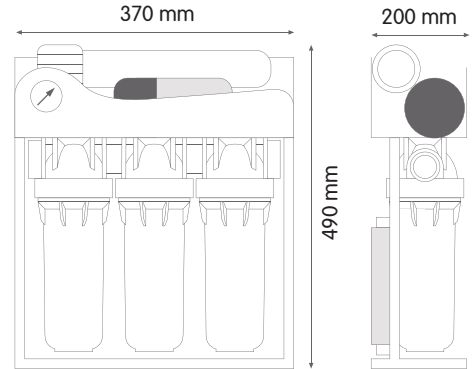

### DIAPHRAGM BOOSTER PUMP

SUPPLY POWER	220/110 V - 50/60 Hz	
VOLTAGE	24 V	
AMPERAGE	0,75 A	
POWER	16 W	
FLOW AT 5,5 bar (80 psi)	0,75 l/min (0.19 GPM)	
OPEN FLOW	1 l/min (0.26 GPM)	
MAX OUTPUT PRESSURE	8 bar (116 psi)	

## OASIS DP-F PUMP-UV

### RO UNIT WITH METAL FRAME

CODE	RE6075360
MODEL	OASIS DP-F TRIO 50 PUMP-UV
RO membrane	50 GPD - 1812

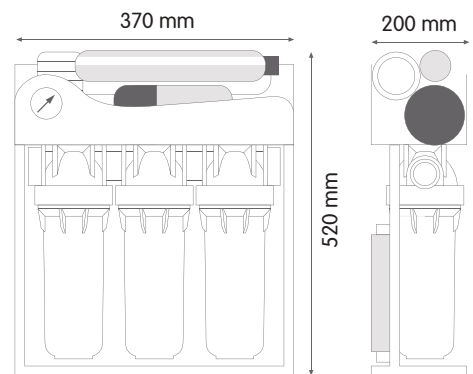

### DIAPHRAGM BOOSTER PUMP

SUPPLY POWER	220/110 V - 50/60 Hz	
VOLTAGE	24 V	
AMPERAGE	0,75 A	
POWER	16 W	
FLOW AT 5,5 bar (80 psi)	0,75 l/min (0.19 GPM)	
OPEN FLOW	1 l/min (0.26 GPM)	
MAX OUTPUT PRESSURE	8 bar (116 psi)	

### UV LAMP

UV-C DOSE	210 J/m <sup>2</sup>	
SUPPLY POWER	220/110 V - 50/60 Hz	
VOLTAGE	24 V	
AMPERAGE	0,16 A	
ELECTRICAL ABSORPTION	6 W/h	
LAMP SERVICE LIFE	8000 hours	

DRINKING WATER UNITS



OASIS DP SANIC is a range of RO units made up with patented and registered DP TRIO SANIC filter housings and with RO VESSEL SANIC, exclusive reverse osmosis membrane housing with double o-ring, featuring Antimicrobial Product Protection provided by silver-based technology which prevents the growth of stain and odor causing bacteria, keeping the unit cleaner for longer.

OASIS DP SANIC are especially designed for the installation under the kitchen sink, complete with installation kit. All OASIS DP SANIC are based on a standard 6 stages unit, made up of: 3 pre-filtration stages, RO membrane stage, G.A.C. activated carbon post-filter stage, re-mineralizer post-filter stage. The units are available in 2 main versions:

- **OASIS DP SANIC with metal wall bracket**, available in 4 models:  
OASIS DP SANIC STD - standard 6 stages unit.  
OASIS DP SANIC PUMP - standard 6 stages unit with booster pump.  
OASIS DP SANIC UV - standard 6 stages unit with UV lamp.  
OASIS DP SANIC PUMP-UV - standard 6 stages unit with booster pump and UV lamp.
- **OASIS DP-F SANIC with metal frame**, available in 2 models:  
OASIS DP-F SANIC PUMP - standard 6 stages unit with booster pump.  
OASIS DP-F SANIC PUMP-UV - standard 6 stages unit with booster pump and UV lamp.

In case of inlet pressure below 3 bar (45.5 psi) use only models with pump (PUMP, PUMP-UV).

## Made in Italy components Exclusive Atlas Filtri Products

### DP TRIO SANIC filter housing

DP TRIO SANIC filter housing made with reinforced PP head, reinforced PP opaque bowl and clear bowls made in PET, all components featuring Antimicrobial Product Protection provided by silver-based technology which prevents the growth of stain and odor causing bacteria, keeping the filter housing cleaner for longer.

REGISTERED MODEL - PATENTED



Systems tested and certified by IAPMO RT against NSF/ANSI 42 for bacteriostasis effect. Components tested and certified by IAPMO RT against NSF/ANSI Standards 42 and 61 for material and structural integrity requirements only. In compliance with Drinking Water Treatment Units regulations, USA and Canada.



### RO VESSEL SANIC membrane housing with Antimicrobial Product Protection

Exclusive design with double o-ring to ensure perfect tightening.



### ORIGINAL SPANNERS

Spanner for RO VESSEL SANIC  
Spanner for DP TRIO SANIC filter housing



**FILTERFIT**  
Cartridge centering device



**O-RINGS**  
for DP TRIO filter housing



**LUBRIKIT**  
Single-dose lubricant for housing o-ring

## High efficiency pre-filter cartridges with Antimicrobial Product Protection

### SEDIMENT

ANTIMICROBIAL TECHNOLOGY



**PP STRING WOUND**  
FILTER 25 micron

PP string-wound filter with Antimicrobial Product Protection Technology: filtration of sand, scales, lime, rust, particles. Life-span: 6 months. Max temperature: 45°C (113°F).

### SEDIMENT

ANTIMICROBIAL TECHNOLOGY



**PP MELT BLOWN**  
FILTER 5 micron

PP melt-blown filter with Antimicrobial Product Protection Technology: filtration of sand, scales, lime, rust, fine particles. Life-span: 6 months. Max temperature: 45°C (113°F).

### CTO

CHLORINE TASTE ODOR



**CARBON BLOCK**  
FILTER 5 micron

Activated carbon block: filtration of fine particles, rust, lime, sand scales; reduction of chlorine (bad tastes, odors) and chloride pollutants (pesticides, solvents). Life-span: 3-6 months. Max temperature: 45°C (113°F).



10" Sanic cartridges in combination with Sanic housings as complete systems are tested and certified by IAPMO RT against NSF/ANSI 42 for bacteriostasis effect. Components tested and certified by IAPMO RT against NSF/ANSI Standards 42 and 61 for material and structural integrity requirements only. In compliance with Drinking Water Treatment Units regulations, USA and Canada.

## FILTER CARTRIDGES REPLACEMENT KIT



Ask for original replacement filter cartridges with Antimicrobial Product Protection and grant your OASIS DP SANIC RO units the best performances.

- STAGE 1: Sediment filter 25 micron
- STAGE 2: Sediment filter 5 micron
- STAGE 3: CTO Carbon Block filter 5 micron

### UNITS MAJOR FEATURES

- 50 GPD - 1812 RO membrane
- Quick-fit connections
- Shut-off valve (STD and UV models)
- Solenoid valve (PUMP and PUMP-UV models)
- Pressure gauge (F models with frame)
- Min pressure switch
- Max pressure switch
- AIC activated carbon post-filter
- AIM re-mineralizer post-filter
- Installation kit with dedicated tap
- 12 liters (3.2 gallons) metal storage tank
- AC plug 2 pins C type - CEE 7/16 (Europlug)

### COMPONENT VARIANTS AVAILABLE ON DEMAND

- 100 GPD - 1812 RO membrane
- Filmtec 50/100 GPD - 1812 RO membrane
- Lead free dedicated faucet
- 15,14 liters (4 gallons) plastic tank
- AC plugs of different types

### MADE IN ITALY COMPONENTS CERTIFICATIONS



Housings are tested and certified under the most stringent procedures worldwide, in compliance with DM 25 (Italy), with the sanitary certification ACS (France), EAC/Ghostreghistrizia (Russia) and WaterMark (Australia).

### SYMBOL LEGEND



For domestic use



# OASIS DP SANIC

## WORKING CONDITIONS

Max inlet pressure STD model	8 bar (116 psi)	Max working temperature	45°C (113°F)
Min inlet pressure STD model	3 bar (45.5 psi)	Min working temperature	4°C (39.2°F)
Max inlet pressure PUMP model	3 bar (45.5 psi)	Max TDS	1000 ppm
Min inlet pressure PUMP model	0,5 bar (7.2 psi)	Membrane capacity	50 GPD (190 l/day)



## OASIS DP SANIC STD

RO UNIT WITH METAL WALL BRACKET	
CODE	SE6075310
MODEL	OASIS DP TRIO SANIC 50 - STD
RO membrane	50 GPD - 1812

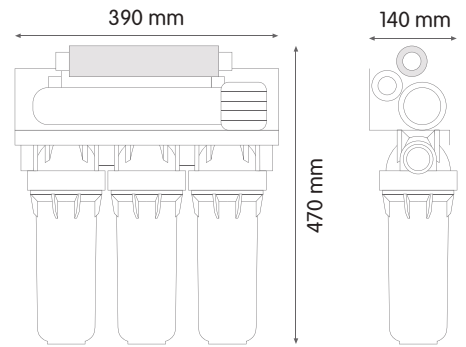

## OASIS DP SANIC PUMP

RO UNIT WITH METAL WALL BRACKET	
CODE	SE6075320
MODEL	OASIS DP TRIO SANIC 50 - PUMP
RO membrane	50 GPD - 1812

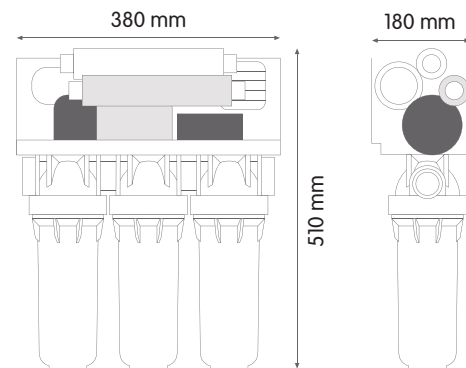

### DIAPHRAGM BOOSTER PUMP

SUPPLY POWER	220/110 V - 50/60 Hz	CE
VOLTAGE	24 V	
AMPERAGE	0,75 A	
POWER	16 W	
FLOW AT 5,5 bar (80 psi)	0,75 l/min (0.19 GPM)	
OPEN FLOW	1 l/min (0.26 GPM)	
MAX OUTPUT PRESSURE	8 bar (116 psi)	



### COMPLETE WITH METAL STORAGE TANK

- 12 liters (3.2 gallons)



**WORKING CONDITIONS**

Max inlet pressure STD model	8 bar (116 psi)	Max working temperature	45°C (113°F)
Min inlet pressure STD model	3 bar (45.5 psi)	Min working temperature	4°C (39.2°F)
Max inlet pressure PUMP model	3 bar (45.5 psi)	Max TDS	1000 ppm
Min inlet pressure PUMP model	0,5 bar (7.2 psi)	Membrane capacity	50 GPD (190 l/day)



**OASIS DP SANIC UV**

**RO UNIT WITH METAL WALL BRACKET**

CODE	SE6075330
MODEL	OASIS DP TRIO SANIC 50 - UV
RO membrane	50 GPD - 1812

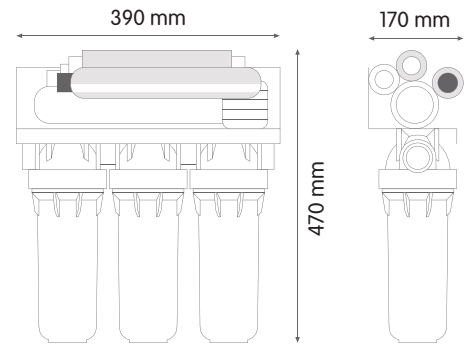

**UV LAMP**

UV-C DOSE	210 J/m <sup>2</sup>
SUPPLY POWER	220/110 V - 50/60 Hz
VOLTAGE	24 V
AMPERAGE	0,16 A
ELECTRICAL ABSORPTION	6 W/h
LAMP SERVICE LIFE	8000 hours



**OASIS DP SANIC PUMP-UV**

**RO UNIT WITH METAL WALL BRACKET**

CODE	SE6075340
MODEL	OASIS DP TRIO SANIC 50 - PUMP-UV
RO membrane	50 GPD - 1812

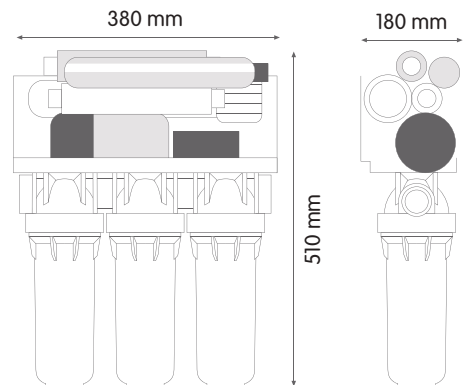

**DIAPHRAGM BOOSTER PUMP**

SUPPLY POWER	220/110 V - 50/60 Hz
VOLTAGE	24 V
AMPERAGE	0,75 A
POWER	16 W
FLOW AT 5,5 bar (80 psi)	0,75 l/min (0.19 GPM)
OPEN FLOW	1 l/min (0.26 GPM)
MAX OUTPUT PRESSURE	8 bar (116 psi)



**UV LAMP**

UV-C DOSE	210 J/m <sup>2</sup>
SUPPLY POWER	220/110 V - 50/60 Hz
VOLTAGE	24 V
AMPERAGE	0,16 A
ELECTRICAL ABSORPTION	6 W/h
LAMP SERVICE LIFE	8000 hours



**COMPLETE WITH METAL STORAGE TANK**

- 12 liters (3.2 gallons)



# OASIS DP-F SANIC

## WORKING CONDITIONS

Max inlet pressure	_____ 3 bar (45.5 psi)	Max working temperature	_____ 45°C (113°F)
Min inlet pressure	_____ 0.5 bar (7.2 psi)	Min working temperature	_____ 4°C (39.2°F)
		Max TDS	_____ 1000 ppm
		Membrane capacity	_____ 50 GPD (190 l/day)



## OASIS DP-F SANIC PUMP

### RO UNIT WITH METAL FRAME

CODE	SE6075350
MODEL	OASIS DP-F TRIO SANIC 50 PUMP
RO membrane	50 GPD - 1812

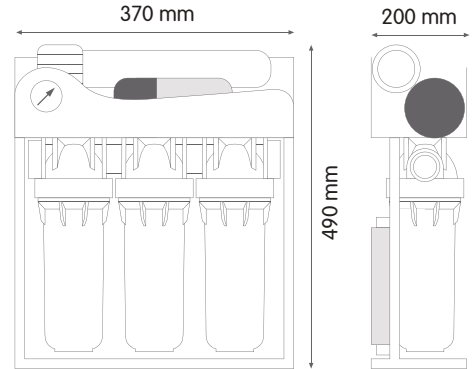

### DIAPHRAGM BOOSTER PUMP

SUPPLY POWER	220/110 V - 50/60 Hz	
VOLTAGE	24 V	
AMPERAGE	0,75 A	
POWER	16 W	
FLOW AT 5,5 bar (80 psi)	0,75 l/min (0.19 GPM)	
OPEN FLOW	1 l/min (0.26 GPM)	
MAX OUTPUT PRESSURE	8 bar (116 psi)	

## OASIS DP-F SANIC PUMP-UV

### RO UNIT WITH METAL FRAME

CODE	SE6075360
MODEL	OASIS DP-F TRIO SANIC 50 PUMP-UV
RO membrane	50 GPD - 1812

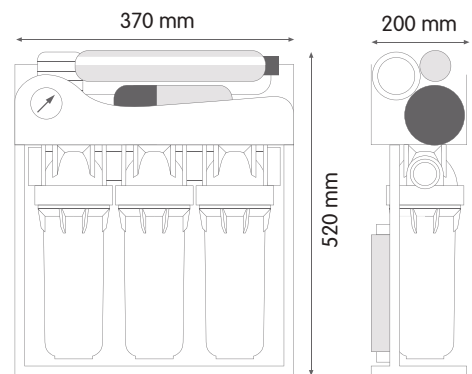

### DIAPHRAGM BOOSTER PUMP

SUPPLY POWER	220/110 V - 50/60 Hz	
VOLTAGE	24 V	
AMPERAGE	0,75 A	
POWER	16 W	
FLOW AT 5,5 bar (80 psi)	0,75 l/min (0.19 GPM)	
OPEN FLOW	1 l/min (0.26 GPM)	
MAX OUTPUT PRESSURE	8 bar (116 psi)	

### UV LAMP

UV-C DOSE	210 J/m <sup>2</sup>	
SUPPLY POWER	220/110 V - 50/60 Hz	
VOLTAGE	24 V	
AMPERAGE	0,16 A	
ELECTRICAL ABSORPTION	6 W/h	
LAMP SERVICE LIFE	8000 hours	



### COMPLETE WITH METAL STORAGE TANK

- 12 liters (3.2 gallons)

DRINKING WATER UNITS





SEDIMENT  
CARTRIDGES

# SEDIMENT FILTRATION

filter cartridges

Extensive range of filter cartridges for every application in water filtration, made with the most appropriate filtering media

# CARTRIDGES CONFIGURATION

FOR FILTERS SX, BX, CX

Atlas Filtri® cartridges for sediment filtration are available in a wide range of end-caps configurations to provide:

- the widest compatibility to housings for cartridges with standard configuration SX with flat seals and double open end (DOE). The major part of housings in the market are suitable to this standard.
- a range of quick-fit double o-ring cartridges with proprietary configurations BX, CX to ensure: perfect watertight fit, safer for micro-filtration, simple and rapid maintenance operations, perfect cartridge standing and elimination of wrong positioning, market exclusivity.



**SX** **Standard double open end (DOE) configuration with antimicrobial flat seals.**  
Fit to SX housings, DP housings, Depural®, Depural® Top, Bravo DP, Oasis DP.



**BX** **Quick-fit configuration with 45 mm double o-ring collar.**  
Fit to Plus 3P BX housings, DP housings, K DP housings, Depural® Top, Bravo DP, Oasis DP.



**CX** **Quick-fit configuration with 57 mm double o-ring collar.**  
Fit to Plus 3P CX and K DP housings.

## TERMS LEGEND

### Filtration

Filter rate in micron.

### Flow rate

In liters per hour (l/h), the flow rate for ideal filtration using a new cartridge.

### Average life-span

The average working life of the cartridge. Working life depends on the type of application, and on the level of filtration, the cartridge material, the type of maintenance that can be carried out and, especially, depends on the quality of the water being treated. The quality of the water is an extremely variable factor and thus the average life-span is indicated for a mains water supply with average European potable water characteristics.

### Maintenance

Type and frequency of applicable maintenance operations.

## CARTRIDGES RANGE

### Cartridges for sediment filtration

#### FILTRATION IN DEPTH

**FA** - wound polypropylene thread.  
Filtration from 1 to 100 micron.

**FA HOT** - wound polypropylene thread with special inner core, for hot water.  
Filtration from 1 to 100 micron.

**CPP** - melt-blown polypropylene smooth.

**PP** - melt-blown polypropylene grooved.

**GA** - quartzite. Filtration 10 micron.

**TS** - polyester fabric. Filtration 50 micron.

**CS** - special paper. Filtration 25 micron.

**AB** - ceramic. Filtration 0,45 micron.

**AC** - polypropylene-borosilicate multi-layer.  
Filtration 0,2 micron and 0,45 micron.

#### NET FILTRATION - WASHABLE CARTRIDGES

**RL** - polyester net. Filtration 50 micron.

**RL C** - polyester net. Filtration 50 micron.

**RL A** - stainless steel net. Filtration 70 micron.

**RA** - stainless steel net. Filtration 70 micron.

**SA** - stainless steel net. Filtration 50 micron.

**RS** - polyester net. Filtration 50 micron.

## SYMBOLS LEGEND



For domestic use



For technical and industrial use



CB-EC cartridges are the only environmentally friendly carbon block element, made with a proprietary technology reducing green house gas emissions in activated carbon production.





# FA polypropylene wound thread

**Sediment filtration.**  
**Average life-span:** 3-6 months.  
**Maintenance:** none.

## WORKING CONDITIONS

Max working temperature \_\_\_\_\_ 45°C (113°F)  
 Min working temperature \_\_\_\_\_ 4°C (39,2°F)

## SPECIFICATIONS

Non-toxic materials, suitable for drinking water.  
 Filter medium: polypropylene thread.  
 Inner core: polypropylene.

A very wide range of filter cartridges made with polypropylene thread wound on polypropylene or reinforced polypropylene inner core, available in a variety of filter rates, heights, diameters and configurations. Wound thread cartridges are a standard as heavy-duty sediment filter to remove scale, sand, lime, rust and other fines for filtration and pre-filtration in residential, commercial, industrial, municipal and other specialized applications. Atlas Filtri FA wound cartridges are made of uniform and consistent polypropylene thread, strong and homogeneous, which makes a compact cartridge construction resulting in a larger filtration surface with improvement in filtration efficiency and in life-span, with a higher cost/effective ratio as a result. The inner core is made rigid and with particular solutions to achieve the maximum rigidity for every height from 4" to 40". FA cartridges are made to comply with the most stringent regulations for applications in drinking water. Polypropylene is suitable to many industrial applications due to its wide chemical-physical compatibility to a variety of water based solutions

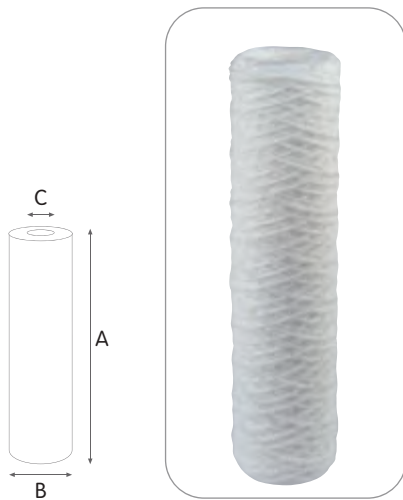

FA cartridges are available in a variety of:

### CONFIGURATIONS:

- SX standard configuration double open end (DOE) available for every height and diameter.
- BX proprietary configuration with double o-ring collar 45 mm, suitable to PLUS 3P BX housings, DP housings, K DP housings.

### MODELS:

- FA MIGNON series 5"M, OD 1.77" ID 0.71". SX configuration
- FA-R series 10", OD 2.20", ID 1.10". SX configuration
- FA series from 4" to 40", OD 2.40", ID 1.10". SX, BX configurations

### VARIANTS AVAILABLE ON MINIMUM QUANTITY:

- FA CX with double o-ring collar 57 mm, suitable to PLUS 3P CX, K DP housings.

### CERTIFICATIONS



FA 10 SX 25 mcr and FA 20 SX 25 mcr cartridges are certified by IAPMO RT to NSF/ANSI 42 - Material Safety Only, 61, 372 - lead free, CSA B483.1 - Material Safety Only. In compliance with Drinking Water Treatment Units regulations, USA and CANADA.



FA cartridges are tested and certified under the most stringent procedures worldwide, in compliance with DM 25 (Italy), with the sanitary certification ACS (France), EAC/Ghostreghistracia (Russia) and WaterMark (Australia).

## FA SX

### WOUND POLYPROPYLENE THREAD CARTRIDGES WITH DOUBLE OPEN END (DOE)

CODE	MODEL	NOMINAL HEIGHT	NOMINAL FILTRATION MICRON	RECOMMENDED FLOW RATE l/h	DIMENSIONS MM		
					A	B	C
<b>OD 1,77" x ID 0,71"</b>							
RE5110408	FA MIGNON SX 5 mcr	5" M	5	500	122	45	18
RE5110409	FA MIGNON SX 10 mcr	5" M	10	500	122	45	18
RE5110411	FA MIGNON SX 25 mcr	5" M	25	500	122	45	18
RE5110414	FA MIGNON SX 50 mcr	5" M	50	500	122	45	18
RE5110419	FA MIGNON SX 100 mcr	5" M	100	500	122	45	18
<b>OD 2,20" x ID 1,10"</b>							
RE5125408	FA 10 R SX 5 mcr	10"	5	1500	250	56	28
RE5125409	FA 10 R SX 10 mcr	10"	10	1500	250	56	28
RE5125411	FA 10 R SX 25 mcr	10"	25	1500	250	56	28
RE5125414	FA 10 R SX 50 mcr	10"	50	1500	250	56	28
<b>OD 2,40" x ID 1,10"</b>							
RE5111406	FA 4 SX 1 mcr	4"	1	800	103	61	28
RE5111408	FA 4 SX 5 mcr	4"	5	800	103	61	28
RE5111409	FA 4 SX 10 mcr	4"	10	800	103	61	28
RE5111411	FA 4 SX 25 mcr	4"	25	800	103	61	28
RE5111414	FA 4 SX 50 mcr	4"	50	800	103	61	28
RE5111419	FA 4 SX 100 mcr	4"	100	800	103	61	28
RE5112406	FA 5 SX 1 mcr	5"	1	1000	125	61	28
RE5112408	FA 5 SX 5 mcr	5"	5	1000	125	61	28
RE5112409	FA 5 SX 10 mcr	5"	10	1000	125	61	28
RE5112411	FA 5 SX 25 mcr	5"	25	1000	125	61	28
RE5112414	FA 5 SX 50 mcr	5"	50	1000	125	61	28
RE5112419	FA 5 SX 100 mcr	5"	100	1000	125	61	28
RE5114406	FA 7 SX 1 mcr	7"	1	1400	173	61	28
RE5114408	FA 7 SX 5 mcr	7"	5	1400	173	61	28
RE5114409	FA 7 SX 10 mcr	7"	10	1400	173	61	28
RE5114411	FA 7 SX 25 mcr	7"	25	1400	173	61	28
RE5114414	FA 7 SX 50 mcr	7"	50	1400	173	61	28
RE5114419	FA 7 SX 100 mcr	7"	100	1400	173	61	28
RE5115406	FA 10 SX 1 mcr	10"	1	2000	250	61	28
RE5115408	FA 10 SX 5 mcr	10"	5	2000	250	61	28
RE5115409	FA 10 SX 10 mcr	10"	10	2000	250	61	28
RE5115411	FA 10 SX 25 mcr	10"	25	2000	250	61	28
RE5115414	FA 10 SX 50 mcr	10"	50	2000	250	61	28
RE5115419	FA 10 SX 100 mcr	10"	100	2000	250	61	28
RE5117406	FA 20 SX 1 mcr	20"	1	3000	505	61	28
RE5117408	FA 20 SX 5 mcr	20"	5	3000	505	61	28
RE5117409	FA 20 SX 10 mcr	20"	10	3000	505	61	28
RE5117411	FA 20 SX 25 mcr	20"	25	3000	505	61	28
RE5117414	FA 20 SX 50 mcr	20"	50	3000	505	61	28
RE5117419	FA 20 SX 100 mcr	20"	100	3000	505	61	28
RE5118406	FA 30 SX 1 mcr	30"	1	4000	755	61	28
RE5118408	FA 30 SX 5 mcr	30"	5	4000	755	61	28
RE5118409	FA 30 SX 10 mcr	30"	10	4000	755	61	28
RE5118411	FA 30 SX 25 mcr	30"	25	4000	755	61	28
RE5118414	FA 30 SX 50 mcr	30"	50	4000	755	61	28
RE5118419	FA 30 SX 100 mcr	30"	100	4000	755	61	28
RE5119406	FA 40 SX 1 mcr	40"	1	5000	1015	61	28
RE5119408	FA 40 SX 5 mcr	40"	5	5000	1015	61	28
RE5119409	FA 40 SX 10 mcr	40"	10	5000	1015	61	28
RE5119411	FA 40 SX 25 mcr	40"	25	5000	1015	61	28
RE5119414	FA 40 SX 50 mcr	40"	50	5000	1015	61	28
RE5119419	FA 40 SX 100 mcr	40"	100	5000	1015	61	28

SEDIMENT CARTRIDGES



**Sediment filtration.**  
**Average life-span:** 3-6 months.  
**Maintenance:** none.

**WORKING CONDITIONS**

Max working temperature \_\_\_\_\_ 45°C (113°F)  
 Min working temperature \_\_\_\_\_ 4°C (39,2°F)

**SPECIFICATIONS**

Non-toxic materials, suitable for drinking water.  
 Filter medium: polypropylene thread.  
 Inner core: polypropylene.  
 O-rings: EPDM.

**FA BX**

**WOUND POLYPROPYLENE THREAD CARTRIDGES WITH DOUBLE O-RING COLLAR 45 MM**

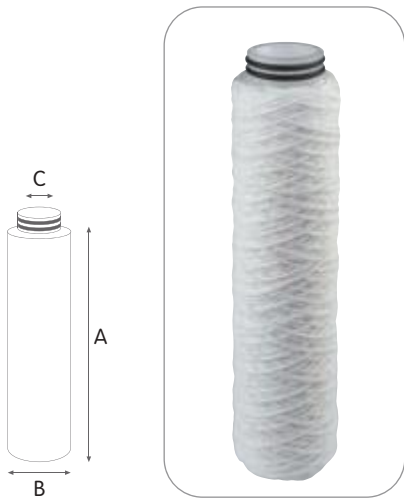

CODE	MODEL	NOMINAL HEIGHT	NOMINAL FILTRATION MICRON	RECOMMENDED FLOW RATE l/h	DIMENSIONS MM		
					A	B	C
<b>OD 2,40" x ID 1,10"</b>							
RA5112206	FA 5 BX 1 mcr	5"	1	1000	125	61	30
RA5112208	FA 5 BX 5 mcr	5"	5	1000	125	61	30
RA5112209	FA 5 BX 10 mcr	5"	10	1000	125	61	30
RA5112211	FA 5 BX 25 mcr	5"	25	1000	125	61	30
RA5112214	FA 5 BX 50 mcr	5"	50	1000	125	61	30
RA5112219	FA 5 BX 100 mcr	5"	100	1000	125	61	30
RA5114206	FA 7 BX 1 mcr	7"	1	1400	173	61	30
RA5114208	FA 7 BX 5 mcr	7"	5	1400	173	61	30
RA5114209	FA 7 BX 10 mcr	7"	10	1400	173	61	30
RA5114211	FA 7 BX 25 mcr	7"	25	1400	173	61	30
RA5114214	FA 7 BX 50 mcr	7"	50	1400	173	61	30
RA5114219	FA 7 BX 100 mcr	7"	100	1400	173	61	30
RA5115206	FA 10 BX 1 mcr	10"	1	2000	250	61	30
RA5115208	FA 10 BX 5 mcr	10"	5	2000	250	61	30
RA5115209	FA 10 BX 10 mcr	10"	10	2000	250	61	30
RA5115211	FA 10 BX 25 mcr	10"	25	2000	250	61	30
RA5115214	FA 10 BX 50 mcr	10"	50	2000	250	61	30
RA5115219	FA 10 BX 100 mcr	10"	100	2000	250	61	30
RA5117206	FA 20 BX 1 mcr	20"	1	3000	505	61	25
RA5117208	FA 20 BX 5 mcr	20"	5	3000	505	61	25
RA5117209	FA 20 BX 10 mcr	20"	10	3000	505	61	25
RA5117211	FA 20 BX 25 mcr	20"	25	3000	505	61	25
RA5117214	FA 20 BX 50 mcr	20"	50	3000	505	61	25
RA5117219	FA 20 BX 100 mcr	20"	100	3000	505	61	25

**FLOW RATE vs PRESSURE DROP Δp**

Tests carried on 10" elements type **FA 10 SX**.  
 Testing mode: 20°C, 3 BAR

- 1 micron —
- 5 micron —
- 10 micron —
- 25 micron —
- 50 micron —
- 100 micron —

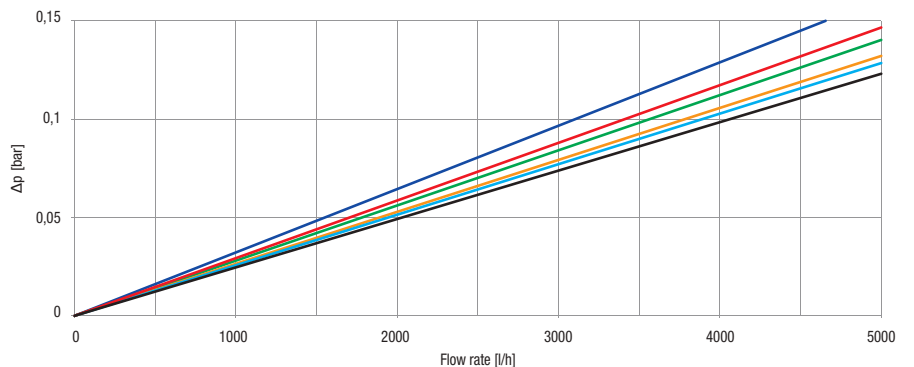



# FA BIG polypropylene wound thread

**Sediment filtration.**  
**Average life-span:** 3-6 months.  
**Maintenance:** none.

**WORKING CONDITIONS**

Max working temperature \_\_\_\_\_ 45°C (113°F)  
 Min working temperature \_\_\_\_\_ 4°C (39,2°F)

**SPECIFICATIONS**

Non-toxic materials, suitable for drinking water.  
 Filter medium: polypropylene thread.  
 Inner core: polypropylene.

A range of 4.50" OD filter cartridges made with polypropylene thread wound on polypropylene inner core, designed to fit to DP BIG housings and respond to the most effective heavy-duty sediment filtration requirements, suitable to industrial as well as domestic applications. Atlas Filtri FA BIG wound cartridges are made of uniform and consistent polypropylene thread, strong and homogeneous, which makes a compact cartridge construction resulting in a larger filtration surface with improvement in filtration efficiency and in life-span, with a higher cost/effective ratio as a result. FA BIG at height 10" and 20" are available with single layer filtration and with multi-layer filtration, providing progressive filtration in depth for efficiency improvement.



## FA BIG SX

**WOUND POLYPROPYLENE THREAD CARTRIDGES WITH DOUBLE OPEN END (DOE)**

CODE	MODEL	NOMINAL HEIGHT	NOMINAL FILTRATION MICRON	RECOMMENDED FLOW RATE l/h	DIMENSIONS MM		
					A	B	C
<b>OD 4,50" x ID 1,10"</b>							
RE5115506	FA 10 BIG SX 1 mcr	10"	1	2500	250	110	28
RE5115508	FA 10 BIG SX 5 mcr	10"	5	2500	250	110	28
RE5115509	FA 10 BIG SX 10 mcr	10"	10	2500	250	110	28
RE5115511	FA 10 BIG SX 25 mcr	10"	25	2500	250	110	28
RE5115514	FA 10 BIG SX 50 mcr	10"	50	2500	250	110	28
RE5115519	FA 10 BIG SX 100 mcr	10"	100	2500	250	110	28
RE5117506	FA 20 BIG SX 1 mcr	20"	1	4000	508	110	28
RE5117508	FA 20 BIG SX 5 mcr	20"	5	4000	508	110	28
RE5117509	FA 20 BIG SX 10 mcr	20"	10	4000	508	110	28
RE5117511	FA 20 BIG SX 25 mcr	20"	25	4000	508	110	28
RE5117514	FA 20 BIG SX 50 mcr	20"	50	4000	508	110	28
RE5117519	FA 20 BIG SX 100 mcr	20"	100	4000	508	110	28

## FA BIG MULTI LAYER SX

**WOUND POLYPROPYLENE THREAD CARTRIDGES WITH DOUBLE OPEN END (DOE)**

CODE	MODEL	NOMINAL HEIGHT	NOMINAL FILTRATION MICRON	RECOMMENDED FLOW RATE l/h	DIMENSIONS MM		
					A	B	C
<b>OD 4,50" x ID 1,10"</b>							
RE5115520	FA 10 BIG MULTI LAYER SX 10 1 mcr	10"	10 - 1	2500	250	110	28
RE5115521	FA 10 BIG MULTI LAYER SX 25 1 mcr	10"	25 - 1	2500	250	110	28
RE5115522	FA 10 BIG MULTI LAYER SX 50 5 mcr	10"	50 - 5	2500	250	110	28
RE5115523	FA 10 BIG MULTI LAYER SX 50 10 mcr	10"	50 - 10	2500	250	110	28
RE5115528	FA 10 BIG MULTI LAYER SX 100 25 mcr	10"	100 - 25	2500	250	110	28
RE5115529	FA 10 BIG MULTI LAYER SX 100 50 mcr	10"	100 - 50	2500	250	110	28
RE5117520	FA 20 BIG MULTI LAYER SX 10 1 mcr	20"	10 - 1	4000	508	110	28
RE5117521	FA 20 BIG MULTI LAYER SX 25 1 mcr	20"	25 - 1	4000	508	110	28
RE5117522	FA 20 BIG MULTI LAYER SX 50 5 mcr	20"	50 - 5	4000	508	110	28
RE5117523	FA 20 BIG MULTI LAYER SX 50 10 mcr	20"	50 - 10	4000	508	110	28
RE5117528	FA 20 BIG MULTI LAYER SX 100 25 mcr	20"	100 - 25	4000	508	110	28
RE5117529	FA 20 BIG MULTI LAYER SX 100 50 mcr	20"	100 - 50	4000	508	110	28

FA BIG cartridges are available in a variety of:

**CONFIGURATIONS:**

- SX standard configuration double open end (DOE) available for every height and diameter.

**MODELS:**

- FA BIG series 10" and 20", OD 4.50", ID 1.10". SX configuration
- FA BIG MULTI-LAYER series 10" and 20", OD 4.50", ID 1.10". SX configuration

**CERTIFICATIONS**



FA 10 BIG SX 25 mcr and FA 20 BIG SX 25 mcr cartridges are certified by IAPMO RT to NSF/ANSI 42 - Material Safety Only, 61, 372 - lead free, CSA B483.1 - Material Safety Only. In compliance with Drinking Water Treatment Units regulations, USA and CANADA.



FA BIG cartridges are tested and certified under the most stringent procedures worldwide, in compliance with DM 25 (Italy), with the sanitary certification EAC/Ghostreghistracia (Russia) and WaterMark (Australia).

**FLOW RATE vs PRESSURE DROP Δp**

Tests carried on 10" elements type FA 10 BIG SX.  
 Testing mode: 20°C, 3 BAR

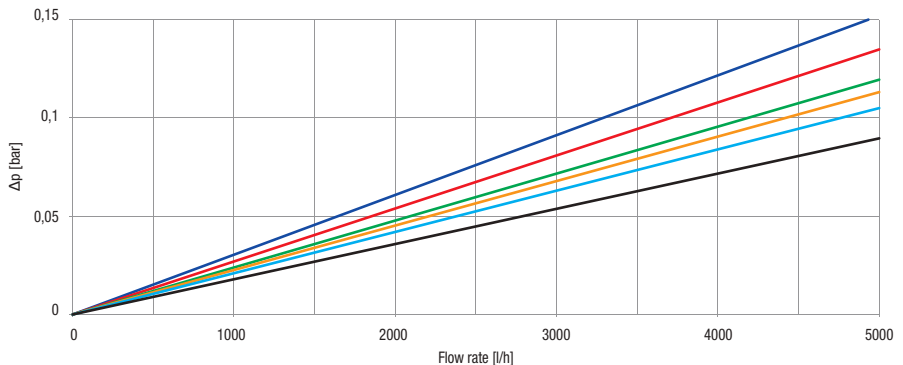

Some items in the list are subject to minimum order quantities and/or to longer delivery term.

SEDIMENT CARTRIDGES



# FA HOT wound thread for hot water

**Sediment filtration.**  
**Average life-span:** 3-6 months.  
**Maintenance:** none.

## WORKING CONDITIONS

Max working temperature \_\_\_\_\_ 80°C (176°F)  
 Min working temperature \_\_\_\_\_ 4°C (39,2°F)

## SPECIFICATIONS

Non-toxic materials, suitable for drinking water.  
 Filter medium: polypropylene thread.  
 Inner core: reinforced polypropylene.

A range of filter cartridges made with polypropylene thread wound on reinforced polypropylene inner core especially designed for application with hot water, available in a variety of filter rates and heights.

Thanks to the special inner-core material, FA HOT cartridges are applicable for use in hot water as heavy-duty sediment filter to remove scale, sand, lime, rust and other fines for filtration and pre-filtration in residential, commercial, industrial, municipal and other specialized applications.  
 FA HOT are available in SX configuration for cartridge height 5", 7", 10", 20".

## FA HOT SX

### WOUND POLYPROPYLENE THREAD CARTRIDGES WITH DOUBLE OPEN END (DOE)

CODE	MODEL	NOMINAL HEIGHT	NOMINAL FILTRATION MICRON	RECOMMENDED FLOW RATE l/h	DIMENSIONS MM		
					A	B	C
<b>OD 2,40" x ID 1,10"</b>							
RE5382106	FA HOT 5 SX 1 mcr	5"	1	1000	125	61	28
RE5382108	FA HOT 5 SX 5 mcr	5"	5	1000	125	61	28
RE5382109	FA HOT 5 SX 10 mcr	5"	10	1000	125	61	28
RE5382111	FA HOT 5 SX 25 mcr	5"	25	1000	125	61	28
RE5382114	FA HOT 5 SX 50 mcr	5"	50	1000	125	61	28
RE5382119	FA HOT 5 SX 100 mcr	5"	100	1000	125	61	28
RE5384106	FA HOT 7 SX 1 mcr	7"	1	1400	173	61	28
RE5384108	FA HOT 7 SX 5 mcr	7"	5	1400	173	61	28
RE5384109	FA HOT 7 SX 10 mcr	7"	10	1400	173	61	28
RE5384111	FA HOT 7 SX 25 mcr	7"	25	1400	173	61	28
RE5384114	FA HOT 7 SX 50 mcr	7"	50	1400	173	61	28
RE5384119	FA HOT 7 SX 100 mcr	7"	100	1400	173	61	28
RE5385106	FA HOT 10 SX 1 mcr	10"	1	2000	250	61	28
RE5385108	FA HOT 10 SX 5 mcr	10"	5	2000	250	61	28
RE5385109	FA HOT 10 SX 10 mcr	10"	10	2000	250	61	28
RE5385111	FA HOT 10 SX 25 mcr	10"	25	2000	250	61	28
RE5385114	FA HOT 10 SX 50 mcr	10"	50	2000	250	61	28
RE5385119	FA HOT 10 SX 100 mcr	10"	100	2000	250	61	28
RE5387106	FA HOT 20 SX 1 mcr	20"	1	3000	505	61	28
RE5387108	FA HOT 20 SX 5 mcr	20"	5	3000	505	61	28
RE5387109	FA HOT 20 SX 10 mcr	20"	10	3000	505	61	28
RE5387111	FA HOT 20 SX 25 mcr	20"	25	3000	505	61	28
RE5387114	FA HOT 20 SX 50 mcr	20"	50	3000	505	61	28
RE5387119	FA HOT 20 SX 100 mcr	20"	100	3000	505	61	28

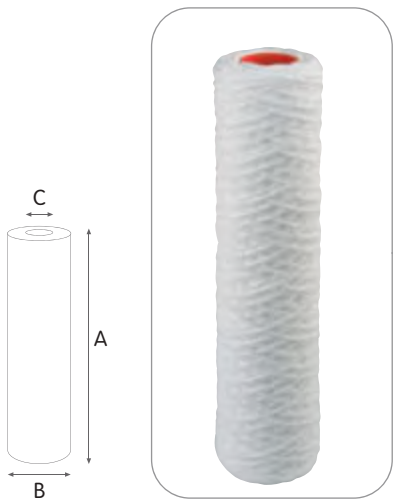

### FLOW RATE vs PRESSURE DROP $\Delta p$

Tests carried on 10" elements type **FA HOT 10 SX**.  
 Testing mode: 20°C, 3 BAR

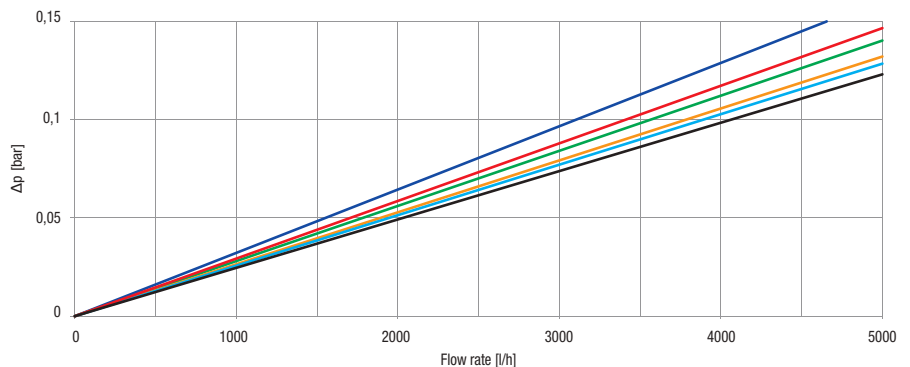

### CERTIFICATIONS



FA HOT cartridges are tested and certified under the most stringent procedures worldwide, in compliance with DM 25 (Italy), with the sanitary certification EAC/Ghostreghistracia (Russia) and WaterMark (Australia).



# CPP melt-blown polypropylene

**Sediment filtration.**  
**Average life-span:** 3-6 months.  
**Maintenance:** none.

## WORKING CONDITIONS

Max working temperature \_\_\_\_\_ 80°C (176°F)  
 Min working temperature \_\_\_\_\_ 4°C (39,2°F)

## SPECIFICATIONS

Non-toxic materials, suitable for drinking water.  
 Filter medium: polypropylene.

Atlas Filtri high efficiency melt-blown polypropylene cartridges are manufactured in specific plant which includes the standardization of production with dedicated software at every process' stage, thermal insulation at controlled temperature, full automation of the whole production line, from the raw-material loading to the finished product packing, without operator direct contact with the product, granting full hygienic safety. Certified raw materials, high productivity and quick delivery time, flexibility of production and custom made products complete the benefits of the range. CPP smooth cartridges with heights from 4" to 50" are available also as IC models with polypropylene inner core and as E models with end-caps in various configurations.

CPP cartridges are made to comply with the most stringent regulations for applications in drinking water. Polypropylene is suitable to many industrial applications due to its wide chemical-physical compatibility to a variety of water-based solutions.

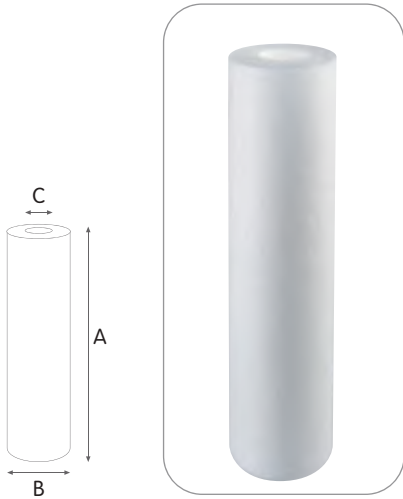

CPP are available in a variety of:

### CONFIGURATIONS:

- SX standard configuration double open end (DOE) available for every height and diameter.
- BX proprietary configuration with double o-ring collar 45 mm, suitable to PLUS 3P BX housings, DP housings, K DP housings.

Other end-caps configurations (code C8, C7, P8) available on demand by minimum quantity.

### MODELS:

- CPP MIGNON series 5" M OD 1.77" ID 0.71, SX configuration, available on demand by minimum quantity.
- CPP series from 4" to 50" OD 2.40" ID 1.10", SX, BX configurations, other end-caps configurations available on demand by minimum quantity.

### VARIANTS AVAILABLE ON MINIMUM QUANTITY:

- CPP CX with double o-ring collar 57 mm, suitable to PLUS 3P CX, K DP housings.
- CPP-R series 10" and 20" OD 2.20" ID 1.10", SX configuration.

### CERTIFICATIONS



CPP 10 SX 5 mcr and CPP 20 SX 5 mcr cartridges are certified by IAPMO RT to NSF/ANSI 42 - Material Safety Only, 61, 372 - lead free, CSA B483.1 - Material Safety Only. In compliance with Drinking Water Treatment Units regulations, USA and CANADA.



CPP cartridges are tested and certified under the most stringent procedures worldwide, in compliance with DM 25 (Italy), with the sanitary certification ACS (France), EAC/Ghostreghistrizia (Russia) and WaterMark (Australia).

## CPP SX

### POLYPROPYLENE MELT-BLOWN SMOOTH CARTRIDGES WITH DOUBLE OPEN END (DOE)

CODE	MODEL	NOMINAL HEIGHT	NOMINAL FILTRATION MICRON	RECOMMENDED FLOW RATE l/h	DIMENSIONS MM A	B	C
<b>OD 2,40" x ID 1,10"</b>							
RA5703506	CPP 4 SX 1 mcr	4"	1	800	101	61	28
RA5703508	CPP 4 SX 5 mcr	4"	5	800	101	61	28
RA5703509	CPP 4 SX 10 mcr	4"	10	800	101	61	28
RA5703511	CPP 4 SX 25 mcr	4"	25	800	101	61	28
RA5703514	CPP 4 SX 50 mcr	4"	50	800	101	61	28
RA5704506	CPP 5 SX 1 mcr	5"	1	1000	125	61	28
RA5704508	CPP 5 SX 5 mcr	5"	5	1000	125	61	28
RA5704509	CPP 5 SX 10 mcr	5"	10	1000	125	61	28
RA5704511	CPP 5 SX 25 mcr	5"	25	1000	125	61	28
RA5704514	CPP 5 SX 50 mcr	5"	50	1000	125	61	28
RA5705506	CPP 7 SX 1 mcr	7"	1	1400	173	61	28
RA5705508	CPP 7 SX 5 mcr	7"	5	1400	173	61	28
RA5705509	CPP 7 SX 10 mcr	7"	10	1400	173	61	28
RA5705511	CPP 7 SX 25 mcr	7"	25	1400	173	61	28
RA5705514	CPP 7 SX 50 mcr	7"	50	1400	173	61	28
RA5706506	CPP 10 SX 1 mcr	10"	1	2000	250	61	28
RA5706508	CPP 10 SX 5 mcr	10"	5	2000	250	61	28
RA5706509	CPP 10 SX 10 mcr	10"	10	2000	250	61	28
RA5706511	CPP 10 SX 25 mcr	10"	25	2000	250	61	28
RA5706514	CPP 10 SX 50 mcr	10"	50	2000	250	61	28
RA5706706	CPP 20 SX 1 mcr	20"	1	3000	505	61	28
RA5706708	CPP 20 SX 5 mcr	20"	5	3000	505	61	28
RA5706709	CPP 20 SX 10 mcr	20"	10	3000	505	61	28
RA5706711	CPP 20 SX 25 mcr	20"	25	3000	505	61	28
RA5706714	CPP 20 SX 50 mcr	20"	50	3000	505	61	28
RA5706806	CPP 30 SX 1 mcr	30"	1	4000	762	61	28
RA5706808	CPP 30 SX 5 mcr	30"	5	4000	762	61	28
RA5706809	CPP 30 SX 10 mcr	30"	10	4000	762	61	28
RA5706811	CPP 30 SX 25 mcr	30"	25	4000	762	61	28
RA5706814	CPP 30 SX 50 mcr	30"	50	4000	762	61	28
RA5708506	CPP 40 SX 1 mcr	40"	1	5000	1016	61	28
RA5708508	CPP 40 SX 5 mcr	40"	5	5000	1016	61	28
RA5708509	CPP 40 SX 10 mcr	40"	10	5000	1016	61	28
RA5708511	CPP 40 SX 25 mcr	40"	25	5000	1016	61	28
RA5708514	CPP 40 SX 50 mcr	40"	50	5000	1016	61	28
RA5709506	CPP 50 SX 1 mcr	50"	1	6000	1270	61	28
RA5709508	CPP 50 SX 5 mcr	50"	5	6000	1270	61	28
RA5709509	CPP 50 SX 10 mcr	50"	10	6000	1270	61	28
RA5709511	CPP 50 SX 25 mcr	50"	25	6000	1270	61	28
RA5709514	CPP 50 SX 50 mcr	50"	50	6000	1270	61	28

SEDIMENT CARTRIDGES

Some items in the list are subject to minimum order quantities and/or to longer delivery term.

**Sediment filtration.**  
**Average life-span:** 3-6 months.  
**Maintenance:** none.



**WORKING CONDITIONS**

Max working temperature \_\_\_\_\_ 80°C (176°F)  
 Min working temperature \_\_\_\_\_ 4°C (39,2°F)

**SPECIFICATIONS**

Non-toxic materials, suitable for drinking water.  
 Filter medium: polypropylene.  
 Inner core: polypropylene.

**CPP-IC SX**

**POLYPROPYLENE MELT-BLOWN SMOOTH CARTRIDGES WITH INNER CORE WITH DOUBLE OPEN END (DOE)**

CODE	MODEL	NOMINAL HEIGHT	NOMINAL FILTRATION MICRON	RECOMMENDED FLOW RATE l/h	DIMENSIONS MM		
					A	B	C
<b>OD 2,40" x ID 1,10"</b>							
RA5903506	CPP-IC 4 SX 1 mcr	4"	1	800	101	61	28
RA5903508	CPP-IC 4 SX 5 mcr	4"	5	800	101	61	28
RA5903509	CPP-IC 4 SX 10 mcr	4"	10	800	101	61	28
RA5903511	CPP-IC 4 SX 25 mcr	4"	25	800	101	61	28
RA5903514	CPP-IC 4 SX 50 mcr	4"	50	800	101	61	28
RA5904506	CPP-IC 5 SX 1 mcr	5"	1	1000	125	61	28
RA5904508	CPP-IC 5 SX 5 mcr	5"	5	1000	125	61	28
RA5904509	CPP-IC 5 SX 10 mcr	5"	10	1000	125	61	28
RA5904511	CPP-IC 5 SX 25 mcr	5"	25	1000	125	61	28
RA5904514	CPP-IC 5 SX 50 mcr	5"	50	1000	125	61	28
RA5905506	CPP-IC 7 SX 1 mcr	7"	1	1400	173	61	28
RA5905508	CPP-IC 7 SX 5 mcr	7"	5	1400	173	61	28
RA5905509	CPP-IC 7 SX 10 mcr	7"	10	1400	173	61	28
RA5905511	CPP-IC 7 SX 25 mcr	7"	25	1400	173	61	28
RA5905514	CPP-IC 7 SX 50 mcr	7"	50	1400	173	61	28
RA5906506	CPP-IC 10 SX 1 mcr	10"	1	2000	250	61	28
RA5906508	CPP-IC 10 SX 5 mcr	10"	5	2000	250	61	28
RA5906509	CPP-IC 10 SX 10 mcr	10"	10	2000	250	61	28
RA5906511	CPP-IC 10 SX 25 mcr	10"	25	2000	250	61	28
RA5906514	CPP-IC 10 SX 50 mcr	10"	50	2000	250	61	28
RA5906706	CPP-IC 20 SX 1 mcr	20"	1	3000	505	61	28
RA5906708	CPP-IC 20 SX 5 mcr	20"	5	3000	505	61	28
RA5906709	CPP-IC 20 SX 10 mcr	20"	10	3000	505	61	28
RA5906711	CPP-IC 20 SX 25 mcr	20"	25	3000	505	61	28
RA5906714	CPP-IC 20 SX 50 mcr	20"	50	3000	505	61	28
RA5906806	CPP-IC 30 SX 1 mcr	30"	1	4000	762	61	28
RA5906808	CPP-IC 30 SX 5 mcr	30"	5	4000	762	61	28
RA5906809	CPP-IC 30 SX 10 mcr	30"	10	4000	762	61	28
RA5906811	CPP-IC 30 SX 25 mcr	30"	25	4000	762	61	28
RA5906814	CPP-IC 30 SX 50 mcr	30"	50	4000	762	61	28
RA5908506	CPP-IC 40 SX 1 mcr	40"	1	5000	1016	61	28
RA5908508	CPP-IC 40 SX 5 mcr	40"	5	5000	1016	61	28
RA5908509	CPP-IC 40 SX 10 mcr	40"	10	5000	1016	61	28
RA5908511	CPP-IC 40 SX 25 mcr	40"	25	5000	1016	61	28
RA5908514	CPP-IC 40 SX 50 mcr	40"	50	5000	1016	61	28
RA5909506	CPP-IC 50 SX 1 mcr	50"	1	6000	1270	61	28
RA5909508	CPP-IC 50 SX 5 mcr	50"	5	6000	1270	61	28
RA5909509	CPP-IC 50 SX 10 mcr	50"	10	6000	1270	61	28
RA5909511	CPP-IC 50 SX 25 mcr	50"	25	6000	1270	61	28
RA5909514	CPP-IC 50 SX 50 mcr	50"	50	6000	1270	61	28

Some items in the list are subject to minimum order quantities and/or to longer delivery term.

**Sediment filtration.**  
**Average life-span:** 3-6 months.  
**Maintenance:** none.

**WORKING CONDITIONS**

Max working temperature \_\_\_\_\_ 80°C (176°F)  
 Min working temperature \_\_\_\_\_ 4°C (39,2°F)

**SPECIFICATIONS**

Non-toxic materials, suitable for drinking water.  
 Filter medium: polypropylene.  
 Inner core: polypropylene.  
 End caps: polypropylene.  
 Flat seals: SEBS with antimicrobial technology.

**CPP-E SX**

**POLYPROPYLENE MELT-BLOWN SMOOTH CARTRIDGES WITH END CAPS WITH DOUBLE OPEN END (DOE)**

CODE	MODEL	NOMINAL HEIGHT	NOMINAL FILTRATION MICRON	RECOMMENDED FLOW RATE l/h	DIMENSIONS MM		
					A	B	C
<b>OD 2,40" x ID 1,10"</b>							
RA5710408	CPP-E MIGNON SX 5 mcr	5" M	5	500	122	50	20
RA5710411	CPP-E MIGNON SX 25 mcr	5" M	25	500	122	50	20
RA5703516	CPP-E 4 SX 1 mcr	4"	1	800	101	70	28
RA5703518	CPP-E 4 SX 5 mcr	4"	5	800	101	70	28
RA5703519	CPP-E 4 SX 10 mcr	4"	10	800	101	70	28
RA5703521	CPP-E 4 SX 25 mcr	4"	25	800	101	70	28
RA5703524	CPP-E 4 SX 50 mcr	4"	50	800	101	70	28
RA5704516	CPP-E 5 SX 1 mcr	5"	1	1000	125	70	28
RA5704518	CPP-E 5 SX 5 mcr	5"	5	1000	125	70	28
RA5704519	CPP-E 5 SX 10 mcr	5"	10	1000	125	70	28
RA5704521	CPP-E 5 SX 25 mcr	5"	25	1000	125	70	28
RA5704524	CPP-E 5 SX 50 mcr	5"	50	1000	125	70	28
RA5705516	CPP-E 7 SX 1 mcr	7"	1	1400	173	70	28
RA5705518	CPP-E 7 SX 5 mcr	7"	5	1400	173	70	28
RA5705519	CPP-E 7 SX 10 mcr	7"	10	1400	173	70	28
RA5705521	CPP-E 7 SX 25 mcr	7"	25	1400	173	70	28
RA5705524	CPP-E 7 SX 50 mcr	7"	50	1400	173	70	28
RA5706516	CPP-E 10 SX 1 mcr	10"	1	2000	250	70	28
RA5706518	CPP-E 10 SX 5 mcr	10"	5	2000	250	70	28
RA5706519	CPP-E 10 SX 10 mcr	10"	10	2000	250	70	28
RA5706521	CPP-E 10 SX 25 mcr	10"	25	2000	250	70	28
RA5706524	CPP-E 10 SX 50 mcr	10"	50	2000	250	70	28
RA5706716	CPP-E 20 SX 1 mcr	20"	1	3000	505	70	28
RA5706718	CPP-E 20 SX 5 mcr	20"	5	3000	505	70	28
RA5706719	CPP-E 20 SX 10 mcr	20"	10	3000	505	70	28
RA5706721	CPP-E 20 SX 25 mcr	20"	25	3000	505	70	28
RA5706724	CPP-E 20 SX 50 mcr	20"	50	3000	505	70	28
RA5706816	CPP-E 30 SX 1 mcr	30"	1	4000	762	70	28
RA5706818	CPP-E 30 SX 5 mcr	30"	5	4000	762	70	28
RA5706819	CPP-E 30 SX 10 mcr	30"	10	4000	762	70	28
RA5706821	CPP-E 30 SX 25 mcr	30"	25	4000	762	70	28
RA5706824	CPP-E 30 SX 50 mcr	30"	50	4000	762	70	28
RA5708516	CPP-E 40 SX 1 mcr	40"	1	5000	1016	70	28
RA5708518	CPP-E 40 SX 5 mcr	40"	5	5000	1016	70	28
RA5708519	CPP-E 40 SX 10 mcr	40"	10	5000	1016	70	28
RA5708521	CPP-E 40 SX 25 mcr	40"	25	5000	1016	70	28
RA5708524	CPP-E 40 SX 50 mcr	40"	50	5000	1016	70	28
RA5709516	CPP-E 50 SX 1 mcr	50"	1	6000	1270	70	28
RA5709518	CPP-E 50 SX 5 mcr	50"	5	6000	1270	70	28
RA5709519	CPP-E 50 SX 10 mcr	50"	10	6000	1270	70	28
RA5709521	CPP-E 50 SX 25 mcr	50"	25	6000	1270	70	28
RA5709524	CPP-E 50 SX 50 mcr	50"	50	6000	1270	70	28

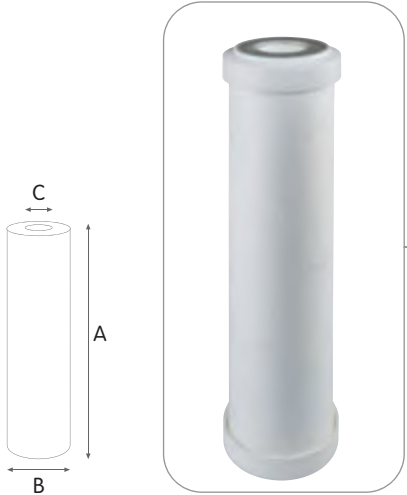

SEDIMENT CARTRIDGES

Some items in the list are subject to minimum order quantities and/or to longer delivery term.



**Sediment filtration.**  
**Average life-span:** 3-6 months.  
**Maintenance:** none.

**WORKING CONDITIONS**

Max working temperature \_\_\_\_\_ 80°C (176°F)  
 Min working temperature \_\_\_\_\_ 4°C (39,2°F)

**SPECIFICATIONS**

Non-toxic materials, suitable for drinking water.  
 Filter medium: polypropylene.  
 End caps: polypropylene.  
 O-rings: EPDM.

**CPP BX**

**POLYPROPYLENE MELT-BLOWN SMOOTH CARTRIDGES WITH DOUBLE O-RING COLLAR 45 MM**

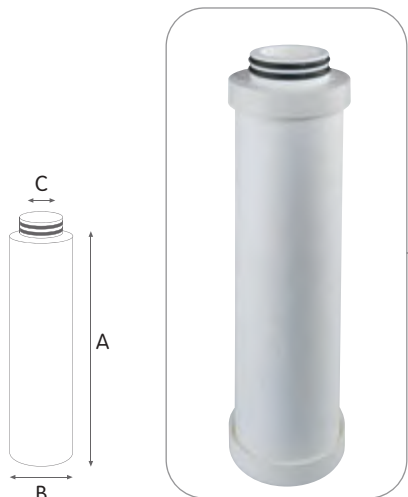

CODE	MODEL	NOMINAL HEIGHT	NOMINAL FILTRATION MICRON	RECOMMENDED FLOW RATE l/h	DIMENSIONS MM		
					A	B	C
<b>OD 2,40" x ID 1,10"</b>							
RA5742206	CPP 5 BX 1 mcr	5"	1	1000	125	70	25
RA5742208	CPP 5 BX 5 mcr	5"	5	1000	125	70	25
RA5742209	CPP 5 BX 10 mcr	5"	10	1000	125	70	25
RA5742211	CPP 5 BX 25 mcr	5"	25	1000	125	70	25
RA5742214	CPP 5 BX 50 mcr	5"	50	1000	125	70	25
RA5744206	CPP 7 BX 1 mcr	7"	1	1400	179	70	25
RA5744208	CPP 7 BX 5 mcr	7"	5	1400	179	70	25
RA5744209	CPP 7 BX 10 mcr	7"	10	1400	179	70	25
RA5744211	CPP 7 BX 25 mcr	7"	25	1400	179	70	25
RA5744214	CPP 7 BX 50 mcr	7"	50	1400	179	70	25
RA5745206	CPP 10 BX 1 mcr	10"	1	2000	250	70	25
RA5745208	CPP 10 BX 5 mcr	10"	5	2000	250	70	25
RA5745209	CPP 10 BX 10 mcr	10"	10	2000	250	70	25
RA5745211	CPP 10 BX 25 mcr	10"	25	2000	250	70	25
RA5745214	CPP 10 BX 50 mcr	10"	50	2000	250	70	25
RA5747206	CPP 20 BX 1 mcr	20"	1	3000	505	70	25
RA5747208	CPP 20 BX 5 mcr	20"	5	3000	505	70	25
RA5747209	CPP 20 BX 10 mcr	20"	10	3000	505	70	25
RA5747211	CPP 20 BX 25 mcr	20"	25	3000	505	70	25
RA5747214	CPP 20 BX 50 mcr	20"	50	3000	505	70	25
RA5748206	CPP 30 BX 1 mcr	30"	1	4000	762	70	25
RA5748208	CPP 30 BX 5 mcr	30"	5	4000	762	70	25
RA5748209	CPP 30 BX 10 mcr	30"	10	4000	762	70	25
RA5748211	CPP 30 BX 25 mcr	30"	25	4000	762	70	25
RA5748214	CPP 30 BX 50 mcr	30"	50	4000	762	70	25
RA5749206	CPP 40 BX 1 mcr	40"	1	5000	1016	70	25
RA5749208	CPP 40 BX 5 mcr	40"	5	5000	1016	70	25
RA5749209	CPP 40 BX 10 mcr	40"	10	5000	1016	70	25
RA5749211	CPP 40 BX 25 mcr	40"	25	5000	1016	70	25
RA5749214	CPP 40 BX 50 mcr	40"	50	5000	1016	70	25

- 1 micron ———
- 5 micron ———
- 10 micron ———
- 25 micron ———
- 50 micron ———

**FLOW RATE vs PRESSURE DROP  $\Delta p$**

Tests carried on 10" elements type **CPP 10 SX**.  
 Testing mode: 20°C, 3 BAR

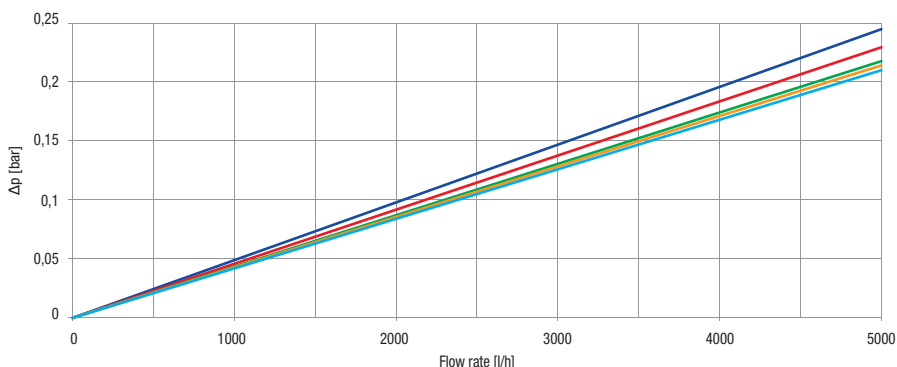

Some items in the list are subject to minimum order quantities and/or to longer delivery term.



# CPP BIG melt-blown polypropylene

**Sediment filtration.**  
**Average life-span:** 3-6 months.  
**Maintenance:** none.

**WORKING CONDITIONS**

Max working temperature \_\_\_\_\_ 80°C (176°F)  
 Min working temperature \_\_\_\_\_ 4°C (39.2°F)

**SPECIFICATIONS**

Non-toxic materials, suitable for drinking water.  
 Filter medium: polypropylene.

A range of 4.50" OD melt-blow polypropylene cartridges designed to fit to DP BIG housings and respond to the most effective heavy-duty sediment filtration requirements, suitable to industrial as well as domestic applications. Atlas Filtri CPP BIG melt-blown cartridges are made to comply with the most stringent regulations for applications in drinking water. Polypropylene is suitable to many industrial applications due to its wide chemical-physical compatibility to a variety of water-based solutions.

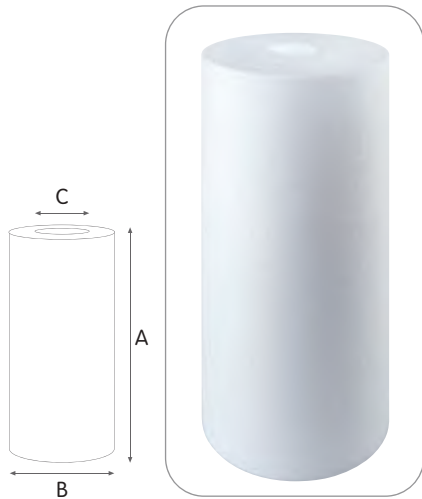

## CPP BIG SX

**POLYPROPYLENE MELT-BLOWN SMOOTH CARTRIDGES WITH DOUBLE OPEN END (DOE)**

CODE	MODEL	NOMINAL HEIGHT	NOMINAL FILTRATION MICRON	RECOMMENDED FLOW RATE l/h	DIMENSIONS MM		
					A	B	C
<b>OD 4,50" x ID 1,10"</b>							
RE5706606	CPP 10 BIG SX 1 mcr	10"	1	2500	250	112	28
RE5706608	CPP 10 BIG SX 5 mcr	10"	5	2500	250	112	28
RE5706611	CPP 10 BIG SX 25 mcr	10"	25	2500	250	112	28
RE5706906	CPP 20 BIG SX 1 mcr	20"	1	4000	511	112	28
RE5706908	CPP 20 BIG SX 5 mcr	20"	5	4000	511	112	28
RE5706911	CPP 20 BIG SX 25 mcr	20"	25	4000	511	112	28

CPP BIG cartridges are available in a variety of:

**CONFIGURATIONS:**

- SX standard configuration double open end (DOE) available for every height.

**MODELS:**

- CPP BIG series 10" and 20", OD 4.50", ID 1.10". SX configuration.

**CERTIFICATIONS**



CPP 10 BIG SX 5 mcr and CPP 20 BIG SX 5 mcr cartridges are certified by IAPMO RT to NSF/ANSI 42 - Material Safety Only, 61, 372 - lead free, CSA B483.1 - Material Safety Only. In compliance with Drinking Water Treatment Units regulations, USA and CANADA.



CPP BIG cartridges are tested and certified under the most stringent procedures worldwide, in compliance with DM 25 (Italy) and with the sanitary certification EAC/Ghostreghistrizia (Russia).

**FLOW RATE vs PRESSURE DROP Δp**

Tests carried on 10" elements type **CPP 10 BIG SX**.  
 Testing mode: 20°C, 3 BAR

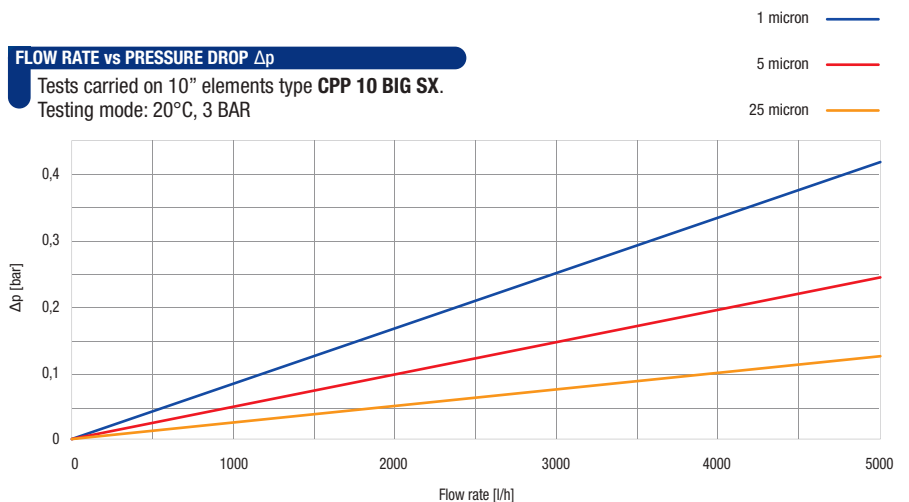



# PP melt-blown polypropylene

**Sediment filtration.**  
**Average life-span:** 3-6 months.  
**Maintenance:** none.

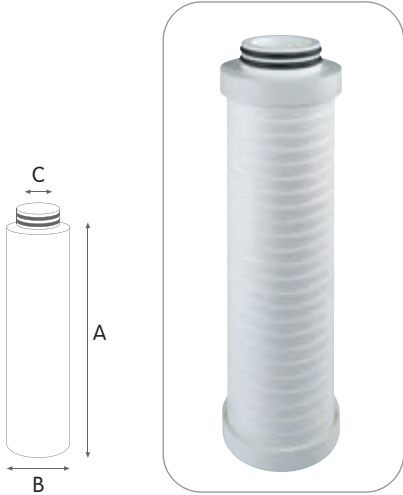
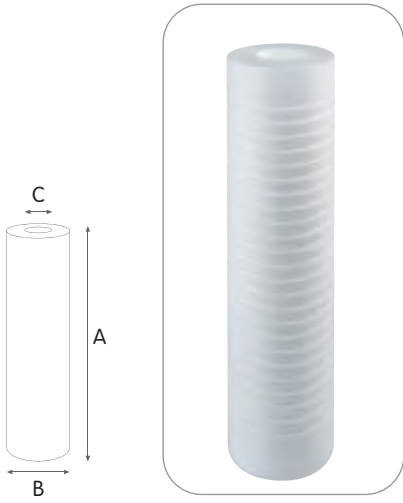

PP are available in a variety of:

**CONFIGURATIONS:**

- SX standard configuration double open end (DOE) available for every height and diameter.
- BX proprietary configuration with double o-ring collar 45 mm, suitable to PLUS 3P BX housings, DP housings, K DP housings.

Other end-caps configurations (code C8, C7, P8) available on demand by minimum quantity.

**MODELS:**

- PP series 10" and 20" OD 2.40" ID 1.10", SX, BX configurations, other end-caps configurations available on demand by minimum quantity.

**VARIANTS AVAILABLE ON MINIMUM QUANTITY:**

- PP CX with double o-ring collar 57 mm, suitable to PLUS 3P CX, K DP housings.

**CERTIFICATIONS**



PP cartridges are tested and certified under the most stringent procedures worldwide, in compliance with DM 25 (Italy), with the sanitary certification EAC/Ghostreghistrizia (Russia) and WaterMark (Australia).

**WORKING CONDITIONS**

Max working temperature \_\_\_\_\_ 80°C (176°F)  
 Min working temperature \_\_\_\_\_ 4°C (39,2°F)

**SPECIFICATIONS**

Non-toxic materials, suitable for drinking water.  
 Filter medium: polypropylene.  
 End caps BX: polypropylene.  
 O-rings BX: EPDM.

Atlas Filtri high efficiency melt-blown polypropylene cartridges are manufactured in specific plant which includes the standardization of production with dedicated software at every process' stage, thermal insulation at controlled temperature, full automation of the whole production line, from the raw-material loading to the finished product packing, without operator direct contact with the product, granting full hygienic safety. Certified raw materials, high productivity and quick delivery time, flexibility of production and custom made products complete the benefits of the range. PP grooved cartridges are available at heights 10" and 20" with end-caps in various configurations. PP cartridges are made to comply with the most stringent regulations for applications in drinking water. Polypropylene is suitable to many industrial applications due to its wide chemical-physical compatibility to a variety of water-based solutions.

**PP SX**

**POLYPROPYLENE MELT-BLOWN GROOVE CARTRIDGES WITH DOUBLE OPEN END (DOE)**

CODE	MODEL	NOMINAL HEIGHT	NOMINAL FILTRATION MICRON	RECOMMENDED FLOW RATE l/h	DIMENSIONS MM		
					A	B	C
<b>OD 2,40" x ID 1,10"</b>							
RA5706406	PP 10 SX 1 mcr	10"	1	2000	250	61	28
RA5706408	PP 10 SX 5 mcr	10"	5	2000	250	61	28
RA5706409	PP 10 SX 10 mcr	10"	10	2000	250	61	28
RA5706411	PP 10 SX 25 mcr	10"	25	2000	250	61	28
RA5706414	PP 10 SX 50 mcr	10"	50	2000	250	61	28
RA5707406	PP 20 SX 1 mcr	20"	1	3000	505	61	28
RA5707408	PP 20 SX 5 mcr	20"	5	3000	505	61	28
RA5707409	PP 20 SX 10 mcr	20"	10	3000	505	61	28
RA5707411	PP 20 SX 25 mcr	20"	25	3000	505	61	28
RA5707414	PP 20 SX 50 mcr	20"	50	3000	505	61	28

**PP BX**

**POLYPROPYLENE MELT-BLOWN GROOVE CARTRIDGES WITH DOUBLE O-RING COLLAR 45 MM**

CODE	MODEL	NOMINAL HEIGHT	NOMINAL FILTRATION MICRON	RECOMMENDED FLOW RATE l/h	DIMENSIONS MM		
					A	B	C
<b>OD 2,40" x ID 1,10"</b>							
RA5735206	PP 10 BX 1 mcr	10"	1	2000	250	70	25
RA5735208	PP 10 BX 5 mcr	10"	5	2000	250	70	25
RA5735209	PP 10 BX 10 mcr	10"	10	2000	250	70	25
RA5735211	PP 10 BX 25 mcr	10"	25	2000	250	70	25
RA5735214	PP 10 BX 50 mcr	10"	50	2000	250	70	25
RA5737206	PP 20 BX 1 mcr	20"	1	3000	505	70	25
RA5737208	PP 20 BX 5 mcr	20"	5	3000	505	70	25
RA5737209	PP 20 BX 10 mcr	20"	10	3000	505	70	25
RA5737211	PP 20 BX 25 mcr	20"	25	3000	505	70	25
RA5737214	PP 20 BX 50 mcr	20"	50	3000	505	70	25

- 1 micron —
- 5 micron —
- 10 micron —
- 25 micron —
- 50 micron —

**FLOW RATE vs PRESSURE DROP Δp**

Tests carried on 10" elements type **PP 10 SX**.  
 Testing mode: 20°C, 3 BAR

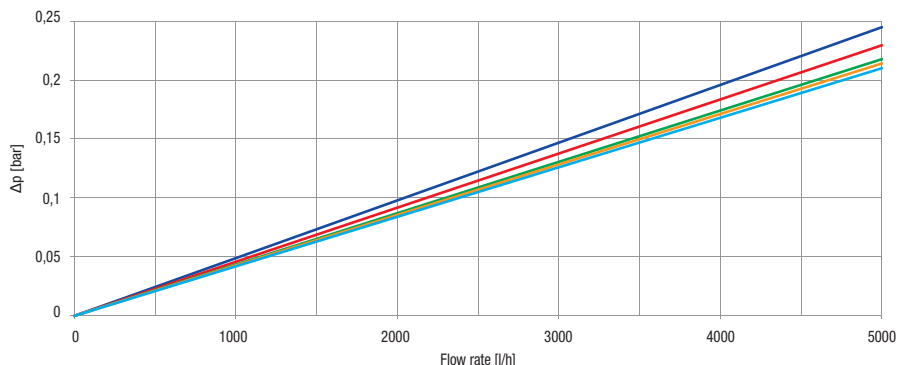

Some items in the list are subject to minimum order quantities and/or to longer delivery term.



# GA quartzite block

## Sediment filtration.

**Average life-span:** 3-6 months.

**Maintenance:** none.

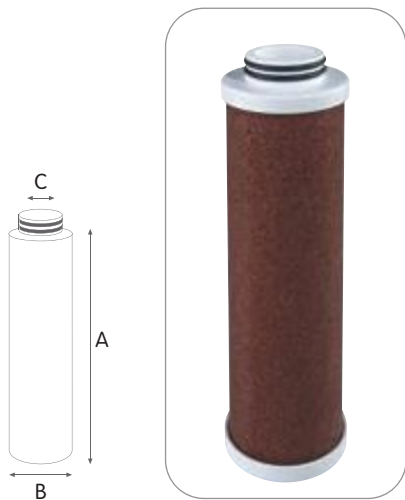
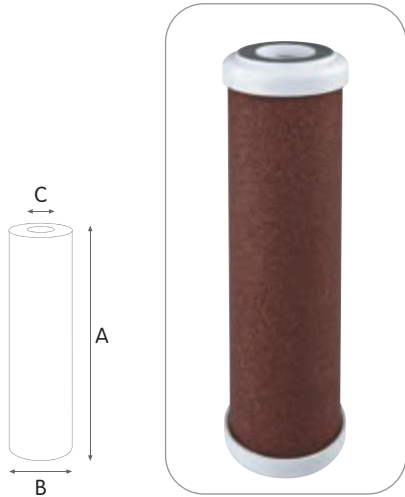

## WORKING CONDITIONS

Max working temperature \_\_\_\_\_ 45°C (113°F)  
Min working temperature \_\_\_\_\_ 4°C (39,2°F)

## SPECIFICATIONS

Non-toxic materials, suitable for drinking water.  
Filter medium: conglomerate of quartzite granules.  
End caps: polypropylene.  
Flat seals SX: SEBS with antimicrobial technology.  
O-rings BX: EPDM.

Quartzite cartridges providing fine filtration with consistent water flow, designed for water and beverage clarification, filtration at 10 micron. Height from 4" to 20".

## GA SX

### QUARTZITE BLOCK WITH DOUBLE OPEN END (DOE)

CODE	MODEL	NOMINAL HEIGHT	NOMINAL FILTRATION MICRON	RECOMMENDED FLOW RATE l/h	DIMENSIONS MM		
					A	B	C
<b>OD 2,40" x ID 1,10"</b>							
RA5101109	GA 4 SX 10 mcr	4"	10	500	101	70	30
RA5102109	GA 5 SX 10 mcr	5"	10	750	125	70	30
RA5104109	GA 7 SX 10 mcr	7"	10	1000	173	70	30
RA5105109	GA 10 SX 10 mcr	10"	10	1500	250	70	30
RA5107109	GA 20 SX 10 mcr	20"	10	2500	505	70	30

## GA BX

### QUARTZITE BLOCK WITH DOUBLE O-RING COLLAR 45 MM

CODE	MODEL	NOMINAL HEIGHT	NOMINAL FILTRATION MICRON	RECOMMENDED FLOW RATE l/h	DIMENSIONS MM		
					A	B	C
<b>OD 2,40" x ID 1,10"</b>							
RA5102209	GA 5 BX 10 mcr	5"	10	750	125	70	30
RA5104209	GA 7 BX 10 mcr	7"	10	1000	173	70	30
RA5105209	GA 10 BX 10 mcr	10"	10	1500	250	70	30
RA5107209	GA 20 BX 10 mcr	20"	10	2500	505	70	30

GA cartridges are available in a variety of:

## CONFIGURATIONS:

- SX standard configuration double open end (DOE) available for every height and diameter.
- BX proprietary configuration with double o-ring collar 45 mm, suitable to PLUS 3P BX housings, DP housings, K DP housings.

## MODELS:

- GA series from 4" to 20" OD 2.40" ID 1.10", SX, BX configurations.

## CERTIFICATIONS



GA cartridges are tested and certified under the most stringent procedures worldwide, **in compliance with DM 25 (Italy), with the sanitary certification EAC/Ghostreghistracia (Russia) and WaterMark (Australia).**

## FLOW RATE vs PRESSURE DROP $\Delta p$

Tests carried on 10" elements type **GA 10 SX**.  
Testing mode: 20°C, 3 BAR

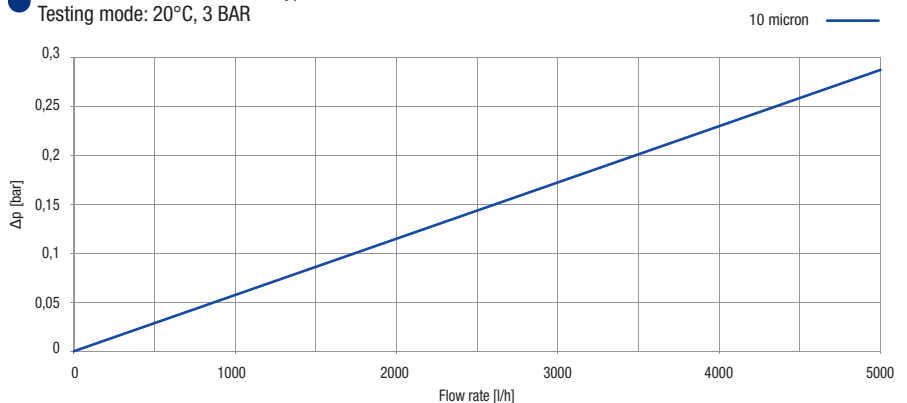



# TS pleated polyester fabric

**Sediment filtration.**  
**Average life-span:** 6-12 months.  
**Maintenance:** none.

## WORKING CONDITIONS

Max working temperature \_\_\_\_\_ 45°C (113°F)  
 Min working temperature \_\_\_\_\_ 4°C (39,2°F)

## SPECIFICATIONS

Non-toxic materials, suitable for drinking water.  
 Filter medium: polyester fabric.  
 Inner core and end caps: polypropylene.  
 Flat seals SX: SEBS with antimicrobial technology.  
 O-rings BX and CX: EPDM.

Washable cartridges made of pleated fabric with large filtering surface, long service time, high water flow and low pressure drop, filtration at 50 micron. Height from 4" to 20".

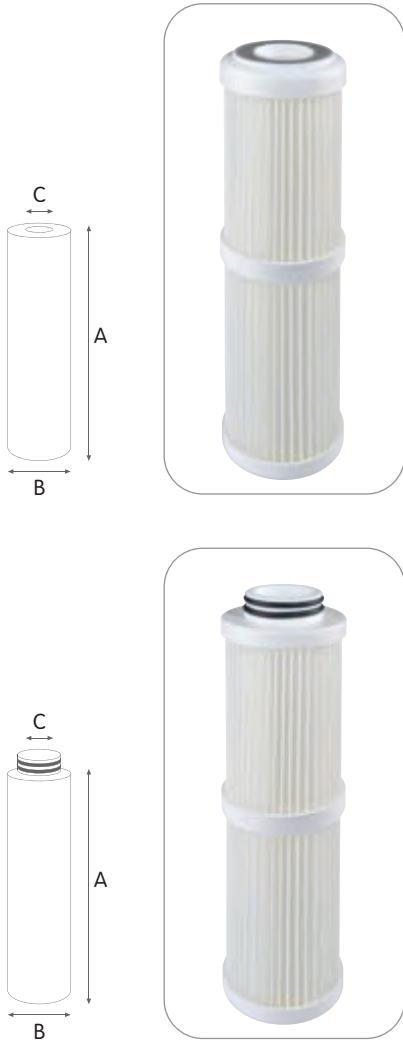

## TS SX

### PLEATED POLYESTER FABRIC WITH DOUBLE OPEN END (DOE)

CODE	MODEL	NOMINAL HEIGHT	NOMINAL FILTRATION MICRON	RECOMMENDED FLOW RATE l/h	DIMENSIONS MM		
					A	B	C
<b>OD 1,77" x ID 0,71"</b>							
RA5040114	TS MIGNON SX 50 mcr	5" M	50	800	122	50	20
<b>OD 2,40" x ID 1,10"</b>							
RA5041114	TS 4 SX 50 mcr	4"	50	1000	101	70	30
RA5042114	TS 5 SX 50 mcr	5"	50	1200	125	70	30
RA5044114	TS 7 SX 50 mcr	7"	50	1700	173	70	30
RA5045114	TS 10 SX 50 mcr	10"	50	2500	250	70	30
RA5047114	TS 20 SX 50 mcr	20"	50	4000	505	70	30

## TS BX

### PLEATED POLYESTER FABRIC WITH DOUBLE O-RING COLLAR 45 MM

CODE	MODEL	NOMINAL HEIGHT	NOMINAL FILTRATION MICRON	RECOMMENDED FLOW RATE l/h	DIMENSIONS MM		
					A	B	C
<b>OD 2,40" x ID 1,10"</b>							
RA5042214	TS 5 BX 50 mcr	5"	50	1200	125	70	30
RA5044214	TS 7 BX 50 mcr	7"	50	1700	173	70	30
RA5045214	TS 10 BX 50 mcr	10"	50	2500	250	70	30
RA5047214	TS 20 BX 50 mcr	20"	50	4000	505	70	30

## TS CX

### PLEATED POLYESTER FABRIC WITH DOUBLE O-RING COLLAR 57 MM

CODE	MODEL	NOMINAL HEIGHT	NOMINAL FILTRATION MICRON	RECOMMENDED FLOW RATE l/h	DIMENSIONS MM		
					A	B	C
<b>OD 2,40" x ID 1,10"</b>							
RA5045314	TS 10 CX 50 mcr	10"	50	2500	250	70	40
RA5047314	TS 20 CX 50 mcr	20"	50	4000	505	70	40

TS cartridges are available in a variety of:

### CONFIGURATIONS:

- SX standard configuration double open end (DOE) available for every height and diameter.
- BX proprietary configuration with double o-ring collar 45 mm, suitable to PLUS 3P BX housings, DP housings, K DP housings.
- CX proprietary configuration with double o-ring collar 57 mm, suitable to PLUS 3P CX, K DP housings.

### MODELS:

- TS MIGNON series 5" M OD 1.77" ID 0.71, SX configuration.
- TS series from 4" to 20" OD 2.40" ID 1.10", SX, BX, CX configurations.

### CERTIFICATIONS



TS cartridges are tested and certified under the most stringent procedures worldwide, in compliance with DM 25 (Italy), with the sanitary certification EAC/Ghostreghistracia (Russia) and WaterMark (Australia).

### FLOW RATE vs PRESSURE DROP Δp

Tests carried on 10" elements type **TS 10 SX**.  
 Testing mode: 20°C, 3 BAR

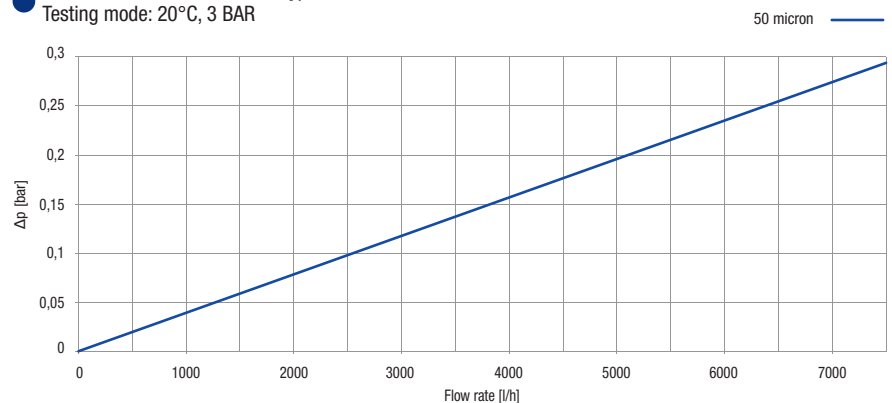



# TS BIG pleated polyester fabric

**Sediment filtration.**  
**Average life-span:** 6-12 months.  
**Maintenance:** none.

## WORKING CONDITIONS

Max working temperature \_\_\_\_\_ 45°C (113°F)  
 Min working temperature \_\_\_\_\_ 4°C (39,2°F)

## SPECIFICATIONS

Non-toxic materials, suitable for drinking water.  
 Filter medium: polyester fabric.  
 Inner core and end caps: polypropylene.  
 Flat seals: SEBS with antimicrobial technology.

Range of washable cartridges with 4,50" outer diameter, made of pleated fabric with very large filtering surface, providing longer service time, high water flow and low pressure drop, filtration at 50 micron. Heights 10" and 20".

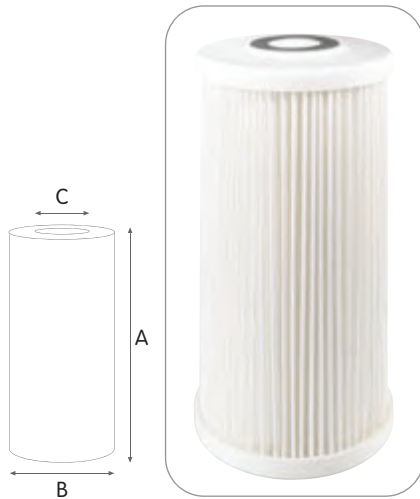

## TS BIG

### PLEATED POLYESTER FABRIC WITH DOUBLE OPEN END (DOE)

CODE	MODEL	NOMINAL HEIGHT	NOMINAL FILTRATION MICRON	RECOMMENDED FLOW RATE l/h	DIMENSIONS MM		
					A	B	C
<b>OD 4,50" x ID 1,10"</b>							
RA5045514	TS 10 BIG SX 50 mcr	10"	50	3500	250	118	27
RA5047514	TS 20 BIG SX 50 mcr	20"	50	5000	508	118	27

TS BIG cartridges are available in a variety of:

### CONFIGURATIONS:

- SX standard configuration double open end (DOE) available for every height and diameter.

### MODELS:

- TS BIG series 10" and 20", OD 4.50", ID 1.10". SX configuration.

### CERTIFICATIONS



TS BIG cartridges are tested and certified under the most stringent procedures worldwide, in compliance with DM 25 (Italy) and with the sanitary certification EAC/Ghostreghistrizia (Russia).

### Surface Area:

1,31 m<sup>2</sup> (14.10 ft<sup>2</sup>) for 10" models; 2,82 m<sup>2</sup> (30.35 ft<sup>2</sup>) for 20" models

### FLOW RATE vs PRESSURE DROP $\Delta p$

Tests carried on 10" elements type **TS 10 BIG**.  
 Testing mode: 20°C, 3 BAR

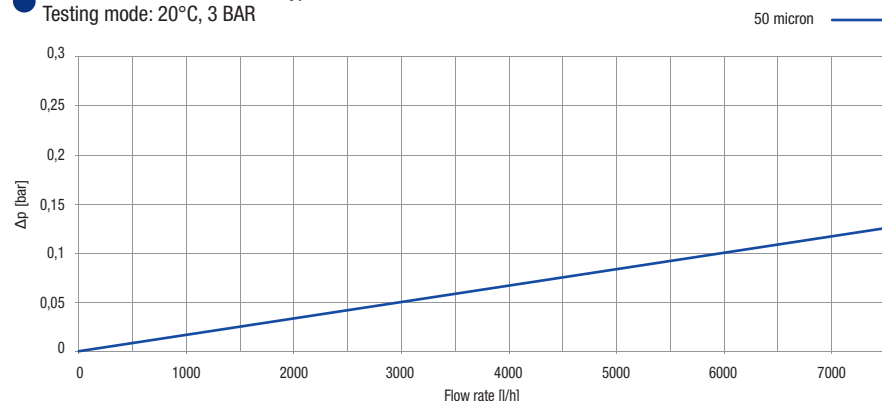





# CS pleated special paper

**Sediment filtration.**  
**Average life-span:** 3-6 months.  
**Maintenance:** none.

## WORKING CONDITIONS

Max working temperature \_\_\_\_\_ 45°C (113°F)  
 Min working temperature \_\_\_\_\_ 4°C (39,2°F)

## SPECIFICATIONS

Filter medium: special paper.  
 Inner core and end caps: polypropylene.  
 Flat seals SX: SEBS with antimicrobial technology.  
 O-rings BX and CX: EPDM.

Cartridges made of special pleated paper with large filtering surface, providing long service time, high water flow and low pressure drop, filtration at 25 micron. Height from 4" to 20".

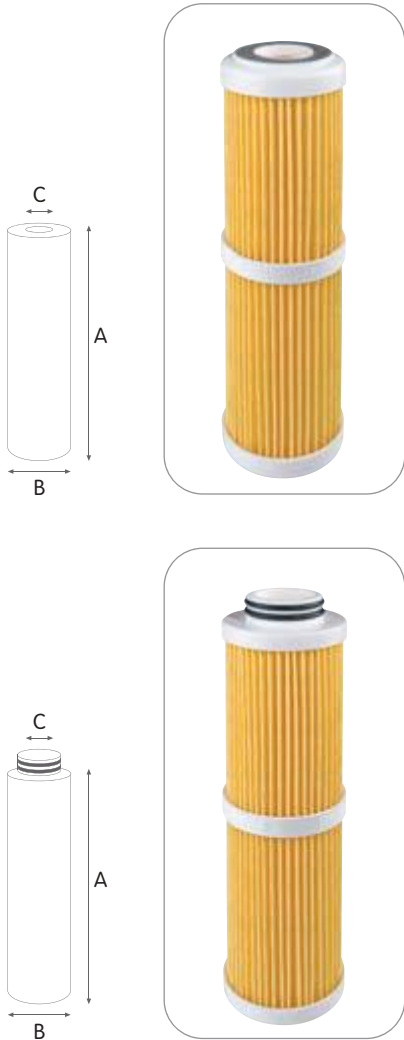

## CS SX

### PLEATED SPECIAL PAPER WITH DOUBLE OPEN END (DOE)

CODE	MODEL	NOMINAL HEIGHT	NOMINAL FILTRATION MICRON	RECOMMENDED FLOW RATE l/h	DIMENSIONS MM		
					A	B	C
<b>OD 1,77" x ID 0,71"</b>							
RA5030111	CS MIGNON SX 25 mcr	5" M	25	800	122	50	20
<b>OD 2,40" x ID 1,10"</b>							
RA5031111	CS 4 SX 25 mcr	4"	25	1000	101	70	30
RA5032111	CS 5 SX 25 mcr	5"	25	1200	125	70	30
RA5034111	CS 7 SX 25 mcr	7"	25	1700	173	70	30
RA5035111	CS 10 SX 25 mcr	10"	25	2500	250	70	30
RA5037111	CS 20 SX 25 mcr	20"	25	4000	505	70	30

## CS BX

### PLEATED SPECIAL PAPER WITH DOUBLE O-RING COLLAR 45 MM

CODE	MODEL	NOMINAL HEIGHT	NOMINAL FILTRATION MICRON	RECOMMENDED FLOW RATE l/h	DIMENSIONS MM		
					A	B	C
<b>OD 2,40" x ID 1,10"</b>							
RA5032211	CS 5 BX 25 mcr	5"	25	1200	125	70	30
RA5034211	CS 7 BX 25 mcr	7"	25	1700	173	70	30
RA5035211	CS 10 BX 25 mcr	10"	25	2500	250	70	30
RA5037211	CS 20 BX 25 mcr	20"	25	4000	505	70	30

## CS CX

### PLEATED SPECIAL PAPER WITH DOUBLE O-RING COLLAR 57 MM

CODE	MODEL	NOMINAL HEIGHT	NOMINAL FILTRATION MICRON	RECOMMENDED FLOW RATE l/h	DIMENSIONS MM		
					A	B	C
<b>OD 2,40" x ID 1,10"</b>							
RA5035311	CS 10 CX 25 mcr	10"	25	2500	250	70	40
RA5037311	CS 20 CX 25 mcr	20"	25	4000	505	70	40

CS cartridges are available in a variety of:

### CONFIGURATIONS:

- SX standard configuration double open end (DOE) available for every height and diameter.
- BX proprietary configuration with double o-ring collar 45 mm, suitable to PLUS 3P BX housings, DP housings, K DP housings.
- CX proprietary configuration with double o-ring collar 57 mm, suitable to PLUS 3P CX, K DP housings.

### MODELS:

- CS MIGNON series 5" M OD 1.77" ID 0.71, SX configuration.
- CS series from 4" to 20" OD 2.40" ID 1.10", SX, BX, CX configurations.

### CERTIFICATIONS



CS cartridges are tested and certified under the most stringent procedures worldwide, in compliance with DM 25 (Italy), with the sanitary certification EAC/Ghostreghistracia (Russia) and WaterMark (Australia).

### FLOW RATE vs PRESSURE DROP $\Delta p$

Tests carried on 10" elements type **CS 10 SX**.  
 Testing mode: 20°C, 3 BAR

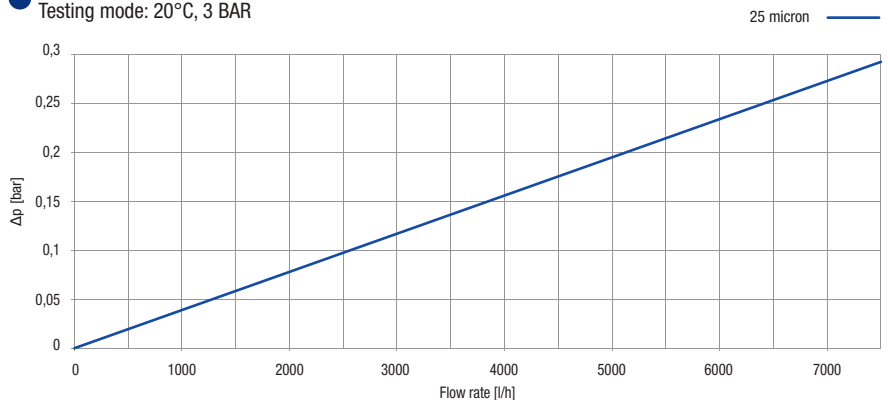



# CS BIG pleated special paper

**Sediment filtration.**  
**Average life-span:** 3-6 months.  
**Maintenance:** none.

## WORKING CONDITIONS

Max working temperature \_\_\_\_\_ 45°C (113°F)  
 Min working temperature \_\_\_\_\_ 4°C (39,2°F)

## SPECIFICATIONS

Filter medium: special paper.  
 Inner core and end caps: polypropylene.  
 Flat seals: SEBS with antimicrobial technology.

Range of cartridges with 4,50" outer diameter, made of pleated paper with very large filtering surface, providing longer service time, high water flow and low pressure drop, filtration at 25 micron. Height 10" and 20".

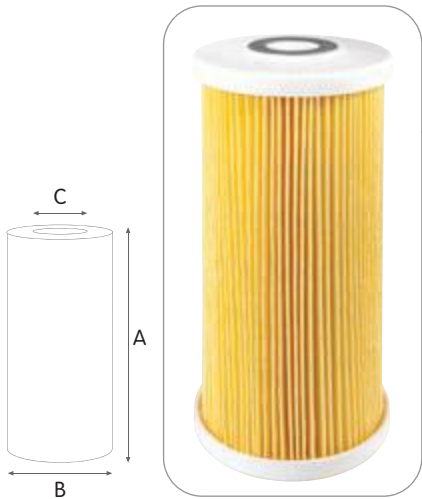

## CS BIG

### PLEATED SPECIAL PAPER WITH DOUBLE OPEN END (DOE)

CODE	MODEL	NOMINAL HEIGHT	NOMINAL FILTRATION MICRON	RECOMMENDED FLOW RATE l/h	DIMENSIONS MM		
					A	B	C
<b>OD 4,50" x ID 1,10"</b>							
RA5035511	CS 10 BIG SX 25 mcr	10"	25	2500	250	118	27
RA5037511	CS 20 BIG SX 25 mcr	20"	25	4000	508	118	27

CS BIG cartridges are available in a variety of:

### CONFIGURATIONS:

- SX standard configuration double open end (DOE) available for every height and diameter.

### MODELS:

- CS BIG series 10" and 20", OD 4.50", ID 1.10". SX configuration.

### CERTIFICATIONS



CS BIG cartridges are tested and certified under the most stringent procedures worldwide, in compliance with DM 25 (Italy) and with the sanitary certification EAC/Ghostreghistrizia (Russia).

### Surface Area:

1,31 m<sup>2</sup> (14.10 ft<sup>2</sup>) for 10" models; 2,82 m<sup>2</sup> (30.35 ft<sup>2</sup>) for 20" models

### FLOW RATE vs PRESSURE DROP Δp

Tests carried on 10" elements type **CS 10 BIG**.  
 Testing mode: 20°C, 3 BAR

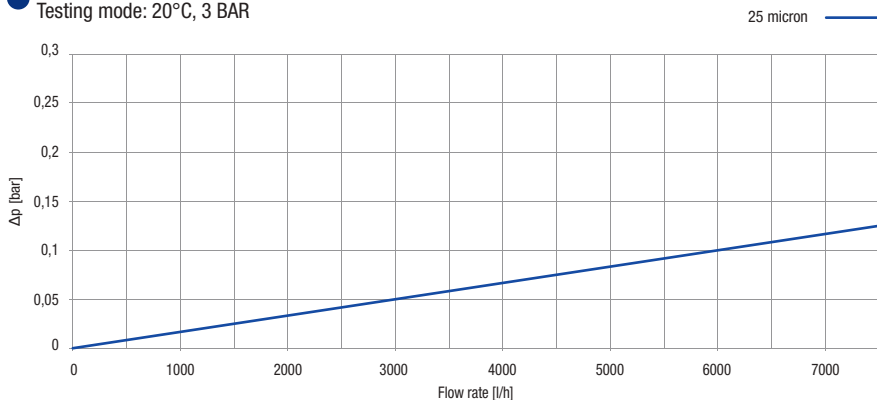



# AB ceramic

**Fine sediment filtration.**

**Average life-span:** 6-12 months.

**Maintenance:** surface scraping every 2-3 months.

**Remark** - Use a pre-filter to protect the cartridge.

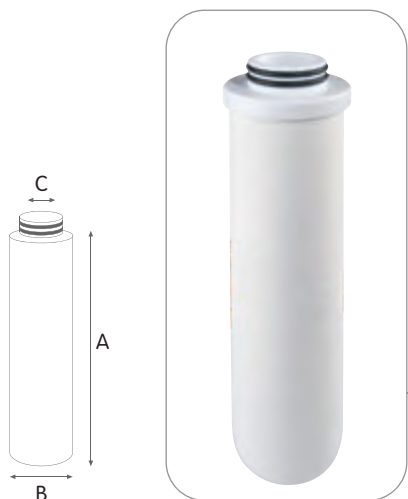
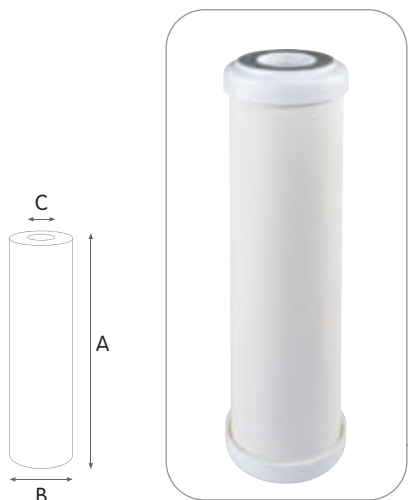

**WORKING CONDITIONS**

Max working temperature \_\_\_\_\_ 45°C (113°F)  
 Min working temperature \_\_\_\_\_ 4°C (39,2°F)

**SPECIFICATIONS**

Non-toxic materials, suitable for drinking water.  
 Filter medium: ceramic, self-supporting frame.  
 End caps: polypropylene.  
 Flat seals SX: SEBS with antimicrobial technology.  
 O-rings BX: EPDM.

Cartridges made with ceramic filtering medium providing very fine filtration with good water flow, designed for water clarification, filtration at 0.45 micron. Height from 4" to 20".

**AB SX**

**CERAMIC WITH DOUBLE OPEN END (DOE)**

CODE	MODEL	NOMINAL HEIGHT	NOMINAL FILTRATION MICRON	RECOMMENDED FLOW RATE I/h	DIMENSIONS MM		
					A	B	C
<b>OD 1,77" x ID 0,71"</b>							
RA5260102	AB MIGNON SX 0,45 mcr	5" M	0,45	80	122	50	20
RE5155102	AB 10 V SX 0,45 mcr	10"	0,45	200	250	50	20
<b>OD 2,40" x ID 1,10"</b>							
RA5261102	AB 4 SX 0,45 mcr	4"	0,45	120	101	70	30
RA5262102	AB 5 SX 0,45 mcr	5"	0,45	150	125	70	30
RA5264102	AB 7 SX 0,45 mcr	7"	0,45	200	173	70	30
RA5265102	AB 10 SX 0,45 mcr	10"	0,45	300	250	70	30
RA5267102	AB 20 SX 0,45 mcr	20"	0,45	500	505	70	30

**AB BX**

**CERAMIC WITH DOUBLE O-RING COLLAR 45 MM**

CODE	MODEL	NOMINAL HEIGHT	NOMINAL FILTRATION MICRON	RECOMMENDED FLOW RATE I/h	DIMENSIONS MM		
					A	B	C
<b>OD 2,40" x ID 1,10"</b>							
RA5262202	AB 5 BX 0,45 mcr	5"	0,45	150	125	70	30
RA5264202	AB 7 BX 0,45 mcr	7"	0,45	200	173	70	30
RA5265202	AB 10 BX 0,45 mcr	10"	0,45	300	250	70	30
RA5267202	AB 20 BX 0,45 mcr	20"	0,45	500	505	70	30

AB cartridges are available in a variety of:

**CONFIGURATIONS:**

- SX standard configuration double open end (DOE) available for every height and diameter.
- BX proprietary configuration with double o-ring collar 45 mm, suitable to PLUS 3P BX housings, DP housings, K DP housings.

**MODELS:**

- AB MIGNON series 5"M OD 1.77" ID 0.71, SX configuration.
- AB-V series 10" OD 1.77" ID 0.71, SX configuration.
- AB series from 4" to 40" OD 2.40" ID 1.10", SX, BX configurations.

**CERTIFICATIONS**



AB cartridges are tested and certified under the most stringent procedures worldwide, in compliance with DM 25 (Italy), with the sanitary certification EAC/Ghostreghistracia (Russia) and WaterMark (Australia).

**FLOW RATE vs PRESSURE DROP Δp**

Tests carried on 10" elements type **AB 10 SX**.  
 Testing mode: 20°C, 3 BAR

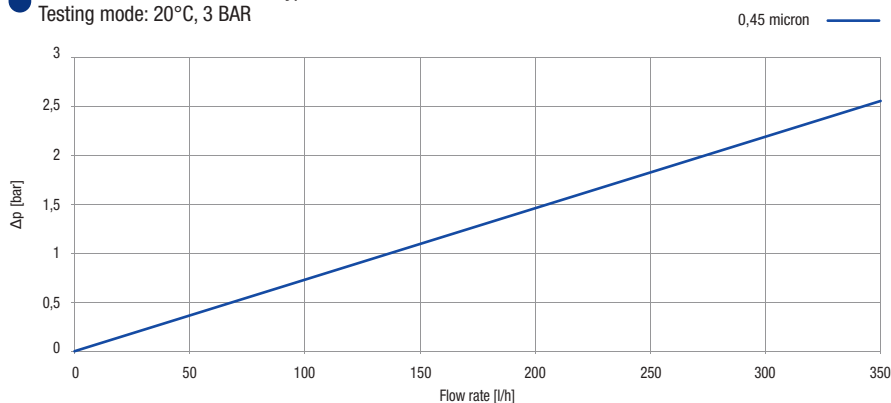



# AC pleated polypropylene-borosilicate

## Fine sediment filtration

**Average life-span:** 3-6 months.

**Maintenance:** none.

**Remark -** Use a pre-filter to protect the cartridge.

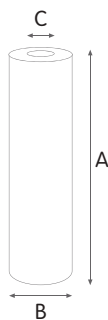

AC cartridges are available in a variety of:

### CONFIGURATIONS:

- SX standard configuration double open end (DOE) available for every height and diameter.
- BX proprietary configuration with double o-ring collar 45 mm, suitable to PLUS 3P BX housings, DP housings, K DP housings.

### MODELS:

- AC series 10" and 20" OD 2.40" ID 1.10", SX, BX configurations.

### VARIANTS AVAILABLE

#### ON MINIMUM QUANTITY:

- AC series with height 30", 40"
- AC-K series with polypropylene-borosilicate, polypropylene or polyester filter medium; polypropylene moulded armouring, inner core, end-caps; height 10", 20", 30", 40"; filter rates from 0.2 to 55 micron; SX, BX, P8, P7, C7 configurations.

### CERTIFICATIONS



AC cartridges are tested and certified under the most stringent procedures worldwide, in compliance with DM 25 (Italy), with the sanitary certification EAC/Ghostreghistracia (Russia) and WaterMark (Australia).

## WORKING CONDITIONS

Max working temperature \_\_\_\_\_ 85°C (185°F)  
 Min working temperature \_\_\_\_\_ 4°C (39,2°F)

## SPECIFICATIONS

Non-toxic materials, suitable for drinking water.  
 Filter medium: polypropylene-borosilicate.  
 Inner core and end caps: polypropylene.  
 Flat seals SX: BUNA®.  
 O-rings BX: EPDM.

Cartridges made of pleated polypropylene-borosilicate dual layer filter medium with extruded polypropylene outer cage, designed for fine and very fine particle filtration, with large filtering surface providing long service time, high water flow and low pressure drop, filtration at 0.45 and 0.2 micron. Height 10" and 20".

## AC SX

### PLEATED POLYPROPYLENE BOROSILICATE WITH DOUBLE OPEN END (DOE)

CODE	MODEL	NOMINAL HEIGHT	NOMINAL FILTRATION MICRON	RECOMMENDED FLOW RATE l/h	DIMENSIONS MM		
					A	B	C
<b>OD 2,40" x ID 1,10"</b>							
RE5165101	AC 10 SX BS 0,2 mcr	10"	0,2	1000	250	70	30
RE5165102	AC 10 SX BS 0,45 mcr	10"	0,45	1000	250	70	30
RE5167101	AC 20 SX BS 0,2 mcr	20"	0,2	1800	505	70	30
RE5167102	AC 20 SX BS 0,45 mcr	20"	0,45	1800	505	70	30

## AC BX

### PLEATED POLYPROPYLENE BOROSILICATE WITH DOUBLE O-RING COLLAR 45 MM

CODE	MODEL	NOMINAL HEIGHT	NOMINAL FILTRATION MICRON	RECOMMENDED FLOW RATE l/h	DIMENSIONS MM		
					A	B	C
<b>OD 2,40" x ID 1,10"</b>							
RE5165201	AC 10 BX BS 0,2 mcr	10"	0,2	1000	250	70	25
RE5165202	AC 10 BX BS 0,45 mcr	10"	0,45	1000	250	70	25
RE5167201	AC 20 BX BS 0,2 mcr	20"	0,2	1800	505	70	25
RE5167202	AC 20 BX BS 0,45 mcr	20"	0,45	1800	505	70	25

### FLOW RATE vs PRESSURE DROP Δp

Tests carried on 10" elements type **AC 10 SX 0,45 mcr**.  
 Testing mode: 20°C, 3 BAR

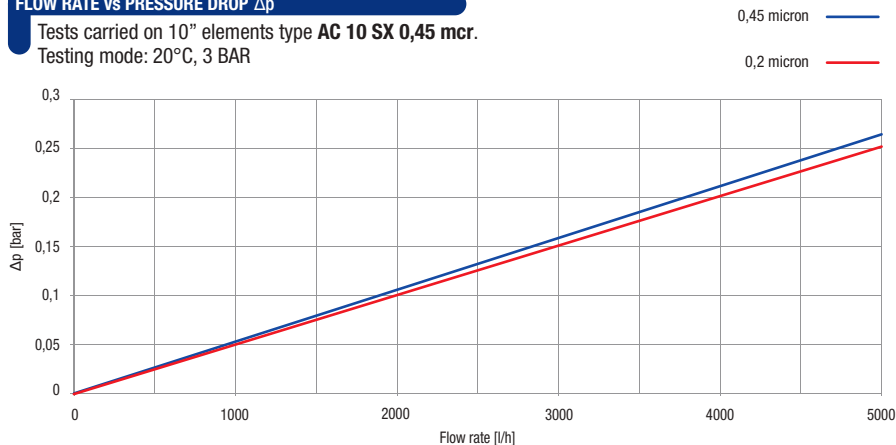



# RL polyester washable net

**Sediment filtration.**  
**Average life-span:** up to 24 months.  
**Maintenance:** wash every month at least.

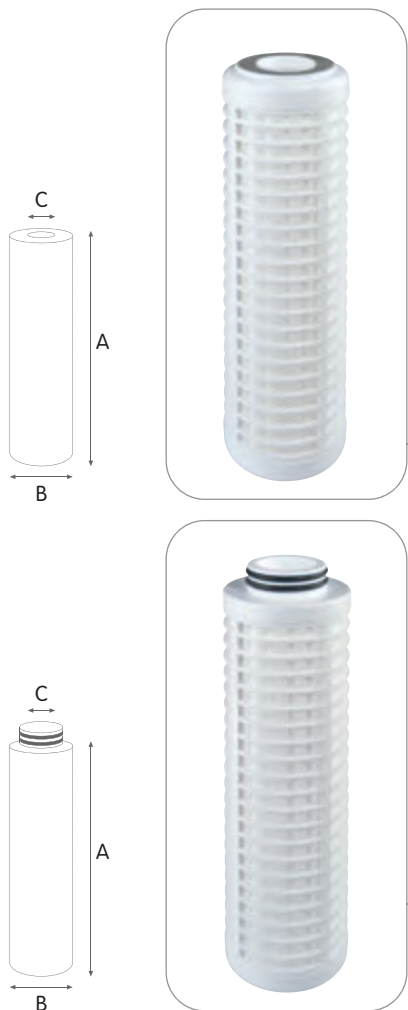

RL are available in a variety of:

**CONFIGURATIONS:**

- SX standard configuration double open end (DOE) available for every height and diameter.
- BX proprietary configuration with double o-ring collar 45 mm, suitable to PLUS 3P BX housings, DP housings, K DP housings.
- CX proprietary configuration with double o-ring collar 57 mm, suitable to PLUS 3P CX, K DP housings.

**MODELS:**

- RL MIGNON series 5”M OD 1.77” ID 0.71, SX configuration.
- RL series from 4” to 40” OD 2.40” ID 1.10”, SX, BX, CX configurations.

**VARIANTS AVAILABLE ON MINIMUM QUANTITY:**

- RL SX series at 30” and 40”.

**CERTIFICATIONS**



RL cartridges are tested and certified under the most stringent procedures worldwide, in compliance with DM 25 (Italy), with the sanitary certification ACS (France), EAC/Ghostregistrazia (Russia) and WaterMark (Australia).

**WORKING CONDITIONS**

Max working temperature \_\_\_\_\_ 45°C (113°F)  
 Min working temperature \_\_\_\_\_ 4°C (39,2°F)

**SPECIFICATIONS**

Non-toxic materials, suitable for drinking water.  
 Filter medium: polyester net.  
 Armouring and end caps: polypropylene.  
 Flat seals SX: SEBS with antimicrobial technology.  
 O-rings BX and CX: EPDM.

Washable net cartridges with consistent water flow and very low pressure drop, filtration at 50 micron. The cartridges are manufactured without glue and sealants, nets are included while molding the structural frame (armouring). Cartridges with structural frame designed for high resistance and duration, with height from 4” to 40”.

**RL SX**

**POLYESTER WASHABLE NET WITH DOUBLE OPEN END (DOE)**

CODE	MODEL	NOMINAL HEIGHT	NOMINAL FILTRATION MICRON	RECOMMENDED FLOW RATE l/h	DIMENSIONS MM		
					A	B	C
<b>OD 1,77” x ID 0,71”</b>							
RA5010114	RL MIGNON SX 50 mcr	5” M	50	800	122	50	20
<b>OD 2,40” x ID 1,10”</b>							
RA5011114	RL 4 SX 50 mcr	4”	50	1000	101	70	30
RA5012114	RL 5 SX 50 mcr	5”	50	1200	125	70	30
RA5014114	RL 7 SX 50 mcr	7”	50	1700	173	70	30
RA5015114	RL 10 SX 50 mcr	10”	50	2500	250	70	30
RA5017114	RL 20 SX 50 mcr	20”	50	4000	505	70	30

**RL BX**

**POLYESTER WASHABLE NET WITH DOUBLE O-RING COLLAR 45 MM**

CODE	MODEL	NOMINAL HEIGHT	NOMINAL FILTRATION MICRON	RECOMMENDED FLOW RATE l/h	DIMENSIONS MM		
					A	B	C
<b>OD 2,40” x ID 1,10”</b>							
RA5012214	RL 5 BX 50 mcr	5”	50	1200	125	70	30
RA5014214	RL 7 BX 50 mcr	7”	50	1700	173	70	30
RA5015214	RL 10 BX 50 mcr	10”	50	2500	250	70	30
RA5017214	RL 20 BX 50 mcr	20”	50	4000	505	70	30

**RL CX**

**POLYESTER WASHABLE NET WITH DOUBLE O-RING COLLAR 57 MM**

CODE	MODEL	NOMINAL HEIGHT	NOMINAL FILTRATION MICRON	RECOMMENDED FLOW RATE l/h	DIMENSIONS MM		
					A	B	C
<b>OD 2,40” x ID 1,10”</b>							
RA5015314	RL 10 CX 50 mcr	10”	50	2500	250	70	40
RA5017314	RL 20 CX 50 mcr	20”	50	4000	505	70	40

**FLOW RATE vs PRESSURE DROP Δp**

Tests carried on 10” elements type **RL 10 SX**.  
 Testing mode: 20°C, 3 BAR

50 micron

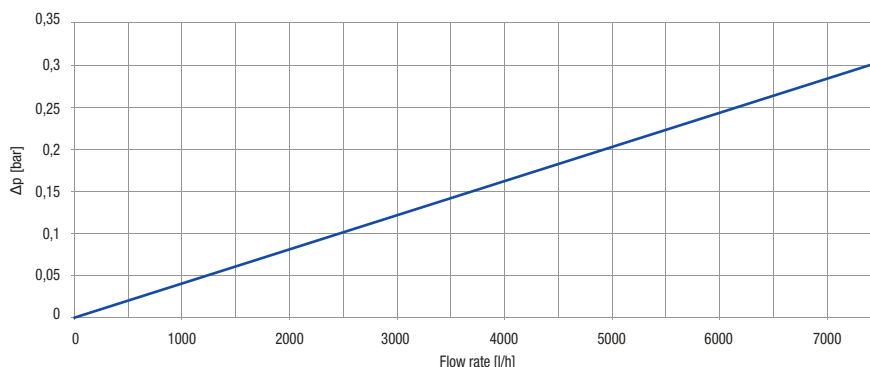



# RL C polyester washable net

**Average life-span:** up to 24 months.  
**Maintenance:** wash every month at least.

## WORKING CONDITIONS

Max working temperature \_\_\_\_\_ 45°C (113°F)  
 Min working temperature \_\_\_\_\_ 4°C (39,2°F)

## SPECIFICATIONS

Non-toxic materials, suitable for drinking water.  
 Filter medium: polyester net.  
 Armouring and end caps: polypropylene.  
 Flat seals SX: SEBS with antimicrobial technology.  
 O-rings BX and CX: EPDM.

Washable net cartridges with consistent water flow and very low pressure drop, filtration at 50 micron. The cartridges are manufactured without glue and sealants, nets are included while molding the structural frame (armouring), designed to provide easier cleaning of the surface, with height 10" and 20".

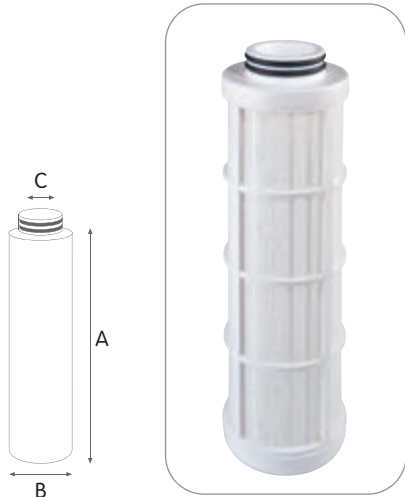
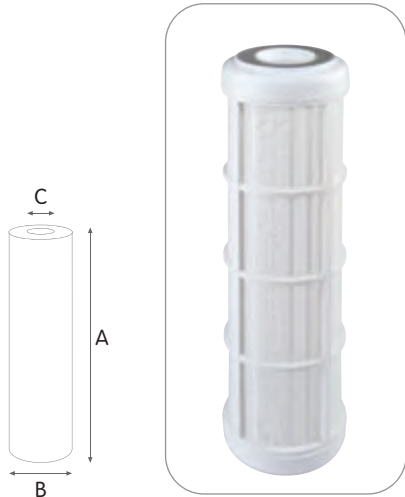

## RL C SX

### POLYESTER WASHABLE NET WITH DOUBLE OPEN END (DOE)

CODE	MODEL	NOMINAL HEIGHT	NOMINAL FILTRATION MICRON	RECOMMENDED FLOW RATE l/h	DIMENSIONS MM		
		A	B	C			
<b>OD 2,40" x ID 1,10"</b>							
RA5018114	RL C 10 SX 50 mcr	10"	50	2500	250	70	30
RA5020114	RL C 20 SX 50 mcr	20"	50	4000	505	70	30

## RL C BX

### POLYESTER WASHABLE NET WITH DOUBLE O-RING COLLAR 45 MM

CODE	MODEL	NOMINAL HEIGHT	NOMINAL FILTRATION MICRON	RECOMMENDED FLOW RATE l/h	DIMENSIONS MM		
		A	B	C			
<b>OD 2,40" x ID 1,10"</b>							
RA5018214	RL C 10 BX 50 mcr	10"	50	2500	250	70	30
RA5020214	RL C 20 BX 50 mcr	20"	50	4000	505	70	30

## RL C CX

### POLYESTER WASHABLE NET WITH DOUBLE O-RING COLLAR 57 MM

CODE	MODEL	NOMINAL HEIGHT	NOMINAL FILTRATION MICRON	RECOMMENDED FLOW RATE l/h	DIMENSIONS MM		
		A	B	C			
<b>OD 2,40" x ID 1,10"</b>							
RA5018314	RL C 10 CX 50 mcr	10"	50	2500	250	70	40
RA5020314	RL C 20 CX 50 mcr	20"	50	4000	505	70	40

RL C are available in a variety of:

### CONFIGURATIONS:

- SX standard configuration double open end (DOE) available for every height and diameter.
- BX proprietary configuration with double o-ring collar 45 mm, suitable to PLUS 3P BX housings, DP housings, K DP housings.
- CX proprietary configuration with double o-ring collar 57 mm, suitable to PLUS 3P CX, K DP housings.

### MODELS:

- RL-C series 10" and 20" OD 2.40" ID 1.10", SX, BX, CX configurations.

### CERTIFICATIONS



RL C cartridges are tested and certified under the most stringent procedures worldwide, in compliance with DM 25 (Italy), with the sanitary certification EAC/Ghostreghistrizia (Russia) and WaterMark (Australia).

### FLOW RATE vs PRESSURE DROP $\Delta p$

Tests carried on 10" elements type **RL C 10 SX**.  
 Testing mode: 20°C, 3 BAR

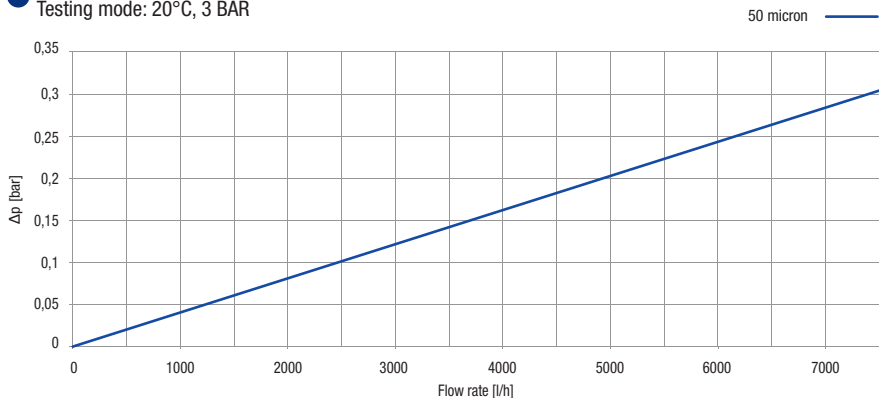





# RL A stainless steel washable net AISI 316

**Sediment filtration.**  
**Average life-span:** 2 - 3 years.  
**Maintenance:** wash every month at least.

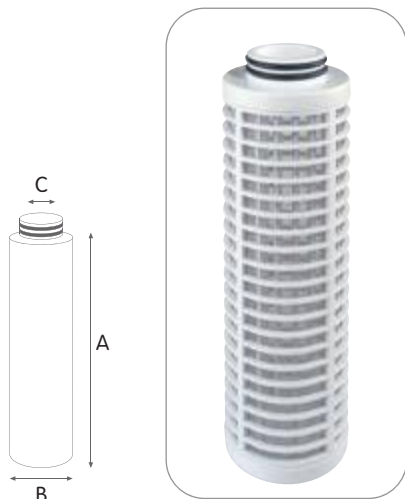
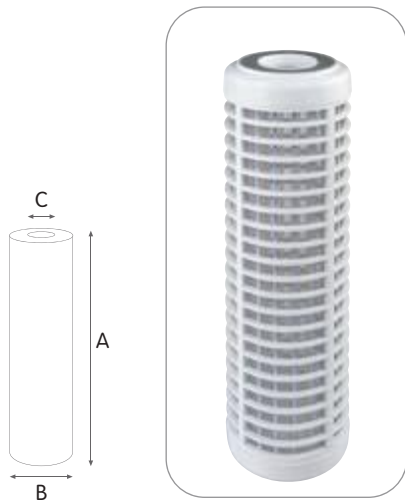

RL A are available in a variety of:

**CONFIGURATIONS:**

- SX standard configuration double open end (DOE) available for every height and diameter.
- BX proprietary configuration with double o-ring collar 45 mm, suitable to PLUS 3P BX housings, DP housings, K DP housings.
- CX proprietary configuration with double o-ring collar 57 mm, suitable to PLUS 3P CX, K DP housings.

**MODELS:**

- RL A series from 10" to 20" OD 2.40" ID 1.10", SX, BX, CX configurations.

**VARIANTS AVAILABLE ON MINIMUM QUANTITY:**

- RL A series at 30" and 40".

**CERTIFICATIONS**



RL A cartridges are tested and certified under the most stringent procedures worldwide, in compliance with DM 25 (Italy), with the sanitary certification EAC/Ghostreghistracia (Russia) and WaterMark (Australia).

**WORKING CONDITIONS**

Max working temperature \_\_\_\_\_ 45°C (113°F)  
 Min working temperature \_\_\_\_\_ 4°C (39,2°F)

**SPECIFICATIONS**

Non-toxic materials, suitable for drinking water.  
 Filter medium: stainless steel net AISI 316.  
 Armouring and end caps: polypropylene.  
 Flat seals SX: SEBS with antimicrobial technology.  
 O-rings BX and CX: EPDM.

Cartridges with stainless steel net and plastic frame, with consistent water flow and very low pressure drop, filtration at 70 micron. The cartridges are manufactured without glue and sealants, nets are included while molding the structural frame. Available with height 10" and 20".

**RL A SX**

**STAINLESS STEEL AISI 316 WASHABLE NET WITH DOUBLE OPEN END (DOE)**

CODE	MODEL	NOMINAL HEIGHT	NOMINAL FILTRATION MICRON	RECOMMENDED FLOW RATE l/h	DIMENSIONS MM		
					A	B	C
<b>OD 2,40" x ID 1,10"</b>							
RA5465119	RL A 10 SX 70 mcr	10"	70	2500	250	70	30
RA5467119	RL A 20 SX 70 mcr	20"	70	4000	505	70	30

**RL A BX**

**STAINLESS STEEL AISI 316 WASHABLE NET WITH DOUBLE O-RING COLLAR 45 MM**

CODE	MODEL	NOMINAL HEIGHT	NOMINAL FILTRATION MICRON	RECOMMENDED FLOW RATE l/h	DIMENSIONS MM		
					A	B	C
<b>OD 2,40" x ID 1,10"</b>							
RA5465219	RL A 10 BX 70 mcr	10"	70	2500	250	70	30
RA5467219	RL A 20 BX 70 mcr	20"	70	4000	505	70	30

**RL A CX**

**STAINLESS STEEL AISI 316 WASHABLE NET WITH DOUBLE O-RING COLLAR 57 MM**

CODE	MODEL	NOMINAL HEIGHT	NOMINAL FILTRATION MICRON	RECOMMENDED FLOW RATE l/h	DIMENSIONS MM		
					A	B	C
<b>OD 2,40" x ID 1,10"</b>							
RA5465319	RL A 10 CX 70 mcr	10"	70	2500	250	70	40
RA5467319	RL A 20 CX 70 mcr	20"	70	4000	505	70	40

**FLOW RATE vs PRESSURE DROP Δp**

Tests carried on 10" elements type **RL A 10 SX**.  
 Testing mode: 20°C, 3 BAR

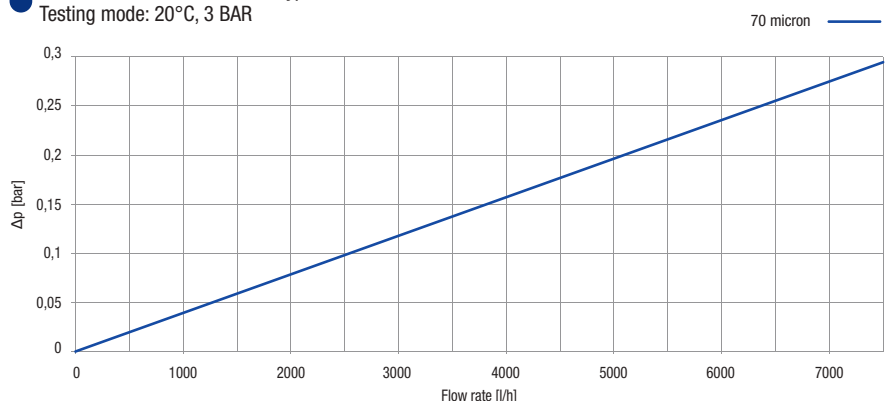



# RA A stainless steel washable net AISI 316

**Sediment filtration.**  
**Average life-span:** from 3 to 5 years.  
**Maintenance:** wash every month at least.

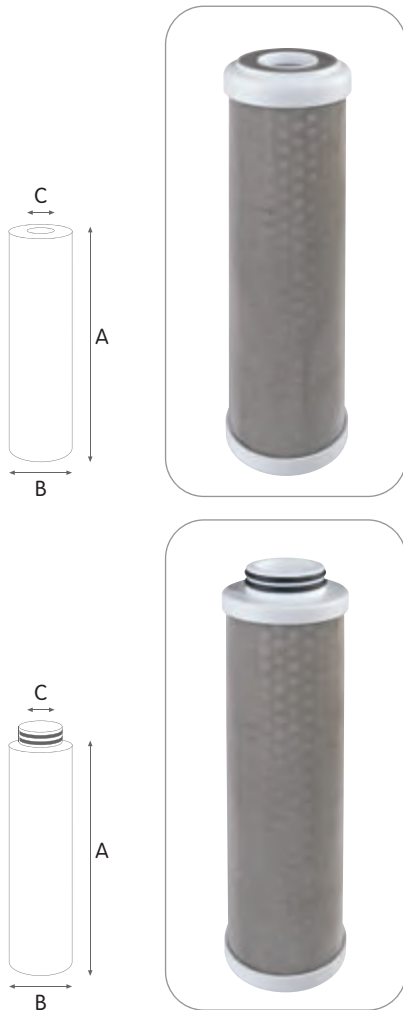

## WORKING CONDITIONS

Max working temperature 80°C (176°F)  
 Min working temperature 4°C (39,2°F)

## SPECIFICATIONS

Non-toxic materials, suitable for drinking water.  
 Filter medium and inner armoring: stainless steel net AISI 316.  
 Inner core and end caps: polypropylene.  
 Flat seals SX: SEBS with antimicrobial technology.  
 O-rings BX and CX: EPDM.

Cartridges with stainless steel net and stainless steel inner armoring, with consistent water flow and very low pressure drop, standard filtration at 70 micron. Easy-to-wash filter net, long term durability of the materials and high collapse resistance make this cartridge range the most suitable for well water filtration. Available in 2 main versions: RA A made with AISI 316 stainless steel, RA C made with AISI 304 stainless steel. Height from 4" to 20".

## RA A SX

### STAINLESS STEEL AISI 316 WASHABLE NET WITH DOUBLE OPEN END (DOE)

CODE	MODEL	NOMINAL HEIGHT	NOMINAL FILTRATION MICRON	RECOMMENDED FLOW RATE l/h	DIMENSIONS MM		
					A	B	C
<b>OD 1,77" x ID 0,71"</b>							
RA5060116	RA MIGNON A SX 70 mcr	5" M	70	800	122	50	20
<b>OD 2,40" x ID 1,10"</b>							
RA5061116	RA 4 A SX 70 mcr	4"	70	1000	101	70	30
RA5062116	RA 5 A SX 70 mcr	5"	70	1200	125	70	30
RA5064116	RA 7 A SX 70 mcr	7"	70	1700	173	70	30
RA5065116	RA 10 A SX 70 mcr	10"	70	2500	250	70	30
RA5067116	RA 20 A SX 70 mcr	20"	70	4000	505	70	30

## RA A BX

### STAINLESS STEEL AISI 316 WASHABLE NET WITH DOUBLE O-RING COLLAR 45 MM

CODE	MODEL	NOMINAL HEIGHT	NOMINAL FILTRATION MICRON	RECOMMENDED FLOW RATE l/h	DIMENSIONS MM		
					A	B	C
<b>OD 2,40" x ID 1,10"</b>							
RA5062216	RA 5 A BX 70 mcr	5"	70	1200	125	70	30
RA5064216	RA 7 A BX 70 mcr	7"	70	1700	173	70	30
RA5065216	RA 10 A BX 70 mcr	10"	70	2500	250	70	30
RA5067216	RA 20 A BX 70 mcr	20"	70	4000	505	70	30

RA cartridges are available in a variety of:

### CONFIGURATIONS:

- SX standard configuration double open end (DOE) available for every height and diameter.
- BX proprietary configuration with double o-ring collar 45 mm, suitable to PLUS 3P BX housings, DP housings, K DP housings.
- CX proprietary configuration with double o-ring collar 57 mm, suitable to PLUS 3P CX, K DP housings.

### MODELS:

- RA MIGNON series 5"M OD 1.77" ID 0.71, SX configuration.
- RA series from 4" to 20" OD 2.40" ID 1.10", SX, BX, CX configurations.

### VARIANTS AVAILABLE ON MINIMUM QUANTITY:

- Filter rates from 100 to 500 micron.

### CERTIFICATIONS



RA cartridges are tested and certified under the most stringent procedures worldwide, in compliance with DM 25 (Italy), with the sanitary certification ACS (France), EAC/Ghostreghistrazia (Russia) and WaterMark (Australia).

## RA A CX

### STAINLESS STEEL AISI 316 WASHABLE NET WITH DOUBLE O-RING COLLAR 57 MM

CODE	MODEL	NOMINAL HEIGHT	NOMINAL FILTRATION MICRON	RECOMMENDED FLOW RATE l/h	DIMENSIONS MM		
					A	B	C
<b>OD 2,40" x ID 1,10"</b>							
RA5065316	RA 10 A CX 70 mcr	10"	70	2500	250	70	40
RA5067316	RA 20 A CX 70 mcr	20"	70	4000	505	70	40



# RA C stainless steel washable net AISI 304

**Sediment filtration.**  
**Average life-span:** from 3 to 5 years.  
**Maintenance:** wash every month at least.

## WORKING CONDITIONS

Max working temperature  $\leq 80^{\circ}\text{C}$  (176°F)  
 Min working temperature  $\geq 4^{\circ}\text{C}$  (39,2°F)

## SPECIFICATIONS

Non-toxic materials, suitable for drinking water.  
 Filter medium and inner armouring: stainless steel net AISI 304.  
 Inner core and end caps: polypropylene.  
 Flat seals SX: SEBS with antimicrobial technology.  
 O-rings BX and CX: EPDM.

## RA C SX

### STAINLESS STEEL AISI 304 WASHABLE NET WITH DOUBLE OPEN END (DOE)

CODE	MODEL	NOMINAL HEIGHT	NOMINAL FILTRATION MICRON	RECOMMENDED FLOW RATE l/h	DIMENSIONS MM		
					A	B	C
<b>OD 1,77" x ID 0,71"</b>							
RA5080116	RA MIGNON C SX 70 mcr	5" M	70	800	122	50	20
<b>OD 2,40" x ID 1,10"</b>							
RA5081116	RA 4 C SX 70 mcr	4"	70	1000	101	70	30
RA5082116	RA 5 C SX 70 mcr	5"	70	1200	125	70	30
RA5084116	RA 7 C SX 70 mcr	7"	70	1700	173	70	30
RA5085116	RA 10 C SX 70 mcr	10"	70	2500	250	70	30
RA5087116	RA 20 C SX 70 mcr	20"	70	4000	505	70	30

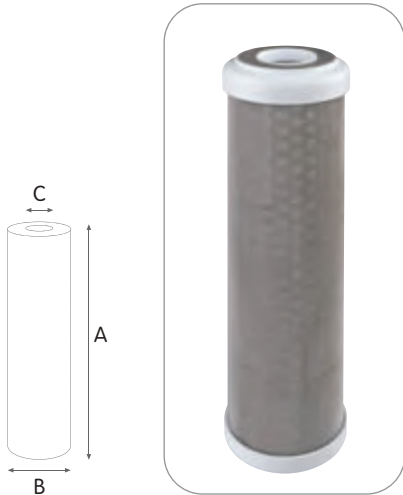

## RA C BX

### STAINLESS STEEL AISI 304 WASHABLE NET WITH DOUBLE O-RING COLLAR 45 MM

CODE	MODEL	NOMINAL HEIGHT	NOMINAL FILTRATION MICRON	RECOMMENDED FLOW RATE l/h	DIMENSIONS MM		
					A	B	C
<b>OD 2,40" x ID 1,10"</b>							
RA5082216	RA 5 C BX 70 mcr	5"	70	1200	125	70	30
RA5084216	RA 7 C BX 70 mcr	7"	70	1700	173	70	30
RA5085216	RA 10 C BX 70 mcr	10"	70	2500	250	70	30
RA5087216	RA 20 C BX 70 mcr	20"	70	4000	505	70	30

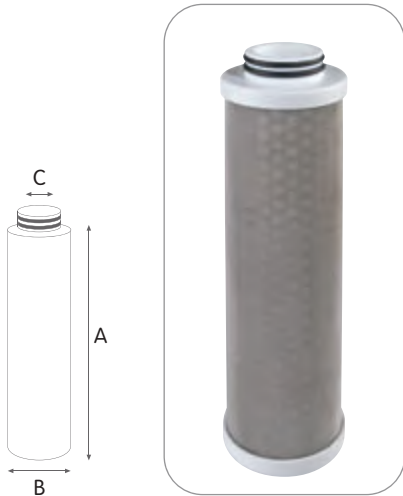

## RA C CX

### STAINLESS STEEL AISI 304 WASHABLE NET WITH DOUBLE O-RING COLLAR 57 MM

CODE	MODEL	NOMINAL HEIGHT	NOMINAL FILTRATION MICRON	RECOMMENDED FLOW RATE l/h	DIMENSIONS MM		
					A	B	C
<b>OD 2,40" x ID 1,10"</b>							
RA5085316	RA 10 C CX 70 mcr	10"	70	2500	250	70	40
RA5087316	RA 20 C CX 70 mcr	20"	70	4000	505	70	40

### FLOW RATE vs PRESSURE DROP $\Delta p$

Tests carried on 10" elements type **RA 10 SX**.  
 Testing mode: 20°C, 3 BAR

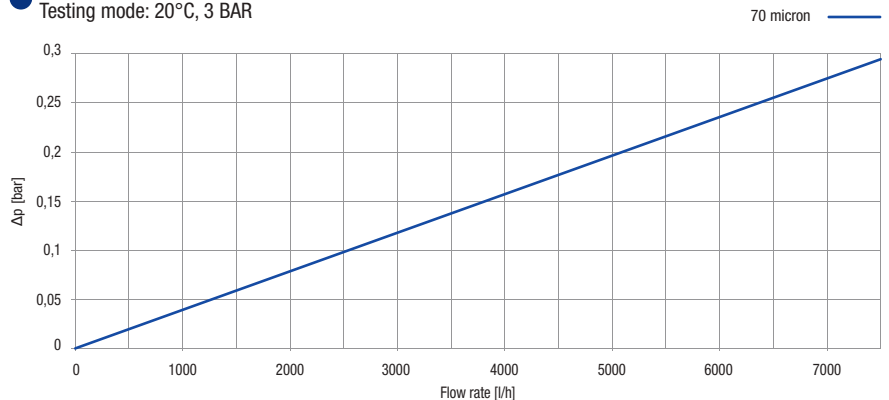



# RA BIG stainless steel washable net

**Sediment filtration.**  
**Average life-span:** from 3 to 5 years.  
**Maintenance:** wash every month at least.

## WORKING CONDITIONS

Max working temperature 80°C (176°F)  
 Min working temperature 4°C (39,2°F)

## SPECIFICATIONS

Non-toxic materials, suitable for drinking water.  
 Filter medium and inner armouring: stainless steel net  
 AISI 316 / AISI 304.  
 Inner core and end caps: polypropylene.  
 Flat seals SX: SEBS with antimicrobial technology.

Range of cartridges with 4,50" outer diameter, made of stainless steel net and stainless steel inner armouring, with consistent water flow and very low pressure drop, standard filtration at 70 micron. Easy-to-wash filter net, long term durability of the materials and high collapse resistance make this cartridge range the most suitable for well water filtration. Available in 2 versions: RA A made with AISI 316 stainless steel, RA C made with AISI 304 stainless steel. Heights 10" and 20".

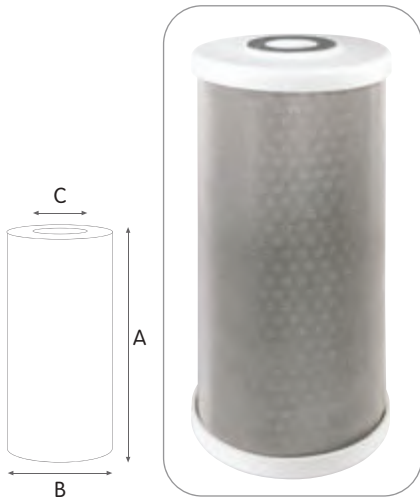

## RA A BIG

### STAINLESS STEEL AISI 316 WASHABLE NET WITH DOUBLE OPEN END (DOE)

CODE	MODEL	NOMINAL HEIGHT	NOMINAL FILTRATION MICRON	RECOMMENDED FLOW RATE l/h	DIMENSIONS MM		
					A	B	C
<b>OD 4,50" x ID 1,10"</b>							
RA5065516	RA 10 A BIG SX 70 mcr	10"	70	3000	250	118	27
RA5067516	RA 20 A BIG SX 70 mcr	20"	70	5000	508	118	27

## RA C BIG

### STAINLESS STEEL AISI 304 WASHABLE NET WITH DOUBLE OPEN END (DOE)

CODE	MODEL	NOMINAL HEIGHT	NOMINAL FILTRATION MICRON	RECOMMENDED FLOW RATE l/h	DIMENSIONS MM		
					A	B	C
<b>OD 4,50" x ID 1,10"</b>							
RA5085516	RA 10 C BIG SX 70 mcr	10"	70	3000	250	118	27
RA5087516	RA 20 C BIG SX 70 mcr	20"	70	5000	508	118	27

RA BIG cartridges are available in a variety of:

### CONFIGURATIONS:

- SX standard configuration double open end (DOE) available for every height and diameter.

### MODELS:

- RA BIG series 10" and 20", OD 4.50", ID 1.10". SX configuration.

### CERTIFICATIONS



RA BIG cartridges are tested and certified under the most stringent procedures worldwide, in compliance with DM 25 (Italy) and with the sanitary certification EAC/Ghostreghistrizia (Russia).

### FLOW RATE vs PRESSURE DROP $\Delta p$

Tests carried on 10" elements type RA 10 BIG.  
 Testing mode: 20°C, 3 BAR

70 micron

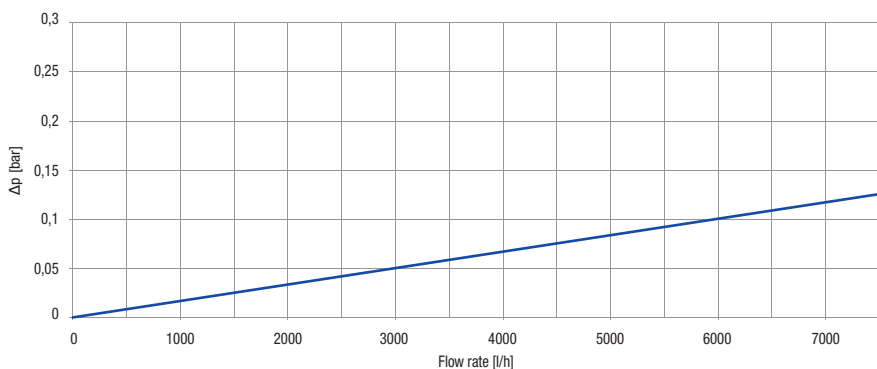



# SA A stainless steel washable net AISI 316

**Sediment filtration.**  
**Average life-span:** from 3 to 5 years.  
**Maintenance:** wash every 3 months.

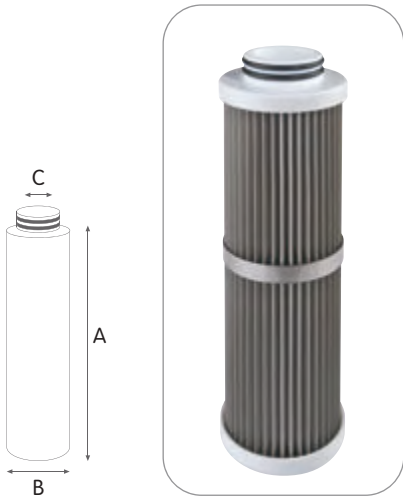
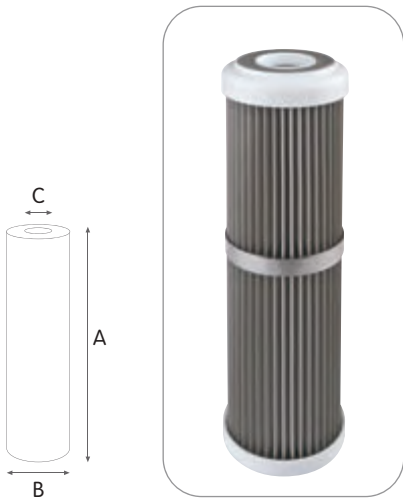

SA cartridges are available in a variety of:

## CONFIGURATIONS:

- SX standard configuration double open end (DOE) available for every height and diameter.
- BX proprietary configuration with double o-ring collar 45 mm, suitable to PLUS 3P BX housings, DP housings, K DP housings.
- CX proprietary configuration with double o-ring collar 57 mm, suitable to PLUS 3P CX, K DP housings.

## MODELS:

- SA MIGNON series 5" M OD 1.77" ID 0.71, SX configuration.
- SA series from 4" to 20" OD 2.40" ID 1.10", SX, BX, CX configurations.

## VARIANTS AVAILABLE ON MINIMUM QUANTITY:

- Filter rates from 100 to 500 micron.

## CERTIFICATIONS



SA cartridges are tested and certified under the most stringent procedures worldwide, in compliance with DM 25 (Italy), with the sanitary certification ACS (France), EAC/Ghostreghistrizia (Russia) and WaterMark (Australia).

## WORKING CONDITIONS

Max working temperature \_\_\_\_\_ 80°C (176°F)  
 Min working temperature \_\_\_\_\_ 4°C (39,2°F)

## SPECIFICATIONS

Non-toxic materials, suitable for drinking water.  
 Filter medium: stainless steel net AISI 316.  
 Inner core and end caps: polypropylene.  
 Flat seals SX: SEBS with antimicrobial technology.  
 O-rings BX and CX: EPDM.

Cartridges with stainless steel pleated net and polypropylene inner core, with consistent water flow and very low pressure drop, standard filtration at 50 micron. SA cartridges perform a very wide filtering surface providing improvement in service time. Available in 2 main versions: SA-A made with AISI 316 stainless steel, SA-C made with AISI 304 stainless steel. Height from 4" to 20".

## SA A SX

### PLEATED STAINLESS STEEL AISI 316 WASHABLE NET WITH DOUBLE OPEN END (DOE)

CODE	MODEL	NOMINAL HEIGHT	NOMINAL FILTRATION MICRON	RECOMMENDED FLOW RATE l/h	DIMENSIONS MM		
					A	B	C
<b>OD 1,77" x ID 0,71"</b>							
RA5050114	SA MIGNON A SX 50 mcr	5" M	50	1000	122	50	20
<b>OD 2,40" x ID 1,10"</b>							
RA5051114	SA 4 A SX 50 mcr	4"	50	1200	101	70	30
RA5052114	SA 5 A SX 50 mcr	5"	50	1500	125	70	30
RA5054114	SA 7 A SX 50 mcr	7"	50	2000	173	70	30
RA5055114	SA 10 A SX 50 mcr	10"	50	3000	250	70	30
RA5057114	SA 20 A SX 50 mcr	20"	50	4500	505	70	30

## SA A BX

### PLEATED STAINLESS STEEL AISI 316 WASHABLE NET WITH DOUBLE O-RING COLLAR 45 MM

CODE	MODEL	NOMINAL HEIGHT	NOMINAL FILTRATION MICRON	RECOMMENDED FLOW RATE l/h	DIMENSIONS MM		
					A	B	C
<b>OD 2,40" x ID 1,10"</b>							
RA5052214	SA 5 A BX 50 mcr	5"	50	1500	125	70	30
RA5054214	SA 7 A BX 50 mcr	7"	50	2000	173	70	30
RA5055214	SA 10 A BX 50 mcr	10"	50	3000	250	70	30
RA5057214	SA 20 A BX 50 mcr	20"	50	4500	505	70	30

## SA A CX

### PLEATED STAINLESS STEEL AISI 316 WASHABLE NET WITH DOUBLE O-RING COLLAR 57 MM

CODE	MODEL	NOMINAL HEIGHT	NOMINAL FILTRATION MICRON	RECOMMENDED FLOW RATE l/h	DIMENSIONS MM		
					A	B	C
<b>OD 2,40" x ID 1,10"</b>							
RA5055314	SA 10 A CX 50 mcr	10"	50	3000	250	70	40
RA5057314	SA 20 A CX 50 mcr	20"	50	4500	505	70	40



# SA C stainless steel washable net AISI 304

## Sediment filtration.

**Average life-span:** from 3 to 5 years.

**Maintenance:** wash every 3 months.

## WORKING CONDITIONS

Max working temperature \_\_\_\_\_ 80°C (176°F)  
Min working temperature \_\_\_\_\_ 4°C (39,2°F)

## SPECIFICATIONS

Non-toxic materials, suitable for drinking water.  
Filter medium: stainless steel net AISI 304.  
Inner core and end caps: polypropylene.  
Flat seals SX: SEBS with antimicrobial technology.  
O-rings BX and CX: EPDM.

## SA C SX

### PLEATED STAINLESS STEEL AISI 304 WASHABLE NET WITH DOUBLE OPEN END (DOE)

CODE	MODEL	NOMINAL HEIGHT	NOMINAL FILTRATION MICRON	RECOMMENDED FLOW RATE l/h	DIMENSIONS MM		
					A	B	C
<b>OD 1,77" x ID 0,71"</b>							
RA5070114	SA MIGNON C SX 50 mcr	5" M	50	1000	122	50	20
<b>OD 2,40" x ID 1,10"</b>							
RA5071114	SA 4 C SX 50 mcr	4"	50	1200	101	70	30
RA5072114	SA 5 C SX 50 mcr	5"	50	1500	125	70	30
RA5074114	SA 7 C SX 50 mcr	7"	50	2000	173	70	30
RA5075114	SA 10 C SX 50 mcr	10"	50	3000	250	70	30
RA5077114	SA 20 C SX 50 mcr	20"	50	4500	505	70	30

## SA C BX

### PLEATED STAINLESS STEEL AISI 304 WASHABLE NET WITH DOUBLE O-RING COLLAR 45 MM

CODE	MODEL	NOMINAL HEIGHT	NOMINAL FILTRATION MICRON	RECOMMENDED FLOW RATE l/h	DIMENSIONS MM		
					A	B	C
<b>OD 2,40" x ID 1,10"</b>							
RA5072214	SA 5 C BX 50 mcr	5"	50	1500	125	70	30
RA5074214	SA 7 C BX 50 mcr	7"	50	2000	173	70	30
RA5075214	SA 10 C BX 50 mcr	10"	50	3000	250	70	30
RA5077214	SA 20 C BX 50 mcr	20"	50	4500	505	70	30

## SA C CX

### PLEATED STAINLESS STEEL AISI 304 WASHABLE NET WITH DOUBLE O-RING COLLAR 57 MM

CODE	MODEL	NOMINAL HEIGHT	NOMINAL FILTRATION MICRON	RECOMMENDED FLOW RATE l/h	DIMENSIONS MM		
					A	B	C
<b>OD 2,40" x ID 1,10"</b>							
RA5075314	SA 10 C CX 50 mcr	10"	50	3000	250	70	40
RA5077314	SA 20 C CX 50 mcr	20"	50	4500	505	70	40

## FLOW RATE vs PRESSURE DROP $\Delta p$

Tests carried on 10" elements type SA 10 SX.

Testing mode: 20°C, 3 BAR

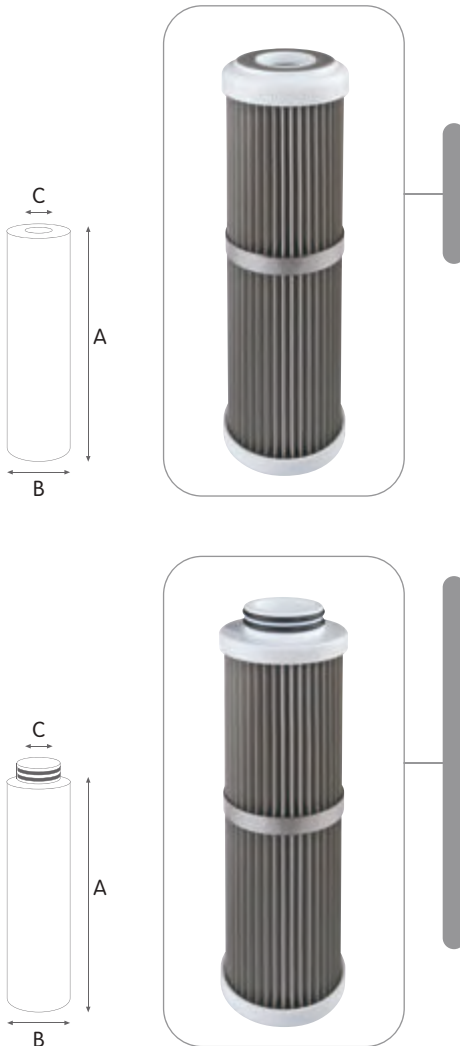
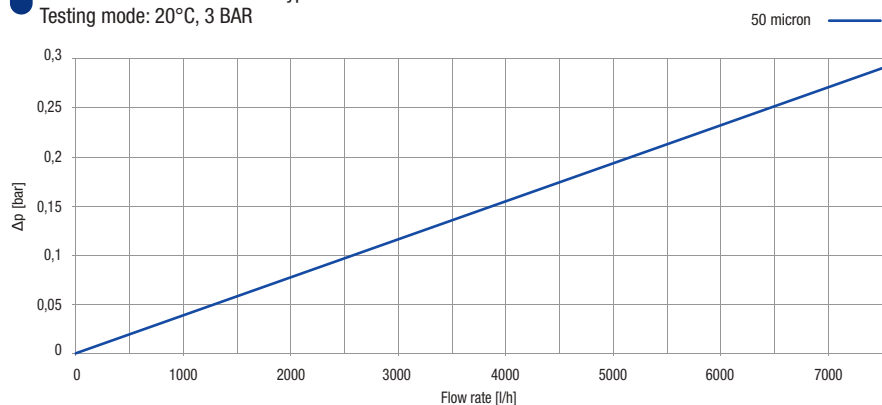





# SA BIG stainless steel washable net

**Sediment filtration.**  
**Average life-span:** from 3 to 5 years.  
**Maintenance:** wash every 3 months.

## WORKING CONDITIONS

Max working temperature \_\_\_\_\_ 80°C (176°F)  
 Min working temperature \_\_\_\_\_ 4°C (39,2°F)

## SPECIFICATIONS

Non-toxic materials, suitable for drinking water.  
 Filter medium: stainless steel net AISI 316 / AISI 304.  
 Inner core and end caps: polypropylene.  
 Flat seals SX: SEBS with antimicrobial technology.

Range of cartridges with 4,50" outer diameter, made of pleated stainless steel net and polypropylene inner core, with large filtering surface, consistent water flow and very low pressure drop, standard filtration at 50 micron. Available in 2 versions: SA-A made with AISI 316 stainless steel, SA-C made with AISI 304 stainless steel. Heights 10" and 20".

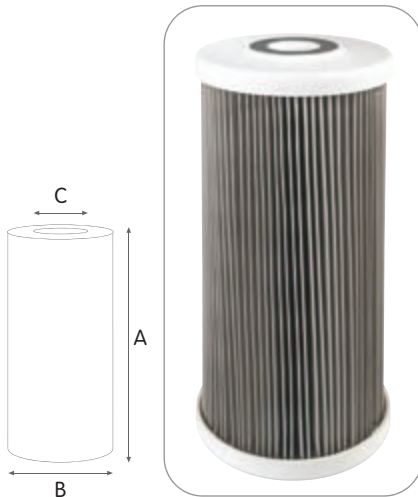

## SA A BIG

### PLEATED STAINLESS STEEL AISI 316 WASHABLE NET WITH DOUBLE OPEN END (DOE)

CODE	MODEL	NOMINAL HEIGHT	NOMINAL FILTRATION MICRON	RECOMMENDED FLOW RATE l/h	DIMENSIONS MM		
					A	B	C
<b>OD 4,50" x ID 1,10"</b>							
RA5055514	SA 10 A BIG SX 50 mcr	10"	50	4000	250	118	27
RA5057514	SA 20 A BIG SX 50 mcr	20"	50	6000	508	118	27

## SA C BIG

### PLEATED STAINLESS STEEL AISI 304 WASHABLE NET WITH DOUBLE OPEN END (DOE)

CODE	MODEL	NOMINAL HEIGHT	NOMINAL FILTRATION MICRON	RECOMMENDED FLOW RATE l/h	DIMENSIONS MM		
					A	B	C
<b>OD 4,50" x ID 1,10"</b>							
RA5075514	SA 10 C BIG SX 50 mcr	10"	50	4000	250	118	27
RA5077514	SA 20 C BIG SX 50 mcr	20"	50	6000	508	118	27

SA BIG cartridges are available in a variety of:

### CONFIGURATIONS:

- SX standard configuration double open end (DOE) available for every height and diameter.

### MODELS:

- SA BIG series 10" and 20", OD 4.50", ID 1.10". SX configuration.

### CERTIFICATIONS



SA BIG cartridges are tested and certified under the most stringent procedures worldwide, **in compliance with DM 25 (Italy) and with the sanitary certification EAC/Ghostreghistracia (Russia).**

### FLOW RATE vs PRESSURE DROP $\Delta p$

Tests carried on 10" elements type **RA 10 BIG**.  
 Testing mode: 20°C, 3 BAR

50 micron

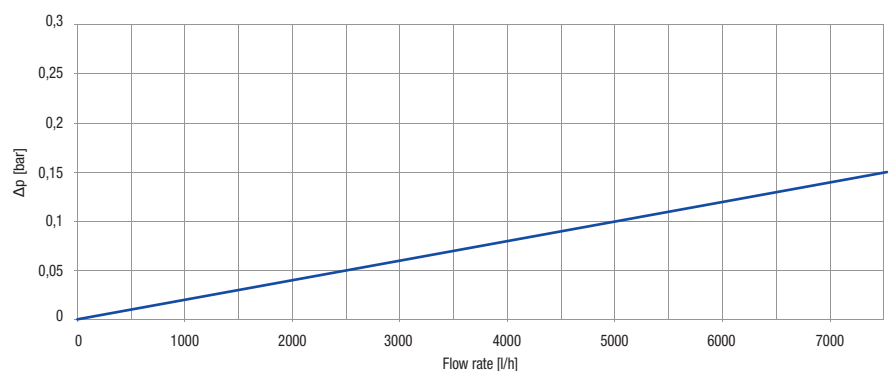



# RS pleated polypropylene washable net

## Sediment filtration.

**Average life-span:** about 24 months.

**Maintenance:** wash every 3 months.

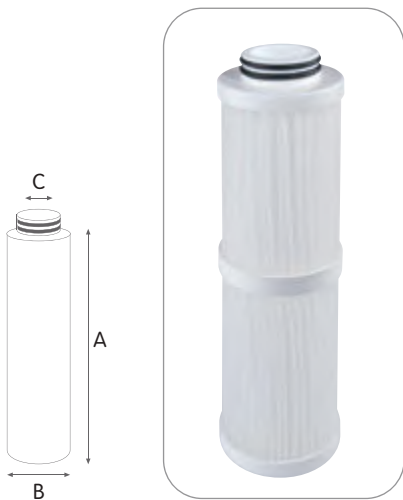
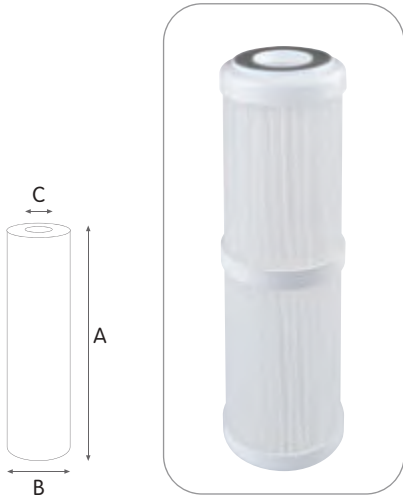

## WORKING CONDITIONS

Max working temperature \_\_\_\_\_ 45°C (113°F)  
 Min working temperature \_\_\_\_\_ 4°C (39,2°F)

## SPECIFICATIONS

Non-toxic materials, suitable for drinking water.  
 Filter medium: polypropylene net.  
 Inner core and end caps: polypropylene.  
 Flat seals SX: SEBS with antimicrobial technology.  
 O-rings BX and CX: EPDM.

Washable net cartridges fully made with polypropylene designed to provide high water flow at very low pressure drop, filtration at 50 micron. RS cartridges have a very wide filtering surface providing improvement in service time. Height from 4" to 20".

## RS SX

### PLEATED POLYPROPYLENE WASHABLE NET WITH DOUBLE OPEN END (DOE)

CODE	MODEL	NOMINAL HEIGHT	NOMINAL FILTRATION MICRON	RECOMMENDED FLOW RATE l/h	DIMENSIONS MM		
					A	B	C
<b>OD 2,40" x ID 1,10"</b>							
RA5021114	RS 4 SX 50 mcr	4"	50	1000	101	70	30
RA5022114	RS 5 SX 50 mcr	5"	50	1200	125	70	30
RA5024114	RS 7 SX 50 mcr	7"	50	1700	173	70	30
RA5025114	RS 10 SX 50 mcr	10"	50	2500	250	70	30
RA5027114	RS 20 SX 50 mcr	20"	50	4000	505	70	30

## RS BX

### PLEATED POLYPROPYLENE WASHABLE NET WITH DOUBLE O-RING COLLAR 45 MM

CODE	MODEL	NOMINAL HEIGHT	NOMINAL FILTRATION MICRON	RECOMMENDED FLOW RATE l/h	DIMENSIONS MM		
					A	B	C
<b>OD 2,40" x ID 1,10"</b>							
RA5022214	RS 5 BX 50 mcr	5"	50	1200	125	70	30
RA5024214	RS 7 BX 50 mcr	7"	50	1700	173	70	30
RA5025214	RS 10 BX 50 mcr	10"	50	2500	250	70	30
RA5027214	RS 20 BX 50 mcr	20"	50	4000	505	70	30

## RS CX

### PLEATED POLYPROPYLENE WASHABLE NET WITH DOUBLE O-RING COLLAR 57 MM

CODE	MODEL	NOMINAL HEIGHT	NOMINAL FILTRATION MICRON	RECOMMENDED FLOW RATE l/h	DIMENSIONS MM		
					A	B	C
<b>OD 2,40" x ID 1,10"</b>							
RA5025314	RS 10 CX 50 mcr	10"	50	2500	250	70	40
RA5027314	RS 20 CX 50 mcr	20"	50	4000	505	70	40

RS are available in a variety of:

## CONFIGURATIONS:

- SX standard configuration double open end (DOE) available for every height and diameter.
- BX proprietary configuration with double o-ring collar 45 mm, suitable to PLUS 3P BX housings, DP housings, K DP housings.
- CX proprietary configuration with double o-ring collar 57 mm, suitable to PLUS 3P CX, K DP housings.

## MODELS:

- RS series from 4" to 40" OD 2.40" ID 1.10", SX, BX, CX configurations.

## CERTIFICATIONS



RS cartridges are tested and certified under the most stringent procedures worldwide, in compliance with DM 25 (Italy), with the sanitary certification ACS (France), EAC/Ghostreghistracia (Russia) and WaterMark (Australia).

## FLOW RATE vs PRESSURE DROP Δp

Tests carried on 10" elements type **RS 10 SX**.  
 Testing mode: 20°C, 3 BAR

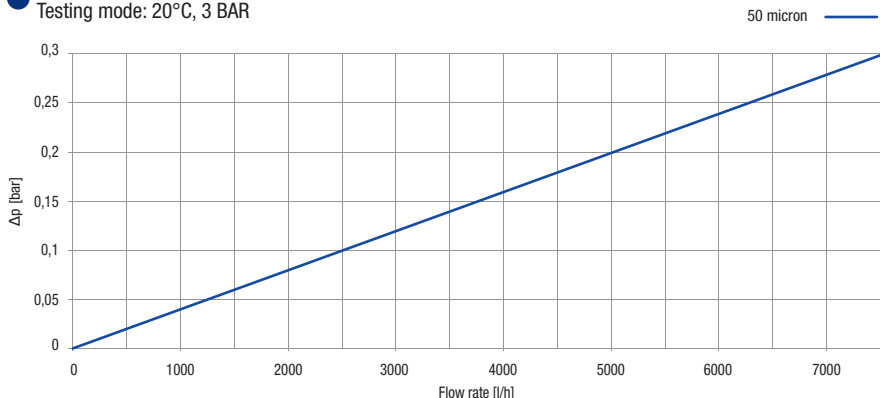

SEDIMENT CARTRIDGES





SANIC

WATER FILTERS WITH  
ANTIMICROBIAL  
TECHNOLOGY

SEDIMENT  
CARTRIDGES

# SANIC SEDIMENT CARTRIDGES

filter cartridges with antimicrobial technology

Range of sediment filter cartridges with antimicrobial product protection provided by a silver based antimicrobial agent included in the plastic matrix with a specific technology

Powered by Microban® antimicrobial technology   
**MICROBAN**®

Microban® technology is not designed to purify drinking water, but to fight the growth of stain and odor causing bacteria on the housing and filter itself which could adversely affect filter life and performance.  
MICROBAN is a registered trademark of Microban Products Company.

# SANIC CARTRIDGES CONFIGURATION

## FOR FILTERS SX and BX

SANIC cartridges with antimicrobial technology are available in 2 end-caps configurations:

- SX standard configuration double open end (DOE), fit to SANIC SX housings, to Atlas Filtri SX housings and to major part of housings in the market.
- BX proprietary configuration with double o-ring, for perfect watertight fit, and for safe, simple and rapid maintenance operations, perfect cartridge standing and elimination of wrong positioning. All of that with market exclusivity.

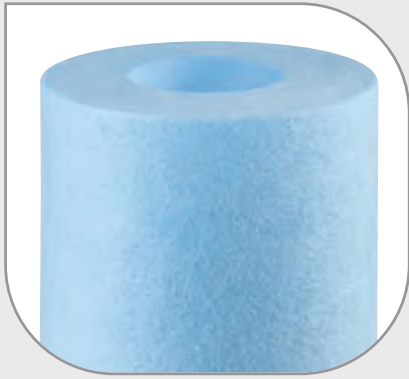

**SX** **Standard double open end (DOE) configuration with flat seals.**  
Fit to SX housings, DP housings, Depural®, Depural® Top, Bravo DP, Oasis DP.



**BX** **Quick-fit configuration with 45 mm double o-ring collar.**  
Fit to Plus 3P BX housings, DP housings, K DP housings, Depural® Top, Bravo DP, Oasis DP.

## TERMS LEGEND

### Filtration

Filter rate in micron.

### Flow rate

In liters per hour (l/h), the flow rate for ideal filtration using a new cartridge.

### Average life-span

The average working life of the cartridge. Working life depends on the type of application, and on the level of filtration, the cartridge material, the type of maintenance that can be carried out and, especially, depends on the quality of the water being treated. The quality of the water is an extremely variable factor and thus the average life-span is indicated for a mains water supply with average European potable water characteristics.

### Maintenance

Type and frequency of applicable maintenance operations.

## CARTRIDGES RANGE

### Cartridges for sediment filtration

#### FILTRATION IN DEPTH

**FA SANIC** - wound polypropylene thread.

Filtration from 1 to 100 micron.

**CPP SANIC** - melt-blown polypropylene smooth.

Filtration from 1 to 50 micron.

## SYMBOLS LEGEND



For domestic use



For technical and industrial use



# FA SANIC polypropylene wound thread

**Sediment filtration.**  
**Average life-span:** 6 months.  
**Maintenance:** none.

**WORKING CONDITIONS**

Max working temperature \_\_\_\_\_ 45°C (113°F)  
 Min working temperature \_\_\_\_\_ 4°C (39,2°F)

**SPECIFICATIONS**

Non-toxic materials, suitable for drinking water.  
 Filter medium: PP thread with antimicrobial technology.  
 Inner core: polypropylene.

A wide range of filter cartridges with antimicrobial technology made with polypropylene thread featuring a silver based antimicrobial agent, wound on polypropylene or reinforced polypropylene inner core, available in a variety of filter rates, heights, diameters and configurations.

Atlas Filtri FA SANIC wound cartridges are made of uniform and consistent polypropylene thread, strong and homogeneous, which makes a compact cartridge construction resulting in a larger filtration surface with improvement in filtration efficiency and in life-span, with a higher cost/effective ratio as a result. The inner core is made rigid and with particular solutions to achieve the maximum rigidity for every height from 4" to 40". FA SANIC cartridges with antimicrobial technology are the most appropriate sediment filter cartridges for all drinking water applications.

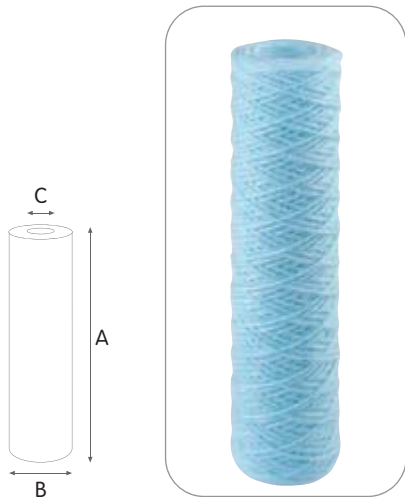

**FA SANIC SX**

**WOUND POLYPROPYLENE THREAD CARTRIDGES WITH DOUBLE OPEN END (DOE)**

CODE	MODEL	NOMINAL HEIGHT	NOMINAL FILTRATION MICRON	RECOMMENDED FLOW RATE l/h	DIMENSIONS MM		
					A	B	C
<b>OD 1,77" x ID 0,71"</b>							
SA5110408	FA MIGNON SANIC SX 5 mcr	5" M	5	500	122	45	18
SA5110409	FA MIGNON SANIC SX 10 mcr	5" M	10	500	122	45	18
SA5110411	FA MIGNON SANIC SX 25 mcr	5" M	25	500	122	45	18
SA5110414	FA MIGNON SANIC SX 50 mcr	5" M	50	500	122	45	18
SA5110419	FA MIGNON SANIC SX 100 mcr	5" M	100	500	122	45	18
<b>OD 2,20" x ID 1,10"</b>							
SA5125408	FA 10 R SANIC SX 5 mcr	10"	5	1500	250	56	28
SA5125409	FA 10 R SANIC SX 10 mcr	10"	10	1500	250	56	28
SA5125411	FA 10 R SANIC SX 25 mcr	10"	25	1500	250	56	28
SA5125414	FA 10 R SANIC SX 50 mcr	10"	50	1500	250	56	28
<b>OD 2,40" x ID 1,10"</b>							
SA5111406	FA 4 SANIC SX 1 mcr	4"	1	800	103	61	28
SA5111408	FA 4 SANIC SX 5 mcr	4"	5	800	103	61	28
SA5111409	FA 4 SANIC SX 10 mcr	4"	10	800	103	61	28
SA5111411	FA 4 SANIC SX 25 mcr	4"	25	800	103	61	28
SA5111414	FA 4 SANIC SX 50 mcr	4"	50	800	103	61	28
SA5111419	FA 4 SANIC SX 100 mcr	4"	100	800	103	61	28
SA5112406	FA 5 SANIC SX 1 mcr	5"	1	1000	125	61	28
SA5112408	FA 5 SANIC SX 5 mcr	5"	5	1000	125	61	28
SA5112409	FA 5 SANIC SX 10 mcr	5"	10	1000	125	61	28
SA5112411	FA 5 SANIC SX 25 mcr	5"	25	1000	125	61	28
SA5112414	FA 5 SANIC SX 50 mcr	5"	50	1000	125	61	28
SA5112419	FA 5 SANIC SX 100 mcr	5"	100	1000	125	61	28
SA5114406	FA 7 SANIC SX 1 mcr	7"	1	1400	173	61	28
SA5114408	FA 7 SANIC SX 5 mcr	7"	5	1400	173	61	28
SA5114409	FA 7 SANIC SX 10 mcr	7"	10	1400	173	61	28
SA5114411	FA 7 SANIC SX 25 mcr	7"	25	1400	173	61	28
SA5114414	FA 7 SANIC SX 50 mcr	7"	50	1400	173	61	28
SA5114419	FA 7 SANIC SX 100 mcr	7"	100	1400	173	61	28
SA5115406	FA 10 SANIC SX 1 mcr	10"	1	2000	250	61	28
SA5115408	FA 10 SANIC SX 5 mcr	10"	5	2000	250	61	28
SA5115409	FA 10 SANIC SX 10 mcr	10"	10	2000	250	61	28
SA5115411	FA 10 SANIC SX 25 mcr	10"	25	2000	250	61	28
SA5115414	FA 10 SANIC SX 50 mcr	10"	50	2000	250	61	28
SA5115419	FA 10 SANIC SX 100 mcr	10"	100	2000	250	61	28
SA5117406	FA 20 SANIC SX 1 mcr	20"	1	3000	505	61	28
SA5117408	FA 20 SANIC SX 5 mcr	20"	5	3000	505	61	28
SA5117409	FA 20 SANIC SX 10 mcr	20"	10	3000	505	61	28
SA5117411	FA 20 SANIC SX 25 mcr	20"	25	3000	505	61	28
SA5117414	FA 20 SANIC SX 50 mcr	20"	50	3000	505	61	28
SA5117419	FA 20 SANIC SX 100 mcr	20"	100	3000	505	61	28
SA5118406	FA 30 SANIC SX 1 mcr	30"	1	4000	755	61	28
SA5118408	FA 30 SANIC SX 5 mcr	30"	5	4000	755	61	28
SA5118409	FA 30 SANIC SX 10 mcr	30"	10	4000	755	61	28
SA5118411	FA 30 SANIC SX 25 mcr	30"	25	4000	755	61	28
SA5118414	FA 30 SANIC SX 50 mcr	30"	50	4000	755	61	28
SA5118419	FA 30 SANIC SX 100 mcr	30"	100	4000	755	61	28
SA5119406	FA 40 SANIC SX 1 mcr	40"	1	5000	1015	61	28
SA5119408	FA 40 SANIC SX 5 mcr	40"	5	5000	1015	61	28
SA5119409	FA 40 SANIC SX 10 mcr	40"	10	5000	1015	61	28
SA5119411	FA 40 SANIC SX 25 mcr	40"	25	5000	1015	61	28
SA5119414	FA 40 SANIC SX 50 mcr	40"	50	5000	1015	61	28
SA5119419	FA 40 SANIC SX 100 mcr	40"	100	5000	1015	61	28

FA SANIC cartridges are available in a variety of:

**CONFIGURATIONS:**

- SX standard configuration double open end (DOE) available for every height and diameter.
- BX proprietary configuration with double o-ring collar 45 mm, suitable to PLUS 3P BX housings, DP housings, K DP housings.

**MODELS:**

- FA MIGNON SANIC series 5"M, OD 1.77" ID 0.71". SX configuration
- FA-R SANIC series 10", OD 2.20", ID 1.10". SX configuration
- FA SANIC series from 4" to 40", OD 2.40", ID 1.10". SX, BX configurations

**VARIANTS AVAILABLE ON MINIMUM QUANTITY:**

- FA SANIC CX with double o-ring collar 57 mm, suitable to PLUS 3P CX, K DP housings.

**CERTIFICATIONS**



10" Sanic cartridges in combination with Sanic housings as complete systems are tested and certified by IAPMO RT against NSF/ANSI 42 for bacteriostasis effect. Components tested and certified by IAPMO RT against NSF/ANSI Standards 42 and 61 for material and structural integrity requirements only. In compliance with Drinking Water Treatment Units regulations, USA and Canada.



FA SANIC cartridges are tested and certified under the most stringent procedures worldwide, in compliance with DM 25 (Italy), with the sanitary certification ACS (France), EAC/Ghostreghistracia (Russia) and WaterMark (Australia).

SEDIMENT CARTRIDGES



**Sediment filtration.**  
**Average life-span:** 6 months.  
**Maintenance:** none.

**WORKING CONDITIONS**

Max working temperature \_\_\_\_\_ 45°C (113°F)  
 Min working temperature \_\_\_\_\_ 4°C (39,2°F)

**SPECIFICATIONS**

Non-toxic materials, suitable for drinking water.  
 Filter medium: polypropylene thread with antimicrobial technology.  
 Inner core: polypropylene.  
 O-rings: EPDM.

**FA SANIC BX**

**WOUND POLYPROPYLENE THREAD CARTRIDGES WITH DOUBLE O-RING COLLAR 45 MM**

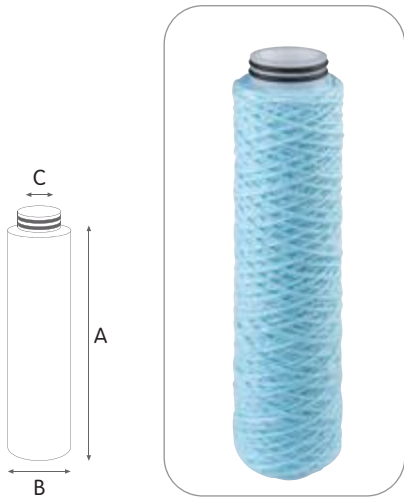

CODE	MODEL	NOMINAL HEIGHT	NOMINAL FILTRATION MICRON	RECOMMENDED FLOW RATE l/h	DIMENSIONS MM		
					A	B	C
<b>OD 2,40" x ID 1,10"</b>							
SA5112206	FA 5 SANIC BX 1 mcr	5"	1	1000	125	61	30
SA5112208	FA 5 SANIC BX 5 mcr	5"	5	1000	125	61	30
SA5112209	FA 5 SANIC BX 10 mcr	5"	10	1000	125	61	30
SA5112211	FA 5 SANIC BX 25 mcr	5"	25	1000	125	61	30
SA5112214	FA 5 SANIC BX 50 mcr	5"	50	1000	125	61	30
SA5112219	FA 5 SANIC BX 100 mcr	5"	100	1000	125	61	30
SA5114206	FA 7 SANIC BX 1 mcr	7"	1	1400	173	61	30
SA5114208	FA 7 SANIC BX 5 mcr	7"	5	1400	173	61	30
SA5114209	FA 7 SANIC BX 10 mcr	7"	10	1400	173	61	30
SA5114211	FA 7 SANIC BX 25 mcr	7"	25	1400	173	61	30
SA5114214	FA 7 SANIC BX 50 mcr	7"	50	1400	173	61	30
SA5114219	FA 7 SANIC BX 100 mcr	7"	100	1400	173	61	30
SA5115206	FA 10 SANIC BX 1 mcr	10"	1	2000	250	61	30
SA5115208	FA 10 SANIC BX 5 mcr	10"	5	2000	250	61	30
SA5115209	FA 10 SANIC BX 10 mcr	10"	10	2000	250	61	30
SA5115211	FA 10 SANIC BX 25 mcr	10"	25	2000	250	61	30
SA5115214	FA 10 SANIC BX 50 mcr	10"	50	2000	250	61	30
SA5115219	FA 10 SANIC BX 100 mcr	10"	100	2000	250	61	30
SA5117206	FA 20 SANIC BX 1 mcr	20"	1	3000	505	61	25
SA5117208	FA 20 SANIC BX 5 mcr	20"	5	3000	505	61	25
SA5117209	FA 20 SANIC BX 10 mcr	20"	10	3000	505	61	25
SA5117211	FA 20 SANIC BX 25 mcr	20"	25	3000	505	61	25
SA5117214	FA 20 SANIC BX 50 mcr	20"	50	3000	505	61	25
SA5117219	FA 20 SANIC BX 100 mcr	20"	100	3000	505	61	25

**FLOW RATE vs PRESSURE DROP  $\Delta p$**

Tests carried on 10" elements type **FA 10 SANIC SX**.  
 Testing mode: 20°C, 3 BAR

- 1 micron —
- 5 micron —
- 10 micron —
- 25 micron —
- 50 micron —
- 100 micron —

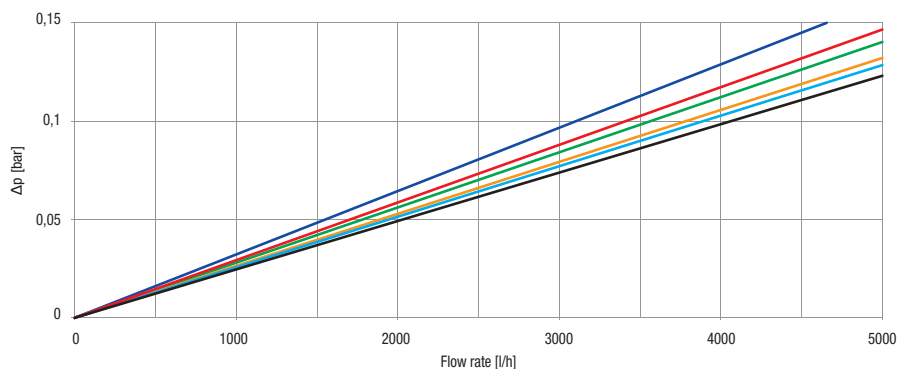



# FA BIG SANIC polypropylene thread wound thread

**Sediment filtration.**  
**Average life-span:** 6 months.  
**Maintenance:** none.

**WORKING CONDITIONS**

Max working temperature \_\_\_\_\_ 45°C (113°F)  
 Min working temperature \_\_\_\_\_ 4°C (39,2°F)

**SPECIFICATIONS**

Non-toxic materials, suitable for drinking water.  
 Filter medium: polypropylene thread with antimicrobial technology.  
 Inner core: polypropylene.

A range of 4.50" OD filter cartridges with antimicrobial technology made with polypropylene thread featuring a silver based antimicrobial agent, wound on polypropylene inner core, designed to fit to DP BIG housings and respond to the most effective heavy-duty sediment filtration requirements, suitable to industrial as well as domestic applications. Atlas Filtri FA BIG SANIC wound cartridges are made of uniform and consistent polypropylene thread, strong and homogeneous, which makes a compact cartridge construction resulting in a larger filtration surface with improvement in filtration efficiency and in life-span, with a higher cost/effective ratio as a result. FA BIG SANIC at height 10" and 20" are available with single layer filtration and with multi-layer filtration, providing progressive filtration in depth for efficiency improvement.

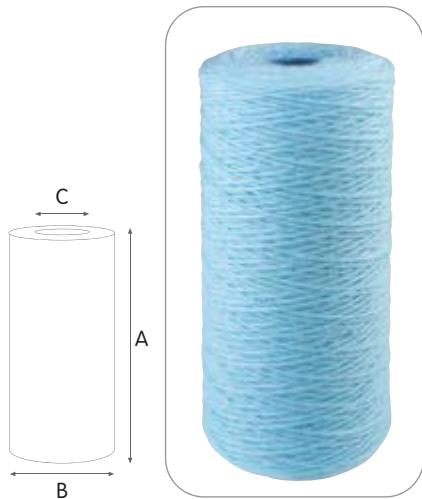

## FA BIG SANIC SX

**WOUND POLYPROPYLENE THREAD CARTRIDGES WITH DOUBLE OPEN END (DOE)**

CODE	MODEL	NOMINAL HEIGHT	NOMINAL FILTRATION MICRON	RECOMMENDED FLOW RATE l/h	DIMENSIONS MM		
					A	B	C
<b>OD 4,50" x ID 1,10"</b>							
SA5115506	FA 10 BIG SANIC SX 1 mcr	10"	1	2500	250	110	28
SA5115508	FA 10 BIG SANIC SX 5 mcr	10"	5	2500	250	110	28
SA5115509	FA 10 BIG SANIC SX 10 mcr	10"	10	2500	250	110	28
SA5115511	FA 10 BIG SANIC SX 25 mcr	10"	25	2500	250	110	28
SA5115514	FA 10 BIG SANIC SX 50 mcr	10"	50	2500	250	110	28
SA5115519	FA 10 BIG SANIC SX 100 mcr	10"	100	2500	250	110	28
SA5117506	FA 20 BIG SANIC SX 1 mcr	20"	1	4000	505	110	28
SA5117508	FA 20 BIG SANIC SX 5 mcr	20"	5	4000	505	110	28
SA5117509	FA 20 BIG SANIC SX 10 mcr	20"	10	4000	505	110	28
SA5117511	FA 20 BIG SANIC SX 25 mcr	20"	25	4000	505	110	28
SA5117514	FA 20 BIG SANIC SX 50 mcr	20"	50	4000	505	110	28
SA5117519	FA 20 BIG SANIC SX 100 mcr	20"	100	4000	505	110	28

## FA BIG MULTI LAYER SANIC SX

**WOUND POLYPROPYLENE THREAD CARTRIDGES WITH DOUBLE OPEN END (DOE)**

CODE	MODEL	NOMINAL HEIGHT	NOMINAL FILTRATION MICRON	RECOMMENDED FLOW RATE l/h	DIMENSIONS MM		
					A	B	C
<b>OD 4,50" x ID 1,10"</b>							
SA5115520	FA 10 BIG MULTI LAYER SANIC SX 10 1 mcr	10"	10 - 1	2500	250	110	28
SA5115521	FA 10 BIG MULTI LAYER SANIC SX 25 1 mcr	10"	25 - 1	2500	250	110	28
SA5115522	FA 10 BIG MULTI LAYER SANIC SX 50 5 mcr	10"	50 - 5	2500	250	110	28
SA5115523	FA 10 BIG MULTI LAYER SANIC SX 50 10 mcr	10"	50 - 10	2500	250	110	28
SA5115528	FA 10 BIG MULTI LAYER SANIC SX 100 25 mcr	10"	100 - 25	2500	250	110	28
SA5115529	FA 10 BIG MULTI LAYER SANIC SX 100 50 mcr	10"	100 - 50	2500	250	110	28
SA5117520	FA 20 BIG MULTI LAYER SANIC SX 10 1 mcr	20"	10 - 1	4000	505	110	28
SA5117521	FA 20 BIG MULTI LAYER SANIC SX 25 1 mcr	20"	25 - 1	4000	505	110	28
SA5117522	FA 20 BIG MULTI LAYER SANIC SX 50 5 mcr	20"	50 - 5	4000	505	110	28
SA5117523	FA 20 BIG MULTI LAYER SANIC SX 50 10 mcr	20"	50 - 10	4000	505	110	28
SA5117528	FA 20 BIG MULTI LAYER SANIC SX 100 25 mcr	20"	100 - 25	4000	505	110	28
SA5117529	FA 20 BIG MULTI LAYER SANIC SX 100 50 mcr	20"	100 - 50	4000	505	110	28

FA BIG SANIC cartridges are available in a variety of:

**CONFIGURATIONS:**

- SX standard configuration double open end (DOE) available for every height and diameter.

**MODELS:**

- FA BIG SANIC series 10" and 20", OD 4.50", ID 1.10". SX configuration
- FA BIG SANIC MULTI-LAYER series 10" and 20", OD 4.50", ID 1.10". SX configuration

**CERTIFICATIONS**



10" Sanic cartridges in combination with Sanic housings as complete systems are tested and certified by IAPMO RT against NSF/ANSI 42 for bacteriostasis effect. Components tested and certified by IAPMO RT against NSF/ANSI Standards 42 and 61 for material and structural integrity requirements only. In compliance with Drinking Water Treatment Units regulations, USA and Canada.



FA BIG SANIC cartridges are tested and certified under the most stringent procedures worldwide, in compliance with DM 25 (Italy), with the sanitary certification EAC/Ghostreghistrizia (Russia) and WaterMark (Australia).

**FLOW RATE vs PRESSURE DROP Δp**

Tests carried on 10" elements type FA 10 BIG SANIC SX.  
 Testing mode: 20°C, 3 BAR

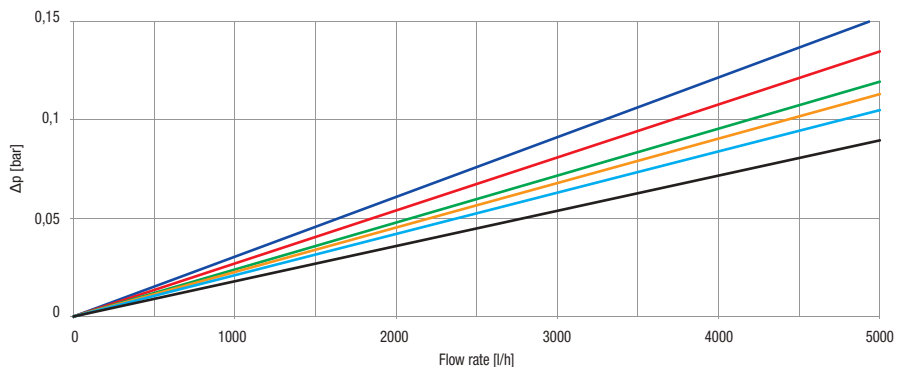

Some items in the list are subject to minimum order quantities and/or to longer delivery term.

SEDIMENT CARTRIDGES



# CPP SANIC melt-blown polypropylene

**Sediment filtration.**  
**Average life-span:** 6 months.  
**Maintenance:** none.

**WORKING CONDITIONS**

Max working temperature \_\_\_\_\_ 80°C (176°F)  
 Min working temperature \_\_\_\_\_ 4°C (39,2°F)

**SPECIFICATIONS**

Non-toxic materials, suitable for drinking water.  
 Filter medium: polypropylene with antimicrobial technology.

Atlas Filtri high efficiency melt-blown polypropylene cartridges with antimicrobial technology featuring a silver based antimicrobial agent are manufactured in specific plant which includes the standardization of production with dedicated software at every process' stage, thermal insulation at controlled temperature, full automation of the whole production line, from the raw-material loading to the finished product packing, without operator direct contact with the product, granting full hygienic safety. Certified raw materials, high productivity and quick delivery time, flexibility of production and custom made products complete the benefits of the range. CPP SANIC cartridges height ranges from 4" to 50". CPP SANIC cartridges with antimicrobial technology are the most appropriate sediment filter cartridges for all drinking water applications.

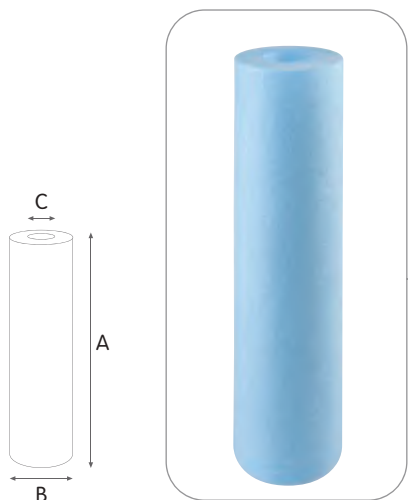

## CPP SANIC SX

**POLYPROPYLENE MELT-BLOWN SMOOTH CARTRIDGES WITH DOUBLE OPEN END (DOE)**

CODE	MODEL	NOMINAL HEIGHT	NOMINAL FILTRATION MICRON	RECOMMENDED FLOW RATE l/h	DIMENSIONS MM		
					A	B	C
<b>OD 2,40" x ID 1,10"</b>							
SA5703506	CPP 4 SANIC SX 1 mcr	4"	1	800	101	61	28
SA5703508	CPP 4 SANIC SX 5 mcr	4"	5	800	101	61	28
SA5703509	CPP 4 SANIC SX 10 mcr	4"	10	800	101	61	28
SA5703511	CPP 4 SANIC SX 25 mcr	4"	25	800	101	61	28
SA5703514	CPP 4 SANIC SX 50 mcr	4"	50	800	101	61	28
SA5704506	CPP 5 SANIC SX 1 mcr	5"	1	1000	125	61	28
SA5704508	CPP 5 SANIC SX 5 mcr	5"	5	1000	125	61	28
SA5704509	CPP 5 SANIC SX 10 mcr	5"	10	1000	125	61	28
SA5704511	CPP 5 SANIC SX 25 mcr	5"	25	1000	125	61	28
SA5704514	CPP 5 SANIC SX 50 mcr	5"	50	1000	125	61	28
SA5705506	CPP 7 SANIC SX 1 mcr	7"	1	1400	173	61	28
SA5705508	CPP 7 SANIC SX 5 mcr	7"	5	1400	173	61	28
SA5705509	CPP 7 SANIC SX 10 mcr	7"	10	1400	173	61	28
SA5705511	CPP 7 SANIC SX 25 mcr	7"	25	1400	173	61	28
SA5705514	CPP 7 SANIC SX 50 mcr	7"	50	1400	173	61	28
SA5706506	CPP 10 SANIC SX 1 mcr	10"	1	2000	250	61	28
SA5706508	CPP 10 SANIC SX 5 mcr	10"	5	2000	250	61	28
SA5706509	CPP 10 SANIC SX 10 mcr	10"	10	2000	250	61	28
SA5706511	CPP 10 SANIC SX 25 mcr	10"	25	2000	250	61	28
SA5706514	CPP 10 SANIC SX 50 mcr	10"	50	2000	250	61	28
SA5706706	CPP 20 SANIC SX 1 mcr	20"	1	3000	505	61	28
SA5706708	CPP 20 SANIC SX 5 mcr	20"	5	3000	505	61	28
SA5706709	CPP 20 SANIC SX 10 mcr	20"	10	3000	505	61	28
SA5706711	CPP 20 SANIC SX 25 mcr	20"	25	3000	505	61	28
SA5706714	CPP 20 SANIC SX 50 mcr	20"	50	3000	505	61	28
SA5706806	CPP 30 SANIC SX 1 mcr	30"	1	4000	762	61	28
SA5706808	CPP 30 SANIC SX 5 mcr	30"	5	4000	762	61	28
SA5706809	CPP 30 SANIC SX 10 mcr	30"	10	4000	762	61	28
SA5706811	CPP 30 SANIC SX 25 mcr	30"	25	4000	762	61	28
SA5706814	CPP 30 SANIC SX 50 mcr	30"	50	4000	762	61	28
SA5708506	CPP 40 SANIC SX 1 mcr	40"	1	5000	1016	61	28
SA5708508	CPP 40 SANIC SX 5 mcr	40"	5	5000	1016	61	28
SA5708509	CPP 40 SANIC SX 10 mcr	40"	10	5000	1016	61	28
SA5708511	CPP 40 SANIC SX 25 mcr	40"	25	5000	1016	61	28
SA5708514	CPP 40 SANIC SX 50 mcr	40"	50	5000	1016	61	28
SA5709506	CPP 50 SANIC SX 1 mcr	50"	1	6000	1270	61	28
SA5709508	CPP 50 SANIC SX 5 mcr	50"	5	6000	1270	61	28
SA5709509	CPP 50 SANIC SX 10 mcr	50"	10	6000	1270	61	28
SA5709511	CPP 50 SANIC SX 25 mcr	50"	25	6000	1270	61	28
SA5709514	CPP 50 SANIC SX 50 mcr	50"	50	6000	1270	61	28

CPP SANIC are available in a variety of:

**CONFIGURATIONS:**

- SX standard configuration double open end (DOE) available for every height and diameter.
- BX proprietary configuration with double o-ring collar 45 mm, suitable to PLUS 3P BX housings, DP housings, K DP housings.

**MODELS:**

- CPP series from 4" to 50" OD 2.40" ID 1.10", SX, BX configurations.

**VARIANTS AVAILABLE ON MINIMUM QUANTITY:**

- CPP CX with double o-ring collar 57 mm, suitable to PLUS 3P CX, K DP housings.

**CERTIFICATIONS**



10" Sanic cartridges in combination with Sanic housings as complete systems are **tested and certified by IAPMO RT against NSF/ANSI 42 for bacteriostasis effect.** Components **tested and certified by IAPMO RT against NSF/ANSI Standards 42 and 61 for material and structural integrity requirements only.** In compliance with Drinking Water Treatment Units regulations, USA and Canada.



CPP SANIC cartridges are tested and certified under the most stringent procedures worldwide, **in compliance with DM 25 (Italy), with the sanitary certification ACS (France), EAC/Ghostreghistrizia (Russia) and WaterMark (Australia).**

Some items in the list are subject to minimum order quantities and/or to longer delivery term.

**Sediment filtration.**  
**Average life-span:** 6 months.  
**Maintenance:** none.

**WORKING CONDITIONS**

Max working temperature \_\_\_\_\_ 80°C (176°F)  
 Min working temperature \_\_\_\_\_ 4°C (39,2°F)

**SPECIFICATIONS**

Non-toxic materials, suitable for drinking water.  
 Filter medium: polypropylene with antimicrobial technology.  
 End caps: polypropylene.  
 O-rings: EPDM.

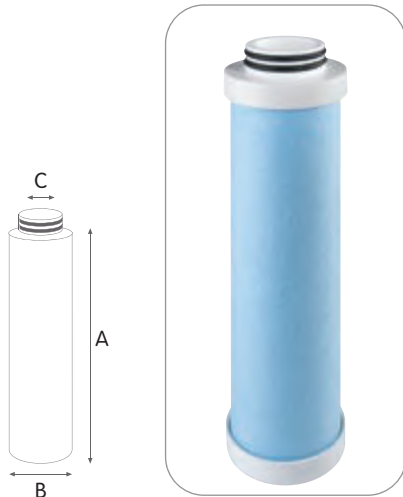

**CPP SANIC BX**

**POLYPROPYLENE MELT-BLOWN SMOOTH CARTRIDGES WITH DOUBLE O-RING COLLAR 45 MM**

CODE	MODEL	NOMINAL HEIGHT	NOMINAL FILTRATION MICRON	RECOMMENDED FLOW RATE l/h	DIMENSIONS MM		
					A	B	C
<b>OD 2,40" x ID 1,10"</b>							
SA5742206	CPP 5 SANIC BX 1 mcr	5"	1	1000	125	70	25
SA5742208	CPP 5 SANIC BX 5 mcr	5"	5	1000	125	70	25
SA5742209	CPP 5 SANIC BX 10 mcr	5"	10	1000	125	70	25
SA5742211	CPP 5 SANIC BX 25 mcr	5"	25	1000	125	70	25
SA5742214	CPP 5 SANIC BX 50 mcr	5"	50	1000	125	70	25
SA5744206	CPP 7 SANIC BX 1 mcr	7"	1	1400	173	70	25
SA5744208	CPP 7 SANIC BX 5 mcr	7"	5	1400	173	70	25
SA5744209	CPP 7 SANIC BX 10 mcr	7"	10	1400	173	70	25
SA5744211	CPP 7 SANIC BX 25 mcr	7"	25	1400	173	70	25
SA5744214	CPP 7 SANIC BX 50 mcr	7"	50	1400	173	70	25
SA5745206	CPP 10 SANIC BX 1 mcr	10"	1	2000	250	70	25
SA5745208	CPP 10 SANIC BX 5 mcr	10"	5	2000	250	70	25
SA5745209	CPP 10 SANIC BX 10 mcr	10"	10	2000	250	70	25
SA5745211	CPP 10 SANIC BX 25 mcr	10"	25	2000	250	70	25
SA5745214	CPP 10 SANIC BX 50 mcr	10"	50	2000	250	70	25
SA5747206	CPP 20 SANIC BX 1 mcr	20"	1	3000	505	70	25
SA5747208	CPP 20 SANIC BX 5 mcr	20"	5	3000	505	70	25
SA5747209	CPP 20 SANIC BX 10 mcr	20"	10	3000	505	70	25
SA5747211	CPP 20 SANIC BX 25 mcr	20"	25	3000	505	70	25
SA5747214	CPP 20 SANIC BX 50 mcr	20"	50	3000	505	70	25
SA5748206	CPP 30 SANIC BX 1 mcr	30"	1	4000	762	70	25
SA5748208	CPP 30 SANIC BX 5 mcr	30"	5	4000	762	70	25
SA5748209	CPP 30 SANIC BX 10 mcr	30"	10	4000	762	70	25
SA5748211	CPP 30 SANIC BX 25 mcr	30"	25	4000	762	70	25
SA5748214	CPP 30 SANIC BX 50 mcr	30"	50	4000	762	70	25
SA5749206	CPP 40 SANIC BX 1 mcr	40"	1	5000	1016	70	25
SA5749208	CPP 40 SANIC BX 5 mcr	40"	5	5000	1016	70	25
SA5749209	CPP 40 SANIC BX 10 mcr	40"	10	5000	1016	70	25
SA5749211	CPP 40 SANIC BX 25 mcr	40"	25	5000	1016	70	25
SA5749214	CPP 40 SANIC BX 50 mcr	40"	50	5000	1016	70	25

SEDIMENT CARTRIDGES

**FLOW RATE vs PRESSURE DROP Δp**

Tests carried on 10" elements type **CPP 10 SANIC SX**.  
 Testing mode: 20°C, 3 BAR

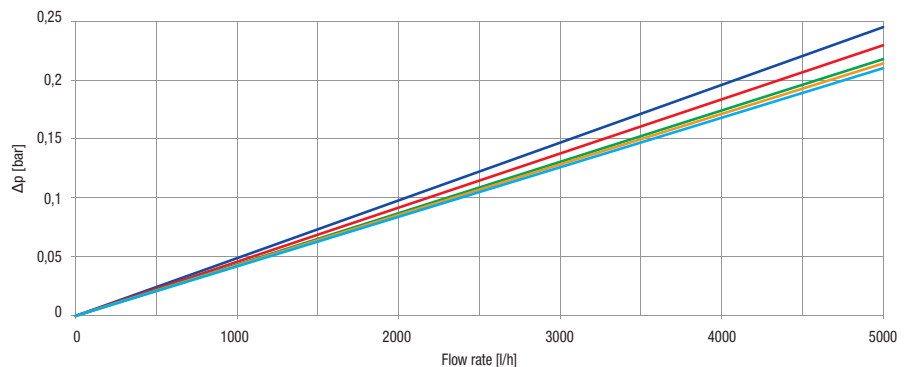

Some items in the list are subject to minimum order quantities and/or to longer delivery term.



# CPP BIG SANIC melt-blown polypropylene

**Sediment filtration.**  
**Average life-span:** 6 months.  
**Maintenance:** none.

**WORKING CONDITIONS**

Max working temperature \_\_\_\_\_ 80°C (176°F)  
 Min working temperature \_\_\_\_\_ 4°C (39,2°F)

**SPECIFICATIONS**

Non-toxic materials, suitable for drinking water.  
 Filter medium: polypropylene with antimicrobial technology.

A range of 4.50" OD melt-blown polypropylene cartridges with antimicrobial technology featuring a silver based antimicrobial agent are manufactured in specific plant which includes the standardization of production with dedicated software at every process' stage, thermal insulation at controlled temperature, full automation of the whole production line, from the raw-material loading to the finished product packing, without operator direct contact with the product, granting full hygienic safety. Certified raw materials, high productivity and quick delivery time, flexibility of production and custom made products complete the benefits of the range. CPP BIG SANIC cartridges height ranges at 10" and 20" are the most appropriate sediment filter cartridges for all drinking water applications.

## CPP BIG SANIC SX

**POLYPROPYLENE MELT-BLOWN SMOOTH CARTRIDGES WITH DOUBLE OPEN END (DOE)**

CODE	MODEL	NOMINAL HEIGHT	NOMINAL FILTRATION MICRON	RECOMMENDED FLOW RATE l/h	DIMENSIONS MM		
					A	B	C
<b>OD 4,50" x ID 1,10"</b>							
SA5706606	CPP 10 BIG SANIC SX 1 mcr	10"	1	2500	250	112	28
SA5706608	CPP 10 BIG SANIC SX 5 mcr	10"	5	2500	250	112	28
SA5706611	CPP 10 BIG SANIC SX 25 mcr	10"	25	2500	250	112	28
SA5706906	CPP 20 BIG SANIC SX 1 mcr	20"	1	4000	511	112	28
SA5706908	CPP 20 BIG SANIC SX 5 mcr	20"	5	4000	511	112	28
SA5706911	CPP 20 BIG SANIC SX 25 mcr	20"	25	4000	511	112	28

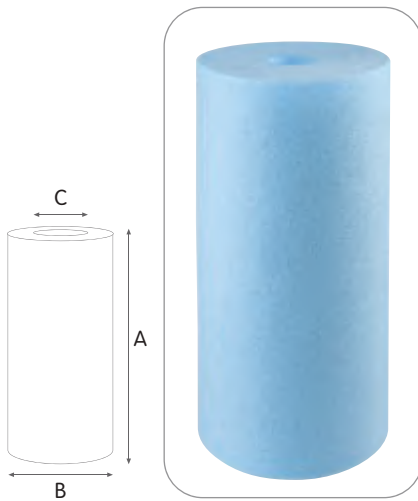

CPP BIG SANIC are available in a variety of:

**CONFIGURATIONS:**

- SX standard configuration double open end (DOE) available for every height and diameter.

**MODELS:**

- CPP BIG SANIC series 10" and 20", OD 4.50", ID 1.10". SX configuration

**CERTIFICATIONS**



10" Sanic cartridges in combination with Sanic housings as complete systems are **tested and certified by IAPMO RT against NSF/ANSI 42 for bacteriostasis effect.** Components **tested and certified by IAPMO RT against NSF/ANSI Standards 42 and 61 for material and structural integrity requirements only.** In compliance with Drinking Water Treatment Units regulations, USA and Canada.



CPP BIG SANIC cartridges are tested and certified under the most stringent procedures worldwide, **in compliance with DM 25 (Italy) and with the sanitary certification EAC/Ghostreghistrasia (Russia).**

**FLOW RATE vs PRESSURE DROP Δp**

Tests carried on 10" elements type **CPP 10 BIG SANIC SX.**  
 Testing mode: 20°C, 3 BAR

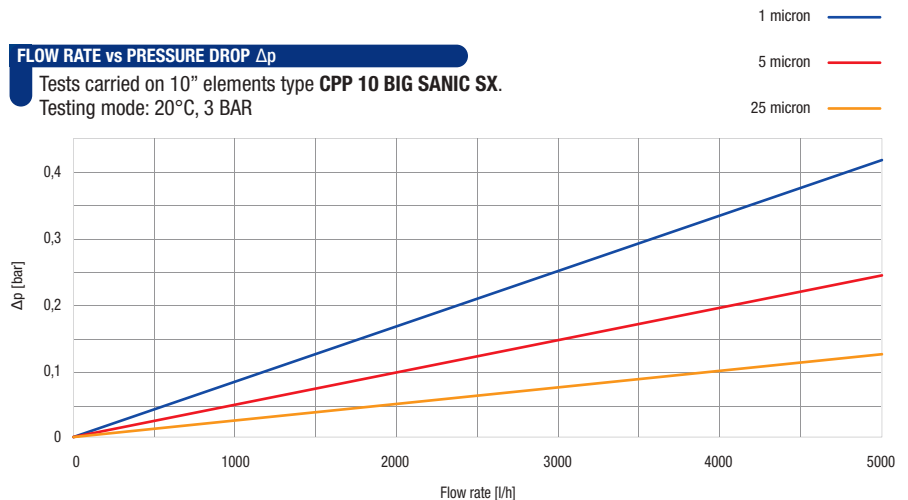





# WATER TREATMENT

filter cartridges

Extensive range of filter cartridges for every application in water treatment, made with the most appropriate treatment media



# CARTRIDGES CONFIGURATION

FOR FILTERS SX, BX, CX

Atlas Filtri® cartridges for water treatment are available in a wide range of end-caps configurations to provide:

- the widest compatibility to housings for cartridges with standard configuration SX with flat seals and double open end (DOE). The major part of housings in the market are suitable to this standard.
- a range of quick-fit double o-ring cartridges with proprietary configuration BX to ensure: perfect watertight fit, safer for micro-filtration, simple and rapid maintenance operations, perfect cartridge standing and elimination of wrong positioning, market exclusivity.



**SX** **Standard double open end (DOE) configuration with antimicrobial flat seals.**  
Fit to SX housings, DP housings, Depural®, Depural® Top, Bravo DP, Oasis DP.



**BX** **Quick-fit configuration with 45 mm double o-ring collar.**  
Fit to Plus 3P BX housings, DP housings, K DP housings, Depural® Top, Bravo DP, Oasis DP.

## WATER TREATMENT PRODUCTS BULK\*

### Polyphosphate crystals 10/20

- 0,5 Kg pack
- 1,5 Kg pack
- 25 kg drum

### Polyphosphate crystals 6/10

- 0,5 Kg pack
- 1,5 Kg pack
- 25 kg drum

### Granular activated carbon

- 0,3 kg pack
- 20 kg bag

### Strong cationic resin (softening)

- 25 litres bag

### Strong anionic resin (anti-nitrates)

- 25 litres bag

### Mixed bed resin (demineralisation)

- 25 litres bag

\* See page 321 for product reference

## TERMS LEGEND

### Filtration

Filter rate in micron.

### Flow rate

In liters per hour (l/h), the flow rate for ideal filtration using a new cartridge.

### Average life-span

The average working life of the cartridge. Working life depends on the type of application, and on the level of filtration, the cartridge material, the type of maintenance that can be carried out and, especially, depends on the quality of the water being treated. The quality of the water is an extremely variable factor and thus the average life-span is indicated for a mains water supply with average European potable water characteristics.

### Maintenance

Type and frequency of applicable maintenance operations.

## SYMBOLS LEGEND



For domestic use



For technical and industrial use



CB-EC cartridges are the only environmentally friendly carbon block element, made with a proprietary technology reducing green house gas emissions in activated carbon production.

## CARTRIDGES RANGE

### Cartridges for water treatment

#### GRANULAR ACTIVATED CARBON

Reduction of chlorine, taste, odour (CTO); volatile organic compounds (VOC) pesticides, insecticides, chlorinated organic compounds.

#### GRANULAR ACTIVATED CARBON

**LA** - granular activated carbon from coconut shell.

#### GRANULAR ACTIVATED CARBON AND FILTER MEDIUM

**FA-CA** - wound polypropylene thread. Filtration from 5 to 100 micron. Granular activated carbon from coconut shell.

**CA** - melt-blown polypropylene. Filtration 25 micron. Granular activated carbon from coconut shell.

**BT CPP LA** - melt-blown polypropylene. Filtration 5 and 25 micron. Granular activated carbon from coconut shell.

#### ACTIVATED CARBON BLOCK

Reduction of chlorine, taste, odour (CTO); volatile organic compounds (VOC) pesticides, insecticides, chlorinated organic compounds, heavy metals (Pb), bacteria and virus.

**CA SE** - activated carbon block from coconut shell. Filtration from 0,3 to 5 micron.

**CA-SE HF** - activated carbon block from coconut shell and hollow-fibre membranes. Filtration 0,15 and 0.02 micron. Antibacterial.

**CB-EC** - activated carbon block from coconut shell. Filtration from 1 to 10 micron.

#### POLYPHOSPHATE CRYSTALS

Anti-scale treatment

**HA** - polyphosphate crystals suitable for drinking water when used with Dosaprop proportional dosing systems.

**BT CPP HA** - melt-blown polypropylene. Filtration 5 and 25 micron. Polyphosphate crystals suitable for drinking water when used with Dosaprop proportional dosing systems.

**BT RL HA** - polyester net. Filtration 50 micron. Polyphosphate crystals suitable for drinking water when used with Dosaprop proportional dosing systems.

**FA HA** - wound polypropylene thread. Filtration from 5 to 100 micron. Polyphosphate crystals suitable for drinking water when used with Dosaprop proportional dosing systems.

**CPP HA** - melt-blown polypropylene. Filtration 5 and 25 micron. Polyphosphate crystals suitable for drinking water when used with Dosaprop proportional dosing systems.

#### IONIC EXCHANGE RESINS

**QA CF** - cationic resin. Reduction of total hardness.

**QA AF** - anionic resin. Reduction of nitrates.

**QA LM** - mixed bed of cationic and anionic resins. Demineralization.

#### EMPTY CONTAINERS

**P** - containers to be filled up with water treatment products.



# LA granular activated carbon (GAC)

**Reduction of:** chlorine, taste, odour (CTO); volatile organic compounds (VOC).  
**Average life-span:** 3 months.  
**Maintenance:** none.  
**Remark -** Use a pre-filter to protect the cartridge.

## WORKING CONDITIONS

Max working temperature \_\_\_\_\_ 45°C (113°F)  
 Min working temperature \_\_\_\_\_ 4°C (39,2°F)

## SPECIFICATIONS

Non-toxic materials, suitable for drinking water.  
 Container, end cap and grid: polystyrene.  
 Flat seal SX: SEBS with antimicrobial technology.  
 O-rings BX: EPDM.  
 Containing sponge: polyurethane.  
 Treatment material: granular activated carbon from coconut shell.

Plastic container filled with GAC, made from coconut shell for the reduction of chlorine, taste, odour (CTO) and volatile organic compounds (VOC), designed to provide the highest contact time of the water through the whole GAC bed. LA cartridges are available with height from 5" to 20".

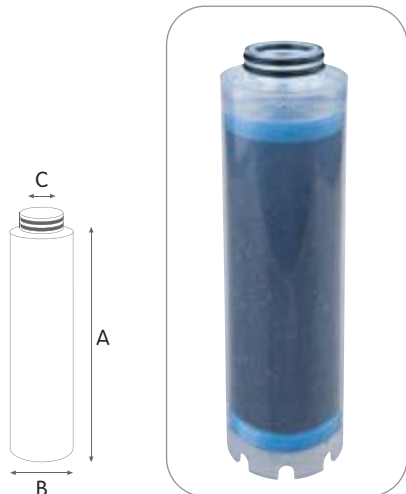
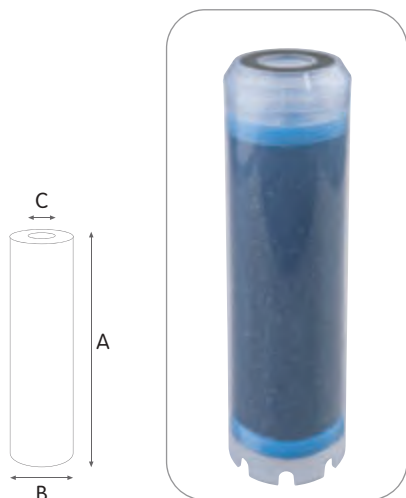

## LA SX

### GRANULAR ACTIVATED CARBON WITH DOUBLE OPEN END (DOE)

CODE	MODEL	NOMINAL HEIGHT	RECOMMENDED FLOW RATE l/h	DIMENSIONS MM		
				A	B	C
<b>OD 1,77" x ID 0,71"</b>						
RA5180125	LA MIGNON SX	5" M	150	125	50	21
<b>OD 2,40" x ID 1,10"</b>						
RA5182125	LA 5 SX	5"	200	128	70	28
RA5184125	LA 7 SX	7"	300	176	70	28
RA5185125	LA 10 SX	10"	500	252	70	28
RA5187125	LA 20 SX	20"	750	510	70	28

## LA BX

### GRANULAR ACTIVATED CARBON WITH DOUBLE O-RING COLLAR 45 MM

CODE	MODEL	NOMINAL HEIGHT	RECOMMENDED FLOW RATE l/h	DIMENSIONS MM		
				A	B	C
<b>OD 2,40" x ID 1,10"</b>						
RA5182225	LA 5 BX	5"	200	127	70	25
RA5184225	LA 7 BX	7"	300	183	70	25
RA5185225	LA 10 BX	10"	500	252	70	25
RA5187225	LA 20 BX	20"	750	510	70	25

LA cartridges are available in a variety of:

### CONFIGURATIONS:

- SX standard configuration double open end (DOE) available for every height and diameter.
- BX proprietary configuration with double o-ring collar 45 mm, suitable to PLUS 3P BX housings, DP housings, K DP housings.

### MODELS:

- LA MIGNON series 5" M OD 1.77" ID 0.71, SX configuration.
- LA series from 5" to 20" OD 2.40" ID 1.10", SX, BX configurations.

### VARIANTS AVAILABLE ON MINIMUM QUANTITY:

- LA-Ag models with silver impregnated coconut GAC for bacteriostatic effect.

### CERTIFICATIONS



LA cartridges are tested and certified under the most stringent procedures worldwide, in compliance with DM 25 (Italy), with the sanitary certification EAC/Ghostreghistrizia (Russia) and WaterMark (Australia).

### FLOW RATE vs PRESSURE DROP Δp

Tests carried on 10" elements type LA 10 SX.  
 Testing mode: 20°C, 3 BAR

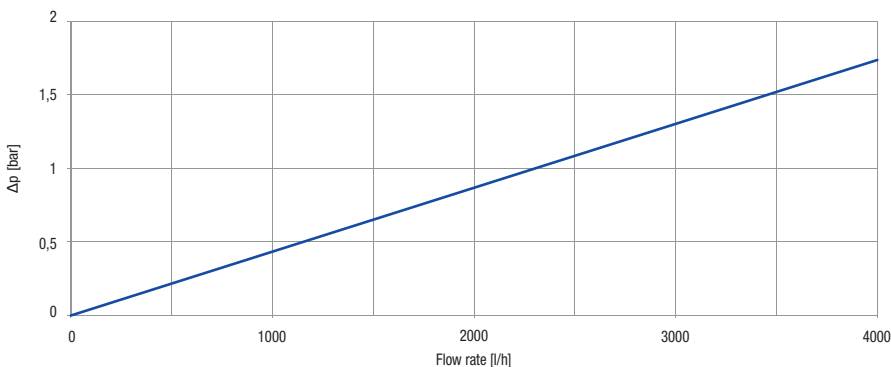



# FA CA wound polypropylene thread and granular activated carbon (GAC)

**Sediment filtration and reduction of:** chlorine, taste, odour (CTO); volatile organic compounds (VOC).  
**Average life-span:** 3 months.  
**Maintenance:** none.

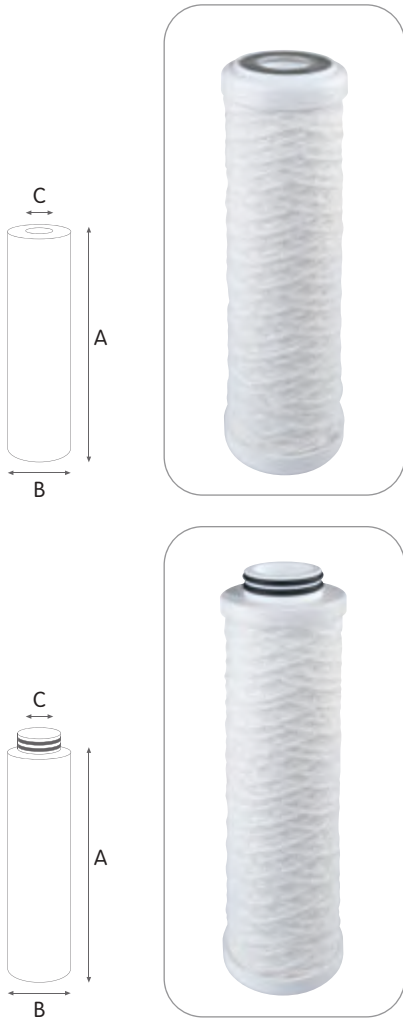

## WORKING CONDITIONS

Max working temperature \_\_\_\_\_ 45°C (113°F)  
Min working temperature \_\_\_\_\_ 4°C (39,2°F)

## SPECIFICATIONS

Non toxic materials, suitable for drinking water.  
Filtering medium: polypropylene.  
End caps and grids: polypropylene.  
Flat seals SX: SEBS with antimicrobial technology.  
O-rings BX: EPDM.  
Treatment material: granular activated carbon from coconut shell.

Wound polypropylene filter cartridge filled with GAC, made from coconut shell for the reduction of chlorine, taste, odour (CTO) and volatile organic compounds (VOC) providing pre-filtration at 5, 10, 25 and 50 micron. CA cartridges are available with height from 5" to 20".

## FA CA SX

### WOUND POLYPROPYLENE THREAD AND GRANULAR ACTIVATED CARBON WITH DOUBLE OPEN END (DOE)

CODE	MODEL	NOMINAL HEIGHT	NOMINAL FILTRATION MICRON	RECOMMENDED FLOW RATE l/h	DIMENSIONS MM		
					A	B	C
<b>OD 2,40" x ID 1,10"</b>							
RA5653108	FA 5 CA SX 5 mcr	5"	5	300	125	70	30
RA5653109	FA 5 CA SX 10 mcr	5"	10	300	125	70	30
RA5653111	FA 5 CA SX 25 mcr	5"	25	300	125	70	30
RA5653114	FA 5 CA SX 50 mcr	5"	50	300	125	70	30
RA5653119	FA 5 CA SX 100 mcr	5"	100	300	125	70	30
RA5654108	FA 7 CA SX 5 mcr	7"	5	450	173	70	30
RA5654109	FA 7 CA SX 10 mcr	7"	10	450	173	70	30
RA5654111	FA 7 CA SX 25 mcr	7"	25	450	173	70	30
RA5654114	FA 7 CA SX 50 mcr	7"	50	450	173	70	30
RA5654119	FA 7 CA SX 100 mcr	7"	100	450	173	70	30
RA5655108	FA 10 CA SX 5 mcr	10"	5	600	250	70	30
RA5655109	FA 10 CA SX 10 mcr	10"	10	600	250	70	30
RA5655111	FA 10 CA SX 25 mcr	10"	25	600	250	70	30
RA5655114	FA 10 CA SX 50 mcr	10"	50	600	250	70	30
RA5655119	FA 10 CA SX 100 mcr	10"	100	600	250	70	30

## FA CA BX

### WOUND POLYPROPYLENE THREAD AND GRANULAR ACTIVATED CARBON WITH DOUBLE O-RING COLLAR 45 MM

CODE	MODEL	NOMINAL HEIGHT	NOMINAL FILTRATION MICRON	RECOMMENDED FLOW RATE l/h	DIMENSIONS MM		
					A	B	C
<b>OD 2,40" x ID 1,10"</b>							
RA5653208	FA 5 CA BX 5 mcr	5"	5	300	125	70	30
RA5653209	FA 5 CA BX 10 mcr	5"	10	300	125	70	30
RA5653211	FA 5 CA BX 25 mcr	5"	25	300	125	70	30
RA5653214	FA 5 CA BX 50 mcr	5"	50	300	125	70	30
RA5653219	FA 5 CA BX 100 mcr	5"	100	300	125	70	30
RA5654208	FA 7 CA BX 5 mcr	7"	5	450	173	70	30
RA5654209	FA 7 CA BX 10 mcr	7"	10	450	173	70	30
RA5654211	FA 7 CA BX 25 mcr	7"	25	450	173	70	30
RA5654214	FA 7 CA BX 50 mcr	7"	50	450	173	70	30
RA5654219	FA 7 CA BX 100 mcr	7"	100	450	173	70	30
RA5655208	FA 10 CA BX 5 mcr	10"	5	600	250	70	30
RA5655209	FA 10 CA BX 10 mcr	10"	10	600	250	70	30
RA5655211	FA 10 CA BX 25 mcr	10"	25	600	250	70	30
RA5655214	FA 10 CA BX 50 mcr	10"	50	600	250	70	30
RA5655219	FA 10 CA BX 100 mcr	10"	100	600	250	70	30

FA-CA cartridges are available in a variety of:

### CONFIGURATIONS:

- SX standard configuration double open end (DOE) available for every height and diameter.
- BX proprietary configuration with double o-ring collar 45 mm, suitable to PLUS 3P BX housings, DP housings, K DP housings.

### MODELS:

- FA-CA series from 5" to 20" OD 2.40" ID 1.10", SX, BX configurations.

### VARIANTS AVAILABLE ON MINIMUM QUANTITY:

- FA-CA-Ag models with silver impregnated coconut GAC for bacteriostatic effect.

### CERTIFICATIONS



FA CA cartridges are tested and certified under the most stringent procedures worldwide, in compliance with DM 25 (Italy), with the sanitary certification EAC/Ghostreghistrizia (Russia) and WaterMark (Australia).

### FLOW RATE vs PRESSURE DROP $\Delta p$

Tests carried on 10" elements type FA CA 10 SX.  
Testing mode: 20°C, 3 BAR

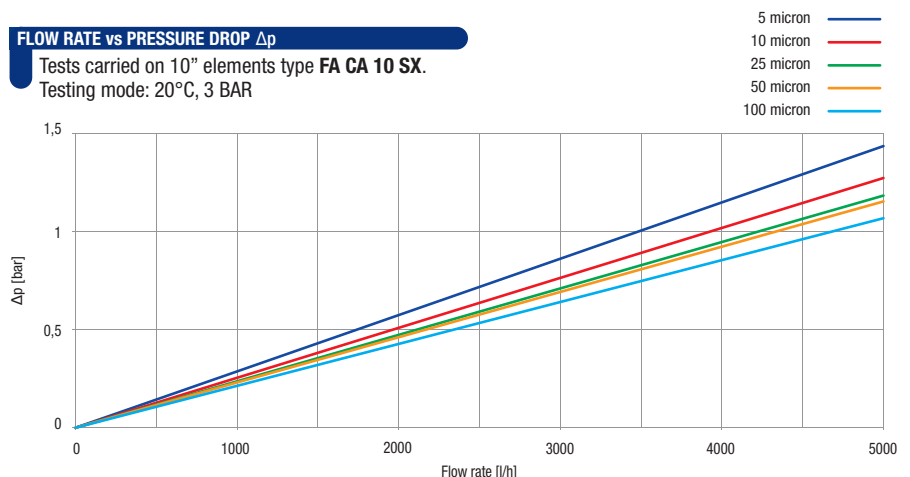

Some items in the list are subject to minimum order quantities and/or to longer delivery term.



# CA melt-blown polypropylene and granular activated carbon (GAC)

**Sediment filtration and reduction of:** chlorine, taste, odour (CTO); volatile organic compounds (VOC).  
**Average life-span:** 3 months.  
**Maintenance:** none.

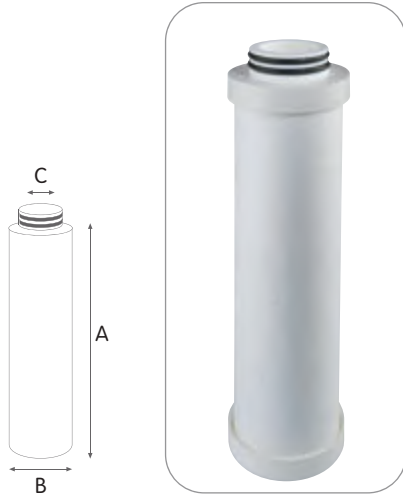
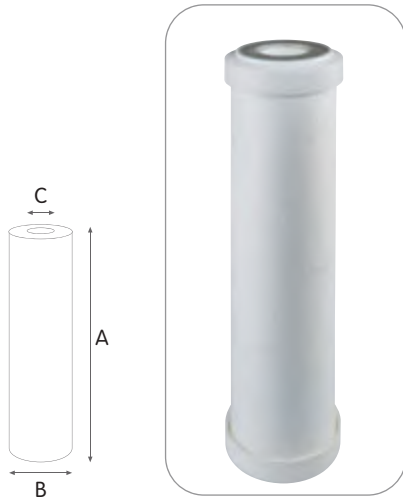

CA cartridges are available in a variety of:

### CONFIGURATIONS:

- SX standard configuration double open end (DOE) available for every height and diameter.
- BX proprietary configuration with double o-ring collar 45 mm, suitable to PLUS 3P BX housings, DP housings, K DP housings.

### MODELS:

- CA MIGNON series 5" M OD 1.77" ID 0.71", SX configuration.
- CA series from 5" to 20" OD 2.40" ID 1.10", SX, BX configurations.

### VARIANTS AVAILABLE ON MINIMUM QUANTITY:

- CA-Ag models with silver impregnated coconut GAC for bacteriostatic effect.
- Filter rates at 5, 10, 50 micron.

### CERTIFICATIONS



CA cartridges are tested and certified under the most stringent procedures worldwide, in compliance with DM 25 (Italy), with the sanitary certification EAC/Ghostreghistrizia (Russia) and WaterMark (Australia).

### WORKING CONDITIONS

Max working temperature \_\_\_\_\_ 45°C (113°F)  
Min working temperature \_\_\_\_\_ 4°C (39,2°F)

### SPECIFICATIONS

Non toxic materials, suitable for drinking water.  
Filter medium: polypropylene.  
End caps and grids: polypropylene.  
Flat seals SX: SEBS with antimicrobial technology.  
O-rings BX: EPDM.  
Treatment material: granular activated carbon from coconut shell.

Melt-blown polypropylene filter cartridge filled with GAC, made from coconut shell for the reduction of chlorine, taste, odour (CTO) and volatile organic compounds (VOC) providing pre-filtration at 25 micron. CA cartridges are available with height from 4" to 20".

## CA SX

### MELT BLOWN PP AND GRANULAR ACTIVATED CARBON WITH DOUBLE OPEN END (DOE)

CODE	MODEL	NOMINAL HEIGHT	NOMINAL FILTRATION MICRON	RECOMMENDED FLOW RATE l/h	DIMENSIONS MM		
					A	B	C
<b>OD 1,77" x ID 0,71"</b>							
RA5090111	CA MIGNON SX 25 mcr	5" M	25	150	106	50	18
<b>OD 2,40" x ID 1,10"</b>							
RA5091111	CA 4 SX 25 mcr	4"	25	200	101	70	30
RA5092111	CA 5 SX 25 mcr	5"	25	300	125	70	30
RA5094111	CA 7 SX 25 mcr	7"	25	450	173	70	30
RA5095111	CA 10 SX 25 mcr	10"	25	600	250	70	30
RA5097111	CA 20 SX 25 mcr	20"	25	1200	505	70	30

## CA BX

### MELT BLOWN PP AND GRANULAR ACTIVATED CARBON WITH DOUBLE O-RING COLLAR 45 MM

CODE	MODEL	NOMINAL HEIGHT	NOMINAL FILTRATION MICRON	RECOMMENDED FLOW RATE l/h	DIMENSIONS MM		
					A	B	C
<b>OD 2,40" x ID 1,10"</b>							
RA5092211	CA 5 BX 25 mcr	5"	25	300	125	70	30
RA5094211	CA 7 BX 25 mcr	7"	25	450	173	70	30
RA5095211	CA 10 BX 25 mcr	10"	25	600	250	70	30
RA5097211	CA 20 BX 25 mcr	20"	25	1200	505	70	30

### FLOW RATE vs PRESSURE DROP $\Delta p$

Tests carried on 10" elements type CA 10 SX.  
Testing mode: 20°C, 3 BAR

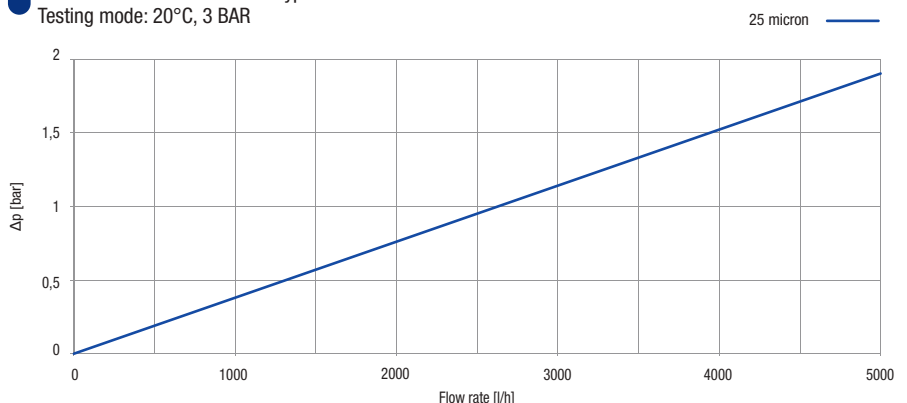

Some items in the list are subject to minimum order quantities and/or to longer delivery term.



# BT CPP LA melt-blown polypropylene and granular activated carbon (GAC)

**Sediment filtration and reduction of:** chlorine, taste, odour (CTO); volatile organic compounds (VOC).  
**Average life-span:** 3 months.  
**Maintenance:** none.

## WORKING CONDITIONS

Max working temperature  $\underline{\quad}$  45°C (113°F)  
 Min working temperature  $\underline{\quad}$  4°C (39,2°F)

## SPECIFICATIONS

Non-toxic materials, suitable for drinking water.  
 Filter medium: polypropylene.  
 Container, end cap and grid: polystyrene.  
 Flat seal SX: SEBS with antimicrobial technology.  
 O-rings BX: EPDM.  
 Treatment material: granular activated carbon from coconut shell.

Cartridges combining a pre-filter element made from melt-blown polypropylene and a plastic container filled with GAC, made from coconut shell, designed to provide fine sediment filtration at 5 and 25 micron and high contact time of the water through the whole GAC bed for the reduction of chlorine, taste, odour (CTO) and volatile organic compounds (VOC). BT CPP LA cartridges are available with height 10" and 20".

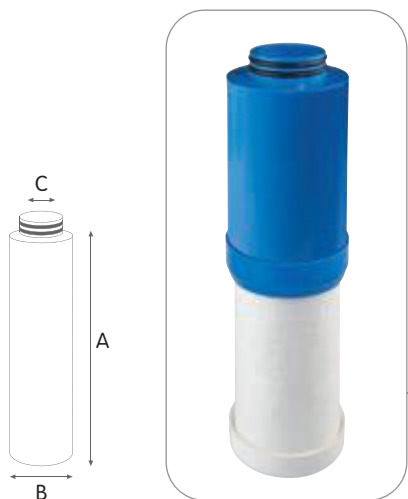
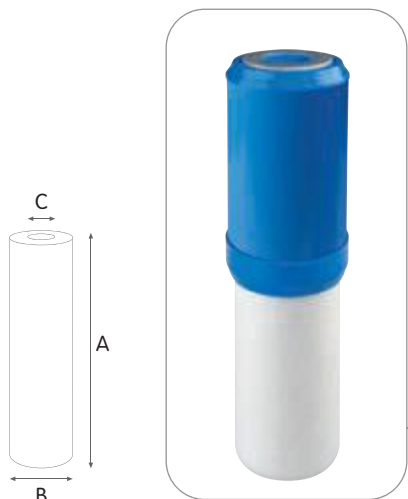

## BT CPP LA SX

### MELT BLOWN PP AND GRANULAR ACTIVATED CARBON WITH DOUBLE OPEN END (DOE)

CODE	MODEL	NOMINAL HEIGHT	NOMINAL FILTRATION MICRON	RECOMMENDED FLOW RATE l/h	DIMENSIONS MM		
					A	B	C
<b>OD 2,40" x ID 1,10"</b>							
RA5785308	BT CPP LA 10 SX AB 5 mcr	10"	5	500	252	72	28
RA5785311	BT CPP LA 10 SX AB 25 mcr	10"	25	500	252	72	28
RA5787308	BT CPP LA 20 SX AB 5 mcr	20"	5	750	510	72	28
RA5787311	BT CPP LA 20 SX AB 25 mcr	20"	25	750	510	72	28

## BT CPP LA BX

### MELT BLOWN PP AND GRANULAR ACTIVATED CARBON WITH DOUBLE O-RING COLLAR 45 MM

CODE	MODEL	NOMINAL HEIGHT	NOMINAL FILTRATION MICRON	RECOMMENDED FLOW RATE l/h	DIMENSIONS MM		
					A	B	C
<b>OD 2,40" x ID 1,10"</b>							
RA5785328	BT CPP LA 10 BX AB 5 mcr	10"	5	500	252	72	25
RA5785321	BT CPP LA 10 BX AB 25 mcr	10"	25	500	252	72	25
RA5787328	BT CPP LA 20 BX AB 5 mcr	20"	5	750	510	72	25
RA5787321	BT CPP LA 20 BX AB 25 mcr	20"	25	750	510	72	25

BT CPP LA cartridges are available in a variety of:

### CONFIGURATIONS:

- SX standard configuration double open end (DOE) available for every height and diameter.
- BX proprietary configuration with double o-ring collar 45 mm, suitable to PLUS 3P BX housings, DP housings, K DP housings.

### MODELS:

- BT CPP LA series 10" and 20" OD 2.40" ID 1.10", SX, BX configurations.

### VARIANTS AVAILABLE ON MINIMUM QUANTITY:

- BT CPP LA AG models with silver impregnated coconut GAC for bacteriostatic effect.

### CERTIFICATIONS



BT CPP LA cartridges are tested and certified under the most stringent procedures worldwide, in compliance with DM 25 (Italy), with the sanitary certification EAC/Ghostreghistracia (Russia) and WaterMark (Australia).

### FLOW RATE vs PRESSURE DROP $\Delta p$

Tests carried on 10" elements type BT CPP LA 10 SX.  
 Testing mode: 20°C, 3 BAR

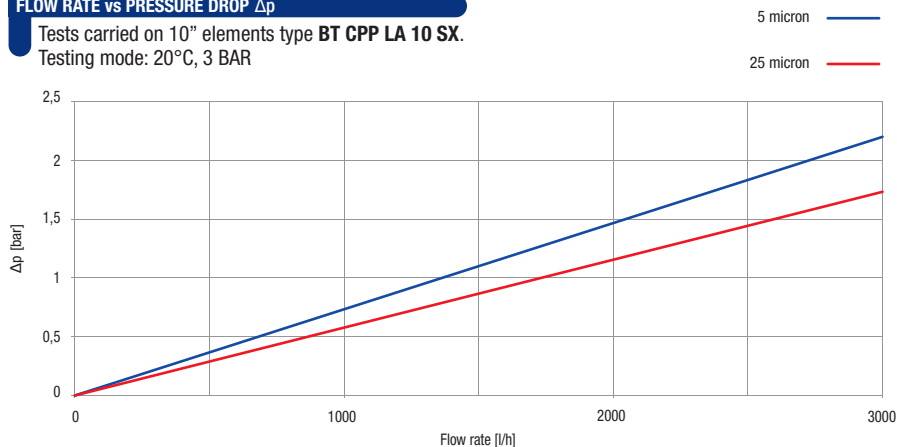



# CA SE SX carbon block

**Fine sediment filtration and reduction of:** chlorine, taste, odour (CTO); volatile organic compounds (VOC); heavy metals (Pb models).  
**Average life-span:** 3-6 months.  
**Maintenance:** none.

## WORKING CONDITIONS

Max working temperature      45°C (113°F)  
 Min working temperature      4°C (39,2°F)

## SPECIFICATIONS

Non-toxic materials, suitable for drinking water.  
 Filter and treatment medium: sintered block of activated carbon powder.  
 End caps: polypropylene.  
 Flat seals: SEBS with antimicrobial technology.

Activated carbon block made from coconut shell, providing fine sediment filtration and reduction of chlorine, taste, odour (CTO) and volatile organic compounds (VOC). Silver impregnated models for bacteriostatic effect with filtration at 0.3 micron. Pb models providing heavy metal reduction with filtration at 1 micron. Cartridges available from 4" to 10".

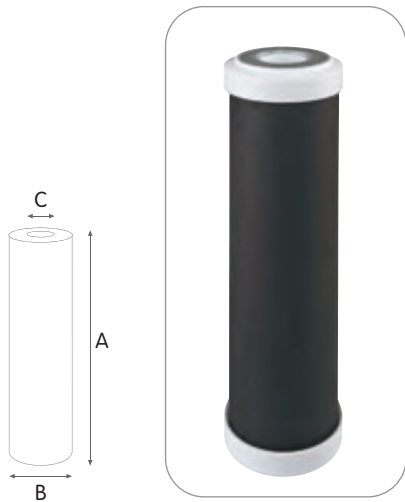

## CA SE SX

### CARBON BLOCK VOC WITH DOUBLE OPEN END (DOE)

CODE	MODEL	NOMINAL HEIGHT	NOMINAL FILTRATION MICRON	RECOMMENDED FLOW RATE l/h	DIMENSIONS MM		
					A	B	C
<b>OD 2,40" x ID 1,10"</b>							
RE5371108	CA 4 SE SX 5 mcr	4"	5	120	101	67	25
RE5372108	CA 5 SE SX 5 mcr	5"	5	150	124	67	25
RE5374108	CA 7 SE SX 5 mcr	7"	5	210	173	67	25
RE5375108	CA 10 SE SX 5 mcr	10"	5	300	248	67	25

### CARBON BLOCK SILVER IMPREGNATED WITH DOUBLE OPEN END (DOE)

CODE	MODEL	NOMINAL HEIGHT	NOMINAL FILTRATION MICRON	RECOMMENDED FLOW RATE l/h	DIMENSIONS MM		
					A	B	C
<b>OD 2,40" x ID 1,10"</b>							
RE5371100	CA 4 SE SX 0,3 mcr	4"	0,3	120	101	67	25
RE5372300	CA 5 SE SX 0,3 mcr	5"	0,3	150	124	67	25
RE5374500	CA 7 SE SX 0,3 mcr	7"	0,3	210	173	67	25
RE5375615	CA 10 SE SX 0,3 mcr	10"	0,3	300	248	67	25

### CARBON BLOCK Pb WITH DOUBLE OPEN END (DOE)

CODE	MODEL	NOMINAL HEIGHT	NOMINAL FILTRATION MICRON	RECOMMENDED FLOW RATE l/h	DIMENSIONS MM		
					A	B	C
<b>OD 2,40" x ID 1,10"</b>							
RE5371105	CA 4 SE Pb SX 0,5 mcr	4"	0,5	200	101	67	25
RE5372105	CA 5 SE Pb SX 0,5 mcr	5"	0,5	250	124	67	25
RE5374105	CA 7 SE Pb SX 0,5 mcr	7"	0,5	350	173	67	25
RE5375105	CA 10 SE Pb SX 0,5 mcr	10"	0,5	500	248	67	25

CA-SE SX cartridges are available in a variety of:

### CONFIGURATIONS:

- SX standard configuration double open end (DOE) available for every height and diameter.

### MODELS:

- CA-SE series from 4" to 10" OD 2.40" ID 1.10", SX configurations.

### VARIANTS AVAILABLE ON MINIMUM QUANTITY:

- CA-SE SX models 20".

### CERTIFICATIONS



CA SE SX cartridges are tested and certified under the most stringent procedures worldwide, in compliance with DM 25 (Italy), with the sanitary certification EAC/Ghostreghistrizia (Russia) and WaterMark (Australia).

### FLOW RATE vs PRESSURE DROP Δp

Tests carried on 10" elements type CA SE 10 SX.  
 Testing mode: 20°C, 3 BAR

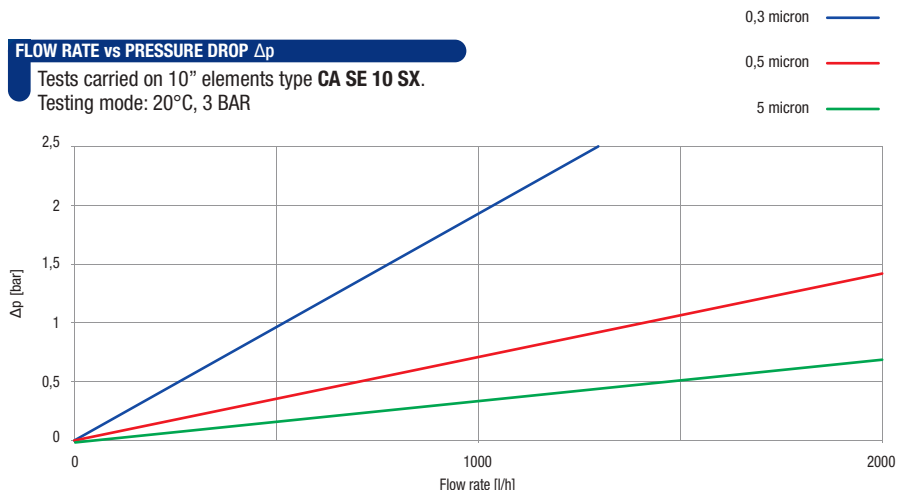

TREATMENT CARTRIDGES





# CA SE BX carbon block

**Fine sediment filtration and reduction of:** chlorine, taste, odour (CTO); volatile organic compounds (VOC); heavy metals (Pb models).  
**Average life-span:** 3-6 months.  
**Maintenance:** none.

## WORKING CONDITIONS

Max working temperature \_\_\_\_\_ 45°C (113°F)  
 Min working temperature \_\_\_\_\_ 4°C (39,2°F)

## SPECIFICATIONS

Non-toxic materials, suitable for drinking water.  
 Filter and treatment medium: sintered block of activated carbon powder.  
 End caps: polypropylene.  
 O-rings BX: EPDM.

Activated carbon block made from coconut shell, providing fine sediment filtration and reduction of chlorine, taste, odour (CTO) and volatile organic compounds (VOC). Silver impregnated models for bacteriostatic effect with filtration at 0.3 micron. Pb models providing heavy metal reduction with filtration at 1 micron. Cartridges available from 4" to 10".

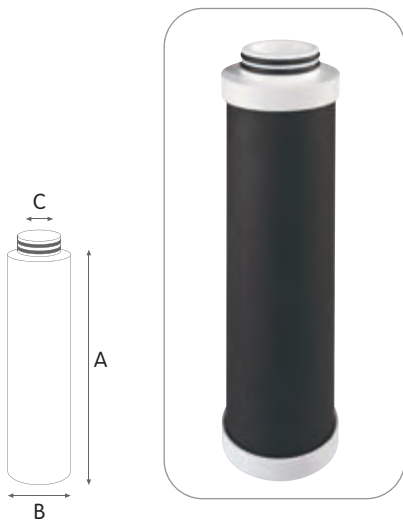

## CA SE BX

### CARBON BLOCK VOC WITH DOUBLE O-RING COLLAR 45 MM

CODE	MODEL	NOMINAL HEIGHT	NOMINAL FILTRATION MICRON	RECOMMENDED FLOW RATE l/h	DIMENSIONS MM		
					A	B	C
<b>OD 2,40" x ID 1,10"</b>							
RE5372208	CA 5 SE BX 5 mcr	5"	5	150	124	67	25
RE5374208	CA 7 SE BX 5 mcr	7"	5	210	173	67	25
RE5375208	CA 10 SE BX 5 mcr	10"	5	300	248	67	25

### CARBON BLOCK SILVER IMPREGNATED WITH DOUBLE O-RING COLLAR 45 MM

CODE	MODEL	NOMINAL HEIGHT	NOMINAL FILTRATION MICRON	RECOMMENDED FLOW RATE l/h	DIMENSIONS MM		
					A	B	C
<b>OD 2,40" x ID 1,10"</b>							
RE5372200	CA 5 SE BX 0,3 mcr	5"	0,3	150	124	67	25
RE5374200	CA 7 SE BX 0,3 mcr	7"	0,3	210	173	67	25
RE5375625	CA 10 SE BX 0,3 mcr	10"	0,3	300	248	67	25

### CARBON BLOCK Pb WITH DOUBLE O-RING COLLAR 45 MM

CODE	MODEL	NOMINAL HEIGHT	NOMINAL FILTRATION MICRON	RECOMMENDED FLOW RATE l/h	DIMENSIONS MM		
					A	B	C
<b>OD 2,40" x ID 1,10"</b>							
RE5372205	CA 5 SE Pb BX 0,5 mcr	5"	0,5	250	124	67	25
RE5374205	CA 7 SE Pb BX 0,5 mcr	7"	0,5	350	173	67	25
RE5375205	CA 10 SE Pb BX 0,5 mcr	10"	0,5	500	248	67	25

CA-SE BX cartridges are available in a variety of:

### CONFIGURATIONS:

- BX proprietary configuration with double o-ring collar 45 mm, suitable to PLUS 3P BX housings, DP housings, K DP housings.

### MODELS:

- CA-SE series from 5" to 10" OD 2.40" ID 1.10", BX configurations.

### VARIANTS AVAILABLE ON MINIMUM QUANTITY:

- CA-SE BX models 20".

### CERTIFICATIONS



CA SE BX cartridges are tested and certified under the most stringent procedures worldwide, in compliance with DM 25 (Italy), with the sanitary certification EAC/Ghostreghistrizia (Russia) and WaterMark (Australia).

### FLOW RATE vs PRESSURE DROP Δp

Tests carried on 10" elements type CA SE 10 BX.  
 Testing mode: 20°C, 3 BAR

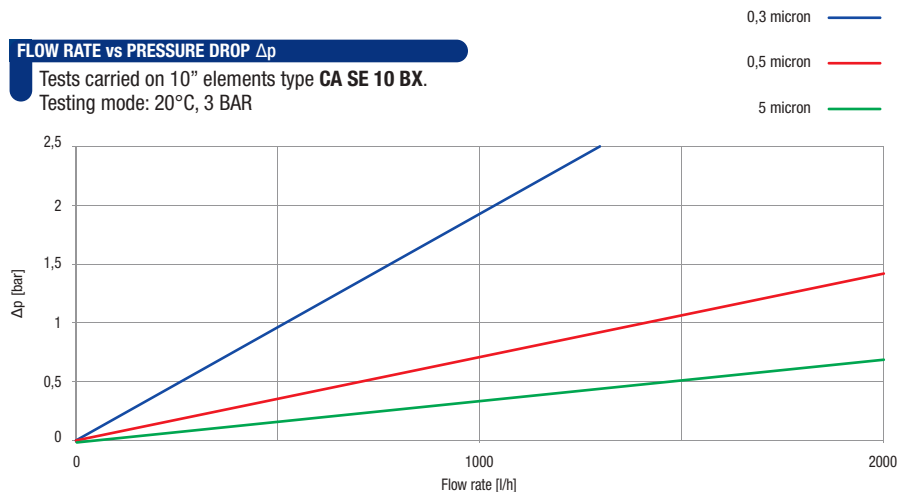



# CA-SE HF carbon block and hollow-fibre membranes

**Micro-filtration and Ultra-filtration of fine sediments, removal of microbes, reduction of:** chlorine, taste, odour (CTO); volatile organic compounds (VOC); heavy metals (Pb models).  
**Average life-span:** 3-6 months.  
**Maintenance:** none.  
**Remark -** Use a pre-filter to protect the cartridge.

## WORKING CONDITIONS

Max working temperature \_\_\_\_\_ 45°C (113°F)  
Min working temperature \_\_\_\_\_ 4°C (39,2°F)

## SPECIFICATIONS

Non-toxic materials, suitable for drinking water.  
Filter and treatment medium: sintered block of activated carbon powder.  
Micro and Ultra-filtration membranes: polyethersulphone (PES), HF tube high impact polystyrene (HIPS).  
End caps: polypropylene.  
O-rings BX: EPDM.

Activated carbon block made from coconut shell, providing fine sediment filtration and reduction of chlorine, taste, odour (CTO) and volatile organic compounds (VOC) provided with hollow-fibre membrane module for Micro-filtration at 0.15 micron or Ultra-filtration at 0.02 micron. CA-SE HF models at 0.15 micron remove the finest sediments and major part of harmful Bacteria (E. coli, Salmonella, V.cholerae, Legionella, Pseudomonas) and protozoan Cysts (Giardia, Cryptosporidium). CA-SE HF-U models at 0.02 micron remove Bacteria and Virus. All CA-SE HF models are available with height 10".

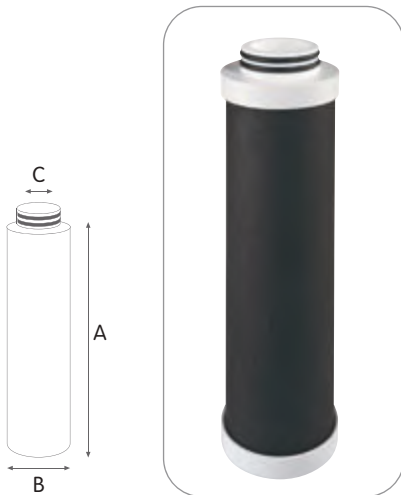

## CA-SE HF BX

### CARBON BLOCK WITH HOLLOW FIBRES WITH DOUBLE O-RING COLLAR 45 MM

CODE	MODEL	NOMINAL HEIGHT	NOMINAL FILTRATION MICRON	RECOMMENDED FLOW RATE l/h	DIMENSIONS MM		
					A	B	C
<b>OD 2,40" x ID 1,10"</b>							
RE5375530	CA-SE 10 HF-U BX 0,02 mcr	10"	0,02	100	248	67	25
RE5375520	CA-SE 10 HF BX 0,15 mcr	10"	0,15	400	248	67	25

## CA-SE HF Pb BX

### CARBON BLOCK WITH HOLLOW FIBRES WITH DOUBLE O-RING COLLAR 45 MM

CODE	MODEL	NOMINAL HEIGHT	NOMINAL FILTRATION MICRON	RECOMMENDED FLOW RATE l/h	DIMENSIONS MM		
					A	B	C
<b>OD 2,40" x ID 1,10"</b>							
RE5375550	CA-SE 10 HF-U Pb BX 0,02 mcr	10"	0,02	100	248	67	25
RE5375540	CA-SE 10 HF Pb BX 0,15 mcr	10"	0,15	400	248	67	25



The inner "Ster-O-Tap®" element (NSF 42 and 53 listed) with "hollow-fibre" capillary membranes is made in 2 models to provide Micro-filtration at 0.15 micron (tested against Brevimundimonas (Pseudomonas) diminuta) or Ultra-filtration at 0.02 micron. The hollow fibre membranes element is designed to provide a very large contact surface, resulting in high water flow and low pressure drop at stated filter rates.



CA-SE HF cartridges are available in a variety of:

### CONFIGURATIONS:

- BX proprietary configuration with double o-ring collar 45 mm, suitable to PLUS 3P BX housings, DP housings, K DP housings.

### MODELS:

- CA-SE HF series 10" to 10" OD 2.40" ID 1.10", BX configurations.

### CERTIFICATIONS



CA-SE HF cartridges are tested and certified under the most stringent procedures worldwide, in compliance with DM 25 (Italy), with the sanitary certification EAC/Ghostreghistrizia (Russia) and WaterMark (Australia).

### FLOW RATE vs PRESSURE DROP $\Delta p$

Tests carried on 10" elements type CA SE HF-U 10 SX.  
Testing mode: 20°C, 3 BAR

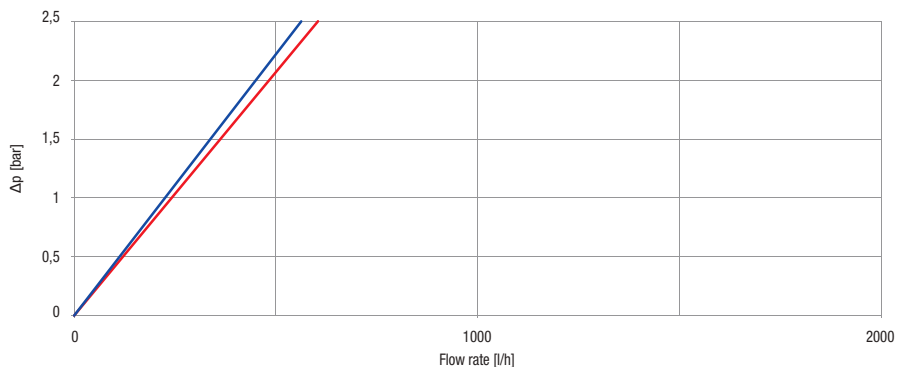



# CB-EC carbon block with outer protection sheet

**Fine sediment filtration and reduction of:** chlorine, taste, odour (CTO); volatile organic compounds (VOC); heavy metals (Pb models).  
**Average life-span:** 3-6 months.  
**Maintenance:** none.

## WORKING CONDITIONS

Max working temperature \_\_\_\_\_ 45°C (113°F)  
 Min working temperature \_\_\_\_\_ 4°C (39,2°F)

## SPECIFICATIONS

Non-toxic materials, suitable for drinking water.  
 Filter medium: sintered block made from coconut shell activated carbon powder.  
 End caps, netting and outer protection sheet: polypropylene.  
 Flat seals: NBR.

CB-EC are carbon block cartridges "environmentally friendly" manufactured, made with a proprietary technology reducing green-house gas emission in activated carbon production. Activated carbon block made from coconut shell, providing fine sediment filtration and reduction of chlorine, taste, odour (CTO), volatile organic compounds (VOC), heavy metal reduction (Pb) and filtration of protozoan (Giardia, Cryptosporidium) Cyst. CB-EC Cartridges are available from 5" to 20".

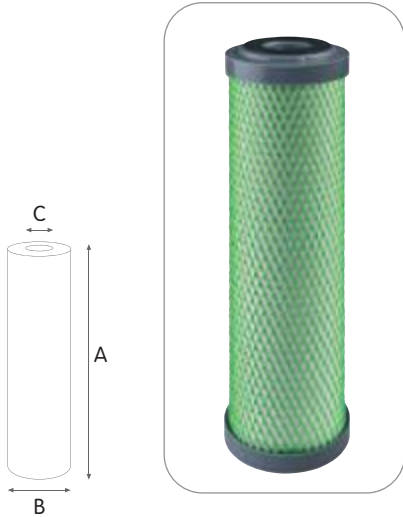
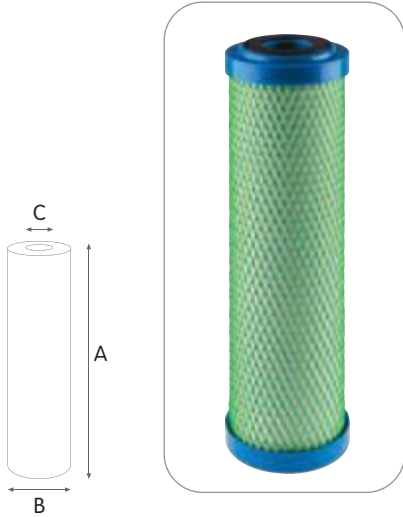

## CB-EC CYST SX

### CARBON BLOCK CYST WITH DOUBLE OPEN END (DOE)

CODE	MODEL	NOMINAL HEIGHT	NOMINAL FILTRATION MICRON	RECOMMENDED FLOW RATE l/h	DIMENSIONS MM		
					A	B	C
<b>OD 2,40" x ID 1,10"</b>							
RE5392106	CB-EC CYST 5 SX 1 mcr	5"	1	110	124	70	26
RE5394106	CB-EC CYST 7 SX 1 mcr	7"	1	160	173	70	26
RE5395106	CB-EC CYST 10 SX 1 mcr	10"	1	230	248	70	26
RE5397106	CB-EC CYST 20 SX 1 mcr	20"	1	450	504	70	26

## CB-EC Pb SX

### CARBON BLOCK Pb WITH DOUBLE OPEN END (DOE)

CODE	MODEL	NOMINAL HEIGHT	NOMINAL FILTRATION MICRON	RECOMMENDED FLOW RATE l/h	DIMENSIONS MM		
					A	B	C
<b>OD 2,40" x ID 1,10"</b>							
RE5392306	CB-EC Pb 5 SX 1 mcr	5"	1	110	124	70	26
RE5394306	CB-EC Pb 7 SX 1 mcr	7"	1	160	173	70	26
RE5395306	CB-EC Pb 10 SX 1 mcr	10"	1	230	248	70	26
RE5397306	CB-EC Pb 20 SX 1 mcr	20"	1	450	504	70	26

## CERTIFICATIONS



COMPONENT

CB-EC models are tested and certified by WQA according to NSF/ANSI Standard 42 for materials requirements only. Drinking water units. Aesthetic effect.

- CB-EC CYST 10 models are tested by WQA according to NSF 53 for Cyst reduction and Particulate Class I reduction as per NSF 42.
- CB-EC PB1 10 models are tested by WQA according to NSF 53 for Lead reduction.



EAC

CB EC cartridges are tested and certified under the most stringent procedures worldwide, **in compliance with DM 25 (Italy) and with the sanitary certification EAC (Russia).**

CB-EC cartridges are available in a variety of:

### CONFIGURATIONS:

- SX standard configuration double open end (DOE) available for every height and diameter.

### MODELS:

- CB-EC series from 5" to 20" OD 2.40" ID 1.10" SX configuration.

**Fine sediment filtration and reduction of:** chlorine, taste, odour (CTO); volatile organic compounds (VOC); heavy metals (Pb models).

**Average life-span:** 3-6 months.

**Maintenance:** none.

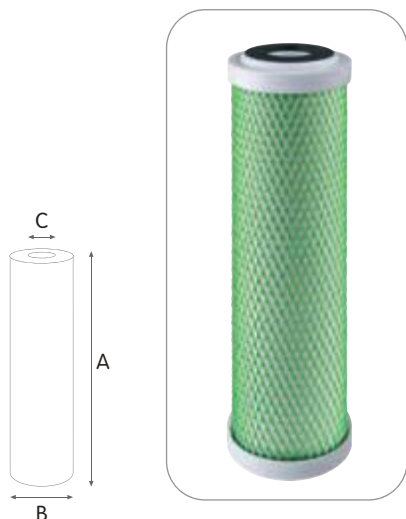
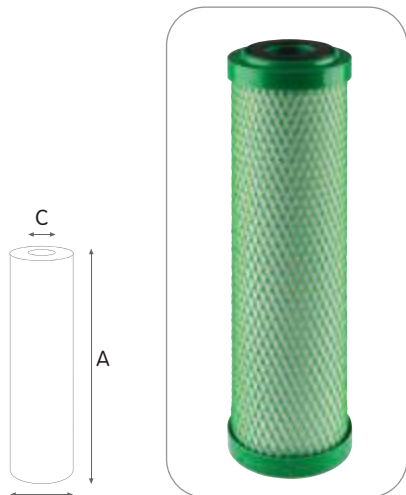

**CERTIFICATIONS**



COMPONENT

CB-EC models are tested and certified by WQA according to NSF/ANSI Standard 42 for materials requirements only. Drinking water units. Aesthetic effect.

- CB-EC 10 VOC models are tested by WQA according to NSF 53 for VOC reduction and Particulate Class II reduction as per NSF 42.

- CB-EC CTO 10 models are tested by WQA NSF 42 Aesthetic Chlorine reduction at 1 GPM and Particulate Class III reduction.



CB EC cartridges are tested and certified under the most stringent procedures worldwide, in compliance with DM 25 (Italy) and with the sanitary certification EAC (Russia).

**WORKING CONDITIONS**

Max working temperature \_\_\_\_\_ 45°C (113°F)

Min working temperature \_\_\_\_\_ 4°C (39,2°F)

**SPECIFICATIONS**

Non-toxic materials, suitable for drinking water.

Filter medium: sintered block made from coconut shell activated carbon powder.

End caps, netting and outer protection sheet: polypropylene.

Flat seals: NBR.

**CB-EC VOC SX**

**CARBON BLOCK VOC WITH DOUBLE OPEN END (DOE)**

CODE	MODEL	NOMINAL HEIGHT	NOMINAL FILTRATION MICRON	RECOMMENDED FLOW RATE l/h	DIMENSIONS MM		
		A	B	C			
<b>OD 2,40" x ID 1,10"</b>							
RE5392108	CB-EC VOC 5 SX 5 mcr	5"	5	110	124	70	26
RE5394108	CB-EC VOC 7 SX 5 mcr	7"	5	160	173	70	26
RE5395108	CB-EC VOC 10 SX 5 mcr	10"	5	230	248	70	26
RE5397108	CB-EC VOC 20 SX 5 mcr	20"	5	450	504	70	26

**CB-EC CTO SX**

**CARBON BLOCK CTO WITH DOUBLE OPEN END (DOE)**

CODE	MODEL	NOMINAL HEIGHT	NOMINAL FILTRATION MICRON	RECOMMENDED FLOW RATE l/h	DIMENSIONS MM		
		A	B	C			
<b>OD 2,40" x ID 1,10"</b>							
RE5392109	CB-EC CTO 5 SX 10 mcr	5"	10	110	124	70	26
RE5394109	CB-EC CTO 7 SX 10 mcr	7"	10	160	173	70	26
RE5395109	CB-EC CTO 10 SX 10 mcr	10"	10	230	248	70	26
RE5397109	CB-EC CTO 20 SX 10 mcr	20"	10	450	504	70	26

**FLOW RATE vs PRESSURE DROP Δp**

Tests carried on 10" elements type **CB-EC 10 SX**.

Testing mode: 20°C, 3 BAR

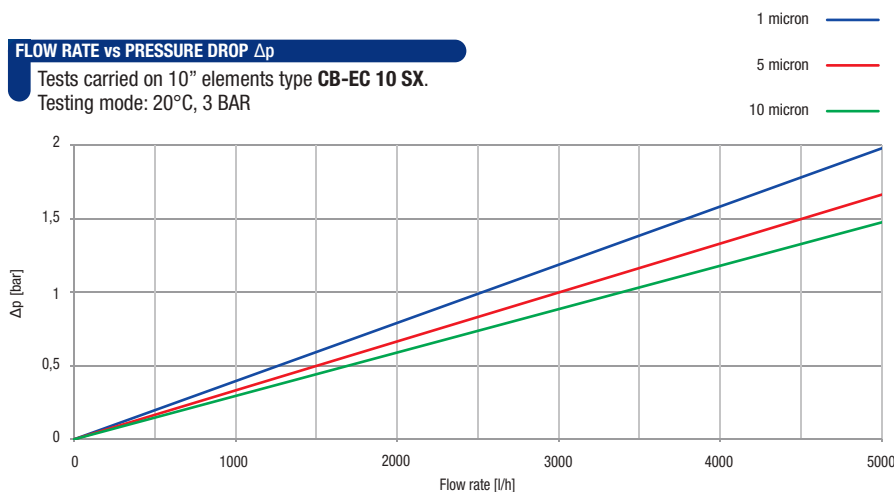

TREATMENT CARTRIDGES

# CB-EC BIG carbon block with outer protection sheet

**Fine sediment filtration and reduction of:** chlorine, taste, odour (CTO); volatile organic compounds (VOC); heavy metals (Pb models).  
**Average life-span:** 3-6 months.  
**Maintenance:** none.

## WORKING CONDITIONS

Max working temperature \_\_\_\_\_ 45°C (113°F)  
 Min working temperature \_\_\_\_\_ 4°C (39,2°F)

## SPECIFICATIONS

Non-toxic materials, suitable for drinking water.  
 Filter medium: sintered block made from coconut shell activated carbon powder.  
 End caps, netting and outer protection sheet: polypropylene.  
 Flat seals: NBR.

A range of 4.50" OD carbon block cartridges "environmentally friendly" manufactured, made with a proprietary technology reducing green-house gas emission in activated carbon production. Activated carbon block made from coconut shell, providing fine sediment filtration and reduction of chlorine, taste, odour (CTO), volatile organic compounds (VOC), heavy metal reduction (Pb) and filtration of protozoan (Giardia, Cryptosporidium) Cyst. CB-EC BIG cartridges are available at 10" and 20" heights.

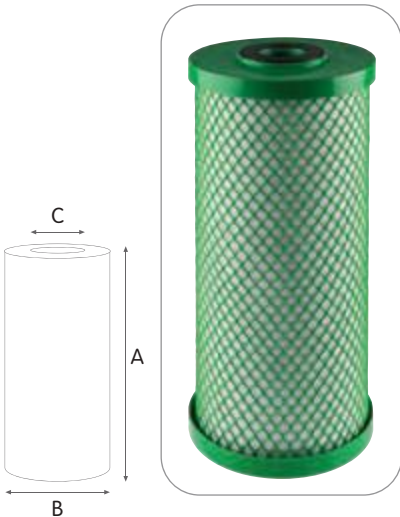

## CB-EC BIG SX

### CARBON BLOCK CYST WITH DOUBLE OPEN END (DOE)

CODE	MODEL	NOMINAL HEIGHT	NOMINAL FILTRATION MICRON	RECOMMENDED FLOW RATE l/h	DIMENSIONS MM		
					A	B	C
<b>OD 4,25" x ID 1,10"</b>							
RE5395506	CB-EC CYST 10 BIG 1 mcr	10"	1	680	250	114	26
RE5397506	CB-EC CYST 20 BIG 1 mcr	20"	1	1600	508	114	26

### CARBON BLOCK Pb WITH DOUBLE OPEN END (DOE)

CODE	MODEL	NOMINAL HEIGHT	NOMINAL FILTRATION MICRON	RECOMMENDED FLOW RATE l/h	DIMENSIONS MM		
					A	B	C
<b>OD 4,25" x ID 1,10"</b>							
RE5395606	CB-EC Pb 10 BIG SX 1 mcr	10"	1	680	250	114	26
RE5397606	CB-EC Pb 20 BIG SX 1 mcr	20"	1	1600	508	114	26

### CARBON BLOCK VOC WITH DOUBLE OPEN END (DOE)

CODE	MODEL	NOMINAL HEIGHT	NOMINAL FILTRATION MICRON	RECOMMENDED FLOW RATE l/h	DIMENSIONS MM		
					A	B	C
<b>OD 4,25" x ID 1,10"</b>							
RE5395508	CB-EC VOC 10 BIG 5 mcr	10"	5	680	250	114	26
RE5397508	CB-EC VOC 20 BIG 5 mcr	20"	5	1600	508	114	26

### CARBON BLOCK CTO WITH DOUBLE OPEN END (DOE)

CODE	MODEL	NOMINAL HEIGHT	NOMINAL FILTRATION MICRON	RECOMMENDED FLOW RATE l/h	DIMENSIONS MM		
					A	B	C
<b>OD 4,25" x ID 1,10"</b>							
RE5395509	CB-EC CTO 10 BIG 10 mcr	10"	10	680	250	114	26
RE5397509	CB-EC CTO 20 BIG 10 mcr	20"	10	1600	508	114	26

CB-EC BIG cartridges are available in a variety of:

### CONFIGURATIONS:

- SX standard configuration double open end (DOE) available for every height and diameter.

### MODELS:

- CB-EC BIG series 10" and 20" OD 4.50" ID 1.10" SX configuration.

### CERTIFICATIONS



COMPONENT

CB-EC BIG models are tested and certified by WQA according to NSF/ANSI Standard 42 for materials requirements only. Drinking water units. Aesthetic effect.



CB-EC BIG cartridges are tested and certified under the most stringent procedures worldwide, in compliance with DM 25 (Italy) and with the sanitary certification EAC (Russia).

### FLOW RATE vs PRESSURE DROP Δp

Tests carried on 10" elements type CB-EC BIG 10 SX.  
 Testing mode: 20°C, 3 BAR

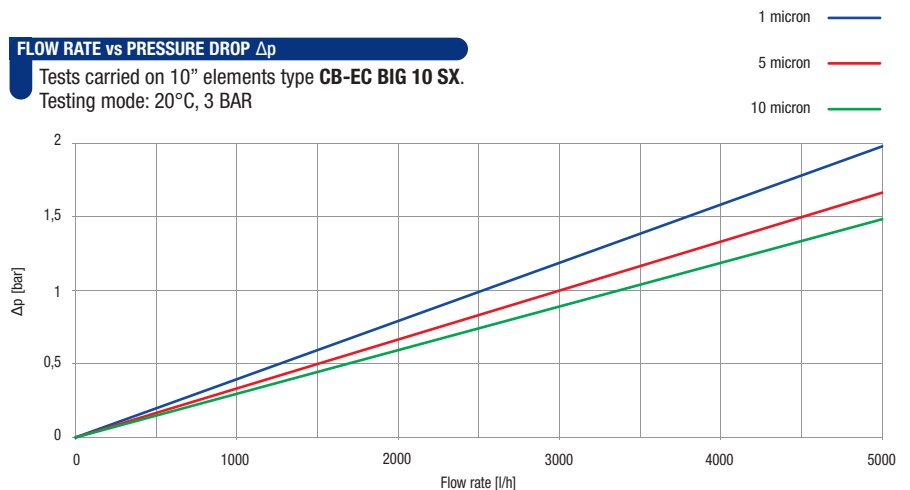

# HA polyphosphate crystals

**Anti-scale and anti-corrosion conditioning.**  
**Max life-span:** 6 months.  
**Maintenance:** none.  
**Remark** - Use a pre-filter to protect the cartridge.

## WORKING CONDITIONS

Max working temperature \_\_\_\_\_ 35°C (95°F)  
 Min working temperature \_\_\_\_\_ 4°C (39,2°F)  
 Max total hardness \_\_\_\_\_ 50°f (500 ppm CaCO<sub>3</sub>)  
**Remark** - the treated water can be heated up to 75°C - 80°C, above that temperature the polyphosphate loses gradually its effectiveness.

## SPECIFICATIONS

Non-toxic materials, suitable for drinking water.  
 Container, end cap and grid: polystyrene.  
 Flat seal SX: SEBS with antimicrobial technology.  
 O-rings BX: EPDM.  
 Treatment material: polyphosphate crystals

Plastic container filled with polyphosphate crystals for anti-scale water conditioning providing prevention form scale deposit and calcareous incrustation and protection from corrosion for water heaters, washing machines, pipes. The use with non-proportional dosing systems DOSAFOS is recommended for non-drinking purposes only. HA cartridges are available with height from 5" to 20".

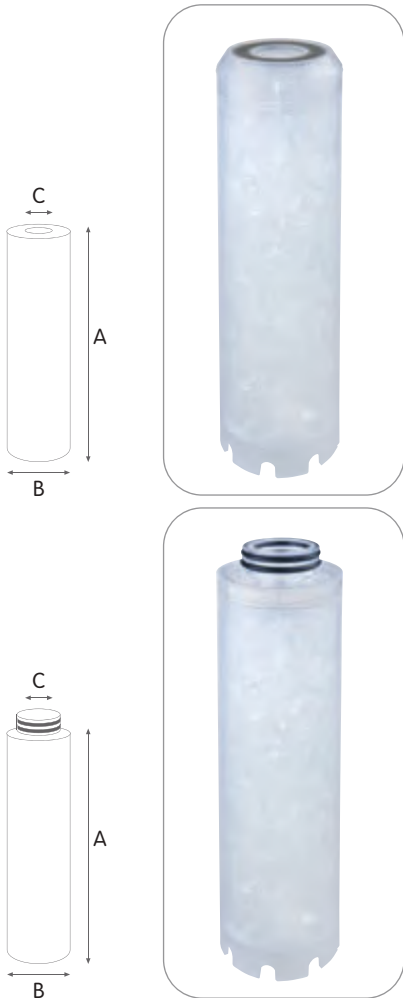

## HA SX

### POLIPHOSPHATE CARTRIDGES WITH DOUBLE OPEN END (DOE)

CODE	MODEL	NOMINAL HEIGHT	RECOMMENDED FLOW RATE l/h	DIMENSIONS MM		
				A	B	C
<b>OD 1,77" x ID 0,71"</b>						
RA5190125	HA MIGNON SX	5" M	500	125	50	21
<b>OD 2,40" x ID 1,10"</b>						
RA5192125	HA 5 SX TS	5"	800	128	70	28
RA5194125	HA 7 SX TS	7"	1000	176	70	28
RA5195125	HA 10 SX TS	10"	1500	252	70	28
RA5197125	HA 20 SX TS	20"	1800	510	70	28

## HA BX

### POLIPHOSPHATE CARTRIDGES WITH DOUBLE O-RING COLLAR 45 MM

CODE	MODEL	NOMINAL HEIGHT	RECOMMENDED FLOW RATE l/h	DIMENSIONS MM		
				A	B	C
<b>OD 2,40" x ID 1,10"</b>						
RA5192225	HA 5 BX	5"	800	127	70	25
RA5194225	HA 7 BX	7"	1000	183	70	25
RA5195225	HA 10 BX	10"	1500	252	70	25
RA5197225	HA 20 BX	20"	1800	510	70	25

HA cartridges are available in a variety of:

### CONFIGURATIONS:

- SX standard configuration double open end (DOE) available for every height and diameter.
- BX proprietary configuration with double o-ring collar 45 mm, suitable to PLUS 3P BX housings, DP housings, K DP housings.

### MODELS:

- HA MIGNON series 5"M OD 1.77" ID 0.71, SX configuration.
- HA series from 5" to 20" OD 2.40" ID 1.10", SX, BX configurations.

### CERTIFICATIONS



HA cartridges are tested and certified under the most stringent procedures worldwide, **in compliance with DM 25 (Italy), with the sanitary certification EAC/ Ghostreghistracia (Russia) and WaterMark (Australia).**

### FLOW RATE vs PRESSURE DROP Δp

Tests carried on 10" elements type **HA 10 SX**.  
 Testing mode: 20°C, 3 BAR

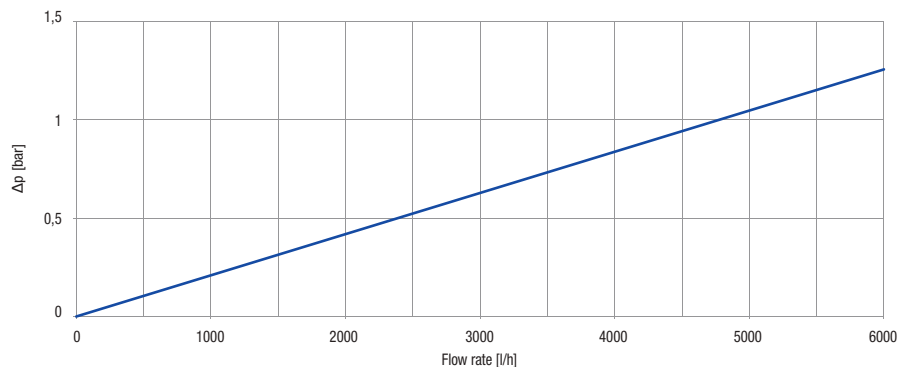





# BT CPP HA melt-blown polypropylene and polyphosphate crystals

**Sediment filtration, anti-scale and anti-corrosion conditioning.**  
**Max life-span:** 6 months.  
**Maintenance:** none.

## WORKING CONDITIONS

Max working temperature \_\_\_\_\_ 35°C (95°F)  
Min working temperature \_\_\_\_\_ 4°C (39,2°F)  
Max total hardness \_\_\_\_\_ 50°f (500 ppm CaCO<sub>3</sub>)  
**Remark** - the treated water can be heated up to 75°C - 80°C, above that temperature the polyphosphate loses gradually its effectiveness.

## SPECIFICATIONS

Non-toxic materials, suitable for drinking water.  
Filter medium: polypropylene.  
Container, end cap and grid: polystyrene.  
Flat seal SX: SEBS with antimicrobial technology.  
O-rings BX: EPDM.  
Treatment material: polyphosphate crystals

Cartridges combining a pre-filter element made from melt-blown polypropylene and a plastic container filled with polyphosphate crystals for anti-scale water conditioning providing fine sediment pre-filtration at 5 and 25 micron and high contact time of the water through the whole polyphosphate bed for the prevention from scale deposit and calcareous incrustation and protection from corrosion for water heaters, washing machines, pipes. BT CPP HA cartridges are available with height 10" and 20".

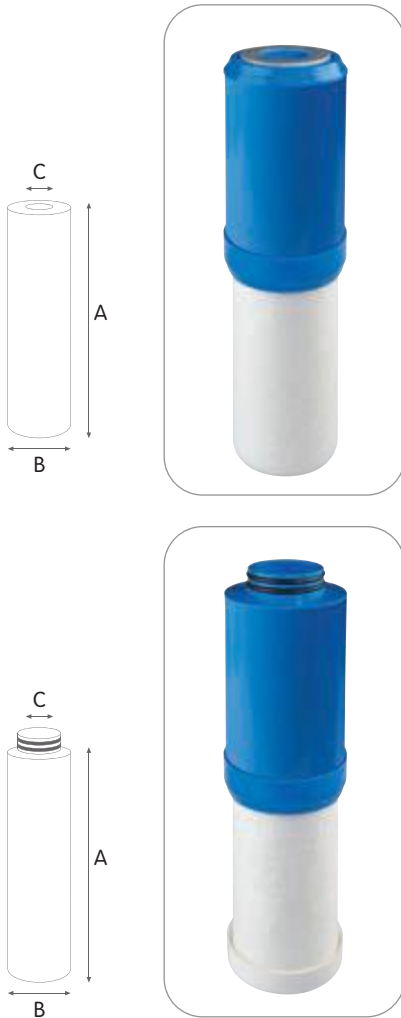

## BT CPP HA SX

### MELT BLOWN PP AND POLYPHOSPHATE CARTRIDGES WITH DOUBLE OPEN END (DOE)

CODE	MODEL	NOMINAL HEIGHT	NOMINAL FILTRATION MICRON	RECOMMENDED FLOW RATE l/h	DIMENSIONS MM		
					A	B	C
<b>OD 2,40" x ID 1,10"</b>							
RA5795308	BT CPP HA 10 SX AB 5 mcr	10"	5	1000	252	72	28
RA5795311	BT CPP HA 10 SX AB 25 mcr	10"	25	1000	252	72	28
RA5797308	BT CPP HA 20 SX AB 5 mcr	20"	5	1500	510	72	28
RA5797311	BT CPP HA 20 SX AB 25 mcr	20"	25	1500	510	72	28

## BT CPP HA BX

### MELT BLOWN PP AND POLYPHOSPHATE CARTRIDGES WITH DOUBLE O-RING COLLAR 45 MM

CODE	MODEL	NOMINAL HEIGHT	NOMINAL FILTRATION MICRON	RECOMMENDED FLOW RATE l/h	DIMENSIONS MM		
					A	B	C
<b>OD 2,40" x ID 1,10"</b>							
RA5795318	BT CPP HA 10 BX AB 5 mcr	10"	5	1000	252	72	25
RA5795321	BT CPP HA 10 BX AB 25 mcr	10"	25	1000	252	72	25
RA5797318	BT CPP HA 20 BX AB 5 mcr	20"	5	1500	510	72	25
RA5797321	BT CPP HA 20 BX AB 25 mcr	20"	25	1500	510	72	25

BT CPP HA cartridges are available in a variety of:

### CONFIGURATIONS:

- SX standard configuration double open end (DOE) available for every height and diameter.
- BX proprietary configuration with double o-ring collar 45 mm, suitable to PLUS 3P BX housings, DP housings, K DP housings.

### MODELS:

- BT CPP HA series 10" and 20" OD 2.40" ID 1.10", SX, BX configurations.

### CERTIFICATIONS



BT CPP HA cartridges are tested and certified under the most stringent procedures worldwide, in compliance with DM 25 (Italy), with the sanitary certification EAC/Ghostreghistrizia (Russia) and WaterMark (Australia).

### FLOW RATE vs PRESSURE DROP $\Delta p$

Tests carried on 10" elements type BT CPP HA 10 SX.  
Testing mode: 20°C, 3 BAR

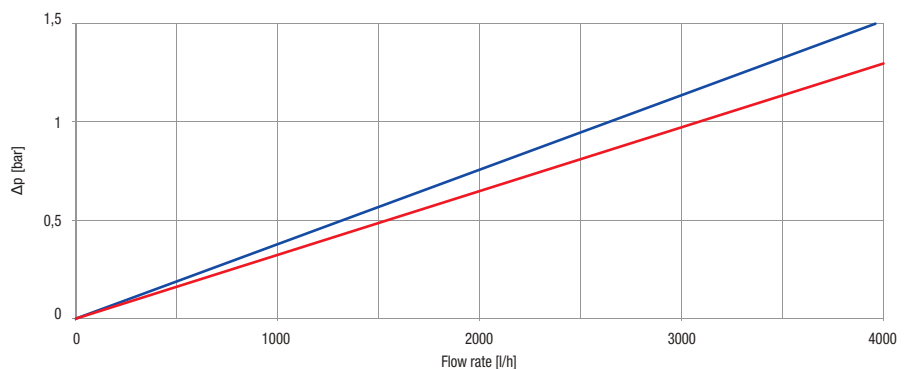



# BT RL HA polyester washable net and polyphosphate crystals

## Sediment filtration, anti-scale and anti-corrosion conditioning.

**Max life-span:** 6 months.

**Maintenance:** wash the net every month at least.

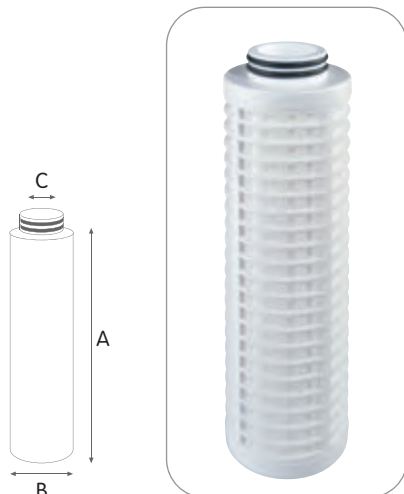
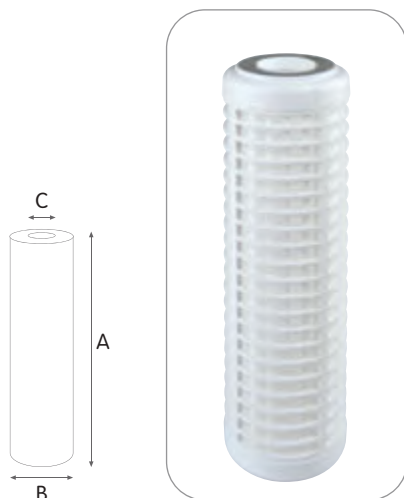

BT RL HA cartridges are available in a variety of:

### CONFIGURATIONS:

- SX standard configuration double open end (DOE) available for every height and diameter.
- BX proprietary configuration with double o-ring collar 45 mm, suitable to PLUS 3P BX housings, DP housings, K DP housings.

### MODELS:

- BT RL HA MIGNON series 5" M OD 1.77" ID 0.71, SX configuration.
- BT RL HA series 10" and 20" OD 2.40" ID 1.10", SX, BX configurations.

### VARIANTS AVAILABLE ON MINIMUM QUANTITY:

- BT RL C HA washable net filter with reduced outer frame for easier cleaning operations.
- BT RL A HA washable stainless steel net filter.

### CERTIFICATIONS



BT RL HA cartridges are tested and certified under the most stringent procedures worldwide, **in compliance with DM 25 (Italy), with the sanitary certification EAC/ Ghostreghistracia (Russia) and WaterMark (Australia).**

### WORKING CONDITIONS

Max working temperature \_\_\_\_\_ 35°C (95°F)

Min working temperature \_\_\_\_\_ 4°C (39,2°F)

Max total hardness \_\_\_\_\_ 50°F (500 ppm CaCO<sub>3</sub>)

**Remark** - the treated water can be heated up to 75°C - 80°C, above that temperature the polyphosphate loses gradually its effectiveness.

### SPECIFICATIONS

Non-toxic materials, suitable for drinking water.

Filter medium: polyester net.

Armouring and end caps: polypropylene.

Flat seals SX: SEBS with antimicrobial technology.

O-rings BX: EPDM.

Treatment material: polyphosphate crystals.

Cartridges combining a pre-filter element made with a washable net filter and polyphosphate crystals, designed to provide sediment filtration at 50 micron and anti-scale water conditioning, prevention from scale deposit, calcareous incrustation and protection from corrosion for water heaters, washing machines, pipes. BT RL HA cartridges are available with height 10" and 20".

## BT RL HA SX

### POLYESTER NET AND POLYPHOSPHATE CARTRIDGES WITH DOUBLE OPEN END (DOE)

CODE	MODEL	NOMINAL HEIGHT	NOMINAL FILTRATION MICRON	RECOMMENDED FLOW RATE l/h	DIMENSIONS MM		
					A	B	C
<b>OD 1,77" x ID 0,71"</b>							
RA5890114	BT RL MIGNON HA SX 50 mcr	5" M	50	500	122	50	20
<b>OD 2,40" x ID 1,10"</b>							
RA5892114	BT RL 5 HA SX 50 mcr	5"	50	800	125	70	30
RA5894114	BT RL 7 HA SX 50 mcr	7"	50	1000	173	70	30
RA5895114	BT RL 10 HA SX 50 mcr	10"	50	1500	250	70	30
RA5897114	BT RL 20 HA SX 50 mcr	20"	50	1800	505	70	30

## BT RL HA BX

### POLYESTER NET AND POLYPHOSPHATE CARTRIDGES WITH DOUBLE O-RING COLLAR 45 MM

CODE	MODEL	NOMINAL HEIGHT	NOMINAL FILTRATION MICRON	RECOMMENDED FLOW RATE l/h	DIMENSIONS MM		
					A	B	C
<b>OD 2,40" x ID 1,10"</b>							
RA5892214	BT RL 5 HA BX 50 mcr	5"	50	800	125	70	30
RA5894214	BT RL 7 HA BX 50 mcr	7"	50	1000	173	70	30
RA5895214	BT RL 10 HA BX 50 mcr	10"	50	1500	250	70	30
RA5897214	BT RL 20 HA BX 50 mcr	20"	50	1800	505	70	30

### FLOW RATE vs PRESSURE DROP $\Delta p$

Tests carried on 10" elements type **BT RL HA 10 SX**.

Testing mode: 20°C, 3 BAR

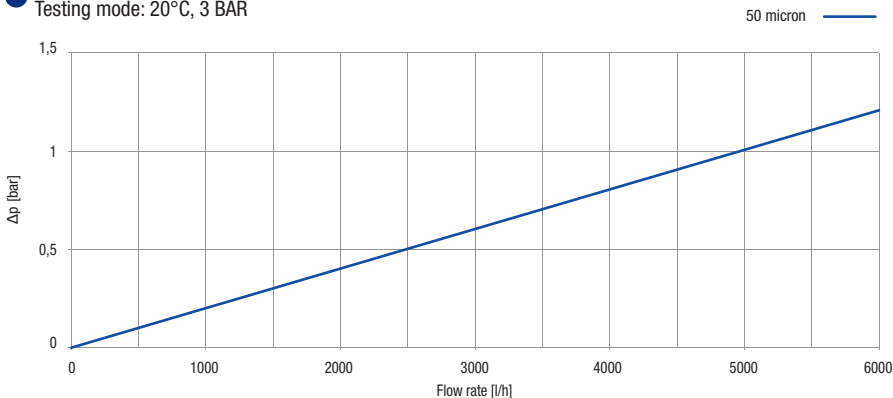



# FA HA wound polypropylene thread and polyphosphate crystals

**Sediment filtration, anti-scale and anti-corrosion conditioning.**

**Max life-span:** 6 months.

**Maintenance:** none.

## WORKING CONDITIONS

Max working temperature \_\_\_\_\_ 35°C (95°F)

Min working temperature \_\_\_\_\_ 4°C (39,2°F)

Max total hardness \_\_\_\_\_ 50°F (500 ppm CaCO<sub>3</sub>)

**Remark** - the treated water can be heated up to 75°C - 80°C, above that temperature the polyphosphate loses gradually its effectiveness.

## SPECIFICATIONS

Non-toxic materials, suitable for drinking water.

Filter medium: polypropylene.

Container, end cap and grid: polypropylene.

Flat seals SX: SEBS with antimicrobial technology.

O-rings BX: EPDM.

Treatment material: polyphosphate crystals.

Wound polypropylene filter cartridge filled with polyphosphate crystals, providing pre-filtration at 5, 10, 25, 50 and 100 micron and anti-scale water conditioning, prevention from scale deposit, calcareous incrustation and protection from corrosion for water heaters, washing machines, pipes. FA HA cartridges are available with height from 5" to 10".

## FA HA SX

### WOUND POLYPROPYLENE THREAD AND POLYPHOSPHATE CARTRIDGES WITH DOUBLE OPEN END (DOE)

CODE	MODEL	NOMINAL HEIGHT	NOMINAL FILTRATION MICRON	RECOMMENDED FLOW RATE l/h	DIMENSIONS MM		
					A	B	C
<b>OD 2,40" x ID 1,10"</b>							
RA5662108	FA 5 HA SX 5 mcr	5"	5	700	125	70	30
RA5662109	FA 5 HA SX 10 mcr	5"	10	700	125	70	30
RA5662111	FA 5 HA SX 25 mcr	5"	25	700	125	70	30
RA5662114	FA 5 HA SX 50 mcr	5"	50	700	125	70	30
RA5662119	FA 5 HA SX 100 mcr	5"	100	700	125	70	30
RA5664108	FA 7 HA SX 5 mcr	7"	5	900	173	70	30
RA5664109	FA 7 HA SX 10 mcr	7"	10	900	173	70	30
RA5664111	FA 7 HA SX 25 mcr	7"	25	900	173	70	30
RA5664114	FA 7 HA SX 50 mcr	7"	50	900	173	70	30
RA5664119	FA 7 HA SX 100 mcr	7"	100	900	173	70	30
RA5665108	FA 10 HA SX 5 mcr	10"	5	1300	250	70	30
RA5665109	FA 10 HA SX 10 mcr	10"	10	1300	250	70	30
RA5665111	FA 10 HA SX 25 mcr	10"	25	1300	250	70	30
RA5665114	FA 10 HA SX 50 mcr	10"	50	1300	250	70	30
RA5665119	FA 10 HA SX 100 mcr	10"	100	1300	250	70	30

## FA HA BX

### WOUND POLYPROPYLENE THREAD AND POLYPHOSPHATE CARTRIDGES WITH DOUBLE O-RING COLLAR 45 MM

CODE	MODEL	NOMINAL HEIGHT	NOMINAL FILTRATION MICRON	RECOMMENDED FLOW RATE l/h	DIMENSIONS MM		
					A	B	C
<b>OD 2,40" x ID 1,10"</b>							
RA5662208	FA 5 HA BX 5 mcr	5"	5	700	125	70	30
RA5662209	FA 5 HA BX 10 mcr	5"	10	700	125	70	30
RA5662211	FA 5 HA BX 25 mcr	5"	25	700	125	70	30
RA5662214	FA 5 HA BX 50 mcr	5"	50	700	125	70	30
RA5662219	FA 5 HA BX 100 mcr	5"	100	700	125	70	30
RA5664208	FA 7 HA BX 5 mcr	7"	5	900	173	70	30
RA5664209	FA 7 HA BX 10 mcr	7"	10	900	173	70	30
RA5664211	FA 7 HA BX 25 mcr	7"	25	900	173	70	30
RA5664214	FA 7 HA BX 50 mcr	7"	50	900	173	70	30
RA5664219	FA 7 HA BX 100 mcr	7"	100	900	173	70	30
RA5665208	FA 10 HA BX 5 mcr	10"	5	1300	250	70	30
RA5665209	FA 10 HA BX 10 mcr	10"	10	1300	250	70	30
RA5665211	FA 10 HA BX 25 mcr	10"	25	1300	250	70	30
RA5665214	FA 10 HA BX 50 mcr	10"	50	1300	250	70	30
RA5665219	FA 10 HA BX 100 mcr	10"	100	1300	250	70	30

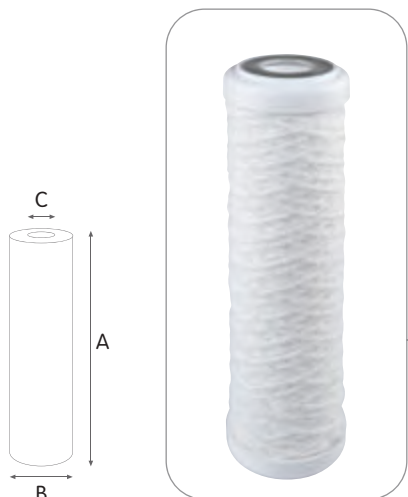

FA HA cartridges are available in a variety of:

### CONFIGURATIONS:

- SX standard configuration double open end (DOE) available for every height and diameter.
- BX proprietary configuration with double o-ring collar 45 mm, suitable to PLUS 3P BX housings, DP housings, K DP housings.

### MODELS:

- FA HA series from 5" to 10" OD 2.40" ID 1.10", SX, BX configurations.

### CERTIFICATIONS



FA HA cartridges are tested and certified under the most stringent procedures worldwide, in compliance with DM 25 (Italy), with the sanitary certification EAC/Ghostreghistrizia (Russia) and WaterMark (Australia).

### FLOW RATE vs PRESSURE DROP $\Delta p$

Tests carried on 10" elements type FA HA 10 SX.

Testing mode: 20°C, 3 BAR

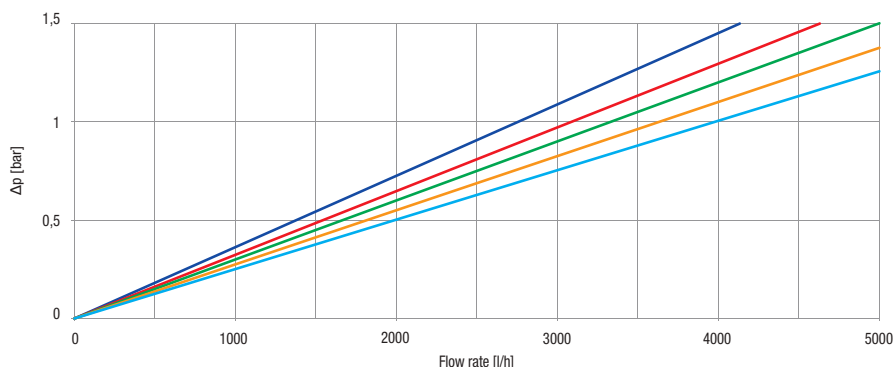

Some items in the list are subject to minimum order quantities and/or to longer delivery term.



# CPP HA melt-blown polypropylene and polyphosphate crystals

**Sediment filtration, anti-scale and anti-corrosion conditioning.**  
**Max life-span:** 6 months.  
**Maintenance:** none.

## WORKING CONDITIONS

Max working temperature \_\_\_\_\_ 35°C (95°F)  
Min working temperature \_\_\_\_\_ 4°C (39,2°F)  
Max total hardness \_\_\_\_\_ 50°f (500 ppm CaCO<sub>2</sub>)  
**Remark** - the treated water can be heated up to 75°C - 80°C, above that temperature the polyphosphate loses gradually its effectiveness.

## SPECIFICATIONS

Non-toxic materials, suitable for drinking water.  
Filter medium: polypropylene.  
End caps: polypropylene.  
Flat seals SX: SEBS with antimicrobial technology.  
O-rings BX: EPDM.  
Treatment material: polyphosphate crystals.

Melt-blown polypropylene filter cartridge filled with polyphosphate crystals for anti-scale water conditioning providing pre-filtration at 5 and 25 micron and prevention from scale deposit and calcareous incrustation and protection from corrosion for water heaters, washing machines, pipes. CPP HA cartridges are available with height from 5”M, 10” and 20”.

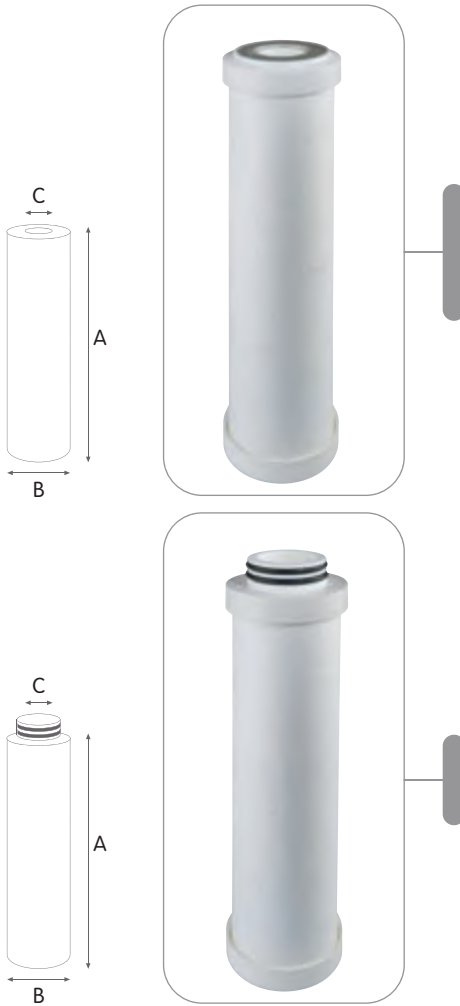

## CPP HA SX

### MELT BLOWN PP AND POLYPHOSPHATE CARTRIDGES WITH DOUBLE OPEN END (DOE)

CODE	MODEL	NOMINAL HEIGHT	NOMINAL FILTRATION MICRON	RECOMMENDED FLOW RATE l/h	DIMENSIONS MM		
					A	B	C
<b>OD 1,77" x ID 0,71"</b>							
RA5700008	CPP HA MIGNON SX 5 mcr	5" M	5	500	122	50	20
RA5700011	CPP HA MIGNON SX 25 mcr	5" M	25	500	122	50	20
<b>OD 2,40" x ID 1,10"</b>							
RA5775108	CPP HA 10 SX 5 mcr	10"	5	1300	250	70	25
RA5775111	CPP HA 10 SX 25 mcr	10"	25	1300	250	70	25
RA5777108	CPP HA 20 SX 5 mcr	20"	5	1600	505	70	25
RA5777111	CPP HA 20 SX 25 mcr	20"	25	1600	505	70	25

## CPP HA BX

### MELT BLOWN PP AND POLYPHOSPHATE CARTRIDGES WITH DOUBLE O-RING COLLAR 45 MM

CODE	MODEL	NOMINAL HEIGHT	NOMINAL FILTRATION MICRON	RECOMMENDED FLOW RATE l/h	DIMENSIONS MM		
					A	B	C
<b>OD 2,40" x ID 1,10"</b>							
RA5775208	CPP HA 10 BX 5 mcr	10"	5	1300	250	70	25
RA5775211	CPP HA 10 BX 25 mcr	10"	25	1300	250	70	25
RA5777208	CPP HA 20 BX 5 mcr	20"	5	1600	505	70	25
RA5777211	CPP HA 20 BX 25 mcr	20"	25	1600	505	67	25

CPP HA cartridges are available in a variety of:

### CONFIGURATIONS:

- SX standard configuration double open end (DOE) available for every height and diameter.
- BX proprietary configuration with double o-ring collar 45 mm, suitable to PLUS 3P BX housings, DP housings, K DP housings.

### MODELS:

- CPP HA MIGNON series 5”M OD 1.77” ID 0.71, SX configuration.
- CPP HA series 10” and 20” OD 2.40” ID 1.10”, SX, BX configurations.

### CERTIFICATIONS



CPP HA cartridges are tested and certified under the most stringent procedures worldwide, in compliance with DM 25 (Italy), with the sanitary certification EAC/Ghostreghistrizia (Russia) and WaterMark (Australia).

### FLOW RATE vs PRESSURE DROP Δp

Tests carried on 10” elements type **CPP HA 10 SX**.  
Testing mode: 20°C, 3 BAR

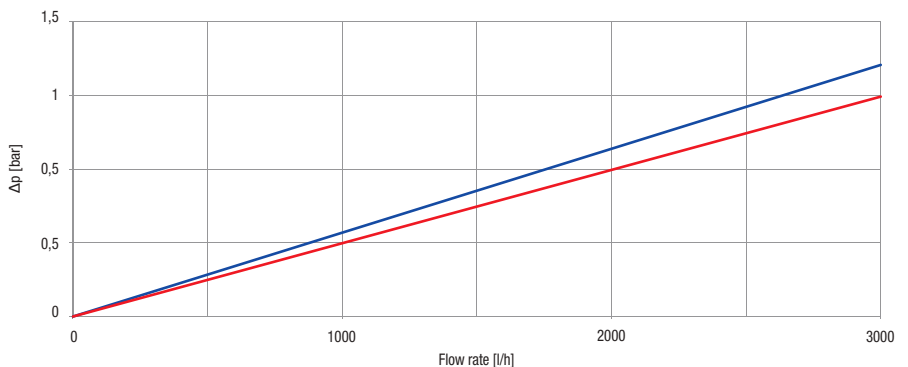

Some items in the list are subject to minimum order quantities and/or to longer delivery term.



# QA CF strong cationic resin

**Water softening.**

**Average life-span:** see the table below.

**Maintenance:** none.

**Remark** - Use a pre-filter to protect the cartridge.

**Note:** the cartridge does not change its colour when exhausted. Check the depletion of the resin with the specific Atlas Filtri EASY TEST strips.

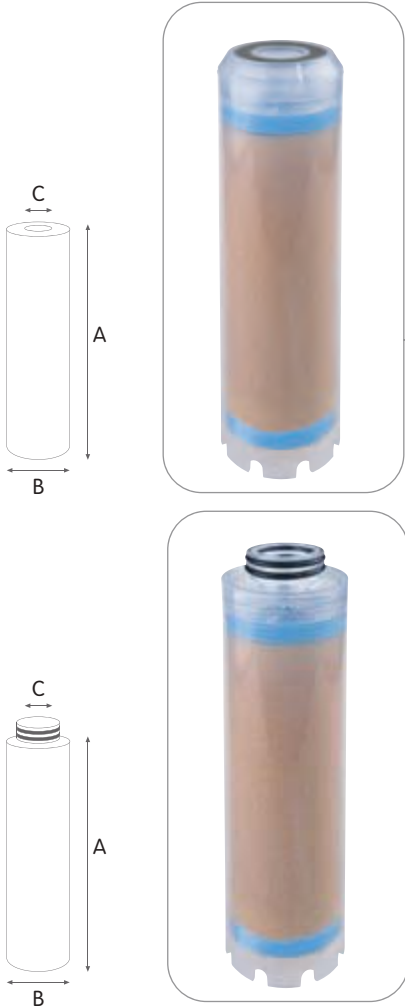

**WORKING CONDITIONS**

Max working temperature \_\_\_\_\_ 45°C (113°F)  
 Min working temperature \_\_\_\_\_ 4°C (39,2°F)  
 Max concentration Cl \_\_\_\_\_ 0,1 ppm  
 Max concentration Fe \_\_\_\_\_ 0,1 ppm

**SPECIFICATIONS**

Non-toxic materials, suitable for drinking water.  
 Container, end cap and grid: polystyrene.  
 Flat seal SX: SEBS with antimicrobial technology.  
 O-rings BX: EPDM.  
 Containing sponge: polyurethane.  
 Treatment material: strong cationic resin.

Plastic container filled with strong cationic-exchange resin, for the reduction of total hardness (TH) and providing water softening with removal of Calcium and Magnesium carbonates. QA-CF cartridges are available with height from 5" to 20".

**QA CF SX**

**CONTAINER WITH STRONG CATIONIC RESIN WITH DOUBLE OPEN END (DOE)**

CODE	MODEL	NOMINAL HEIGHT	RECOMMENDED FLOW RATE l/h	DIMENSIONS MM		
				A	B	C
<b>OD 2,40" x ID 1,10"</b>						
RA5202125	QA 5 CF SX	5"	25	128	70	28
RA5204125	QA 7 CF SX	7"	30	176	70	28
RA5205125	QA 10 CF SX	10"	50	252	70	28
RA5207125	QA 20 CF SX	20"	90	510	70	28

**QA CF BX**

**CONTAINER WITH STRONG CATIONIC RESIN WITH DOUBLE O-RING COLLAR 45 MM**

CODE	MODEL	NOMINAL HEIGHT	RECOMMENDED FLOW RATE l/h	DIMENSIONS MM		
				A	B	C
<b>OD 2,40" x ID 1,10"</b>						
RA5202225	QA 5 CF BX	5"	25	127	70	25
RA5204225	QA 7 CF BX	7"	30	183	70	25
RA5205225	QA 10 CF BX	10"	50	252	70	25
RA5207225	QA 20 CF BX	20"	90	510	70	25

10" cartridge duration in litres starting from a given water intake carbonates concentration (as CaCO<sub>3</sub> ppm)

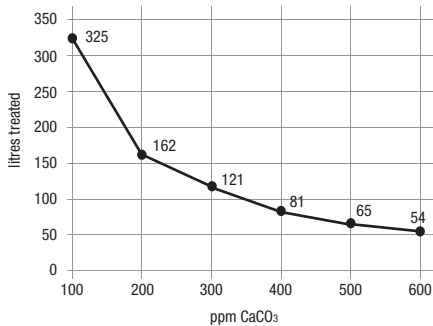

**CERTIFICATIONS**



QA CF cartridges are tested and certified under the most stringent procedures worldwide, in compliance with DM 25 (Italy), with the sanitary certification EAC/Ghostreghistracia (Russia) and WaterMark (Australia).

QA-CF cartridges are available in a variety of:

**CONFIGURATIONS:**

- SX standard configuration double open end (DOE) available for every height and diameter.
- BX proprietary configuration with double o-ring collar 45 mm, suitable to PLUS 3P BX housings, DP housings, K DP housings.

**MODELS:**

- QA-CF series from 5" to 20" OD 2.40" ID 1.10", SX, BX configurations.

**FLOW RATE vs PRESSURE DROP Δp**

Tests carried on 10" elements type QA CF 10 SX.  
 Testing mode: 20°C, 3 BAR

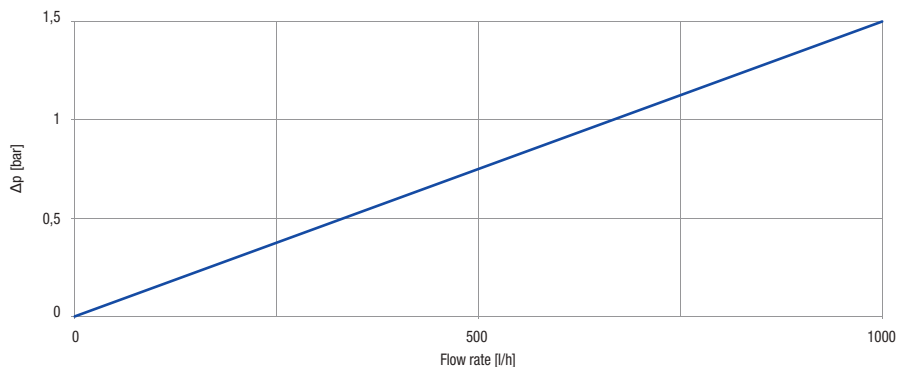



# QA AF anionic resin nitrates selective

**Reduction of nitrates.**  
**Average life-span:** see the table below.  
**Maintenance:** none.  
**Remark -** Use a pre-filter to protect the cartridge.

## WORKING CONDITIONS

Max working temperature \_\_\_\_\_ 45°C (113°F)  
 Min working temperature \_\_\_\_\_ 4°C (39,2°F)  
 Max concentration NaNO<sub>3</sub> \_\_\_\_\_ 200 ppm  
 Max concentration SO<sub>4</sub> \_\_\_\_\_ 200-300 ppm

## SPECIFICATIONS

Non-toxic materials, suitable for drinking water.  
 Container, end cap and grid: polystyrene.  
 Flat seal SX: SEBS with antimicrobial technology.  
 O-rings BX: EPDM.  
 Containing sponge: polyurethane.  
 Treatment material: strong anionic resin nitrates-selective.

Plastic container filled with anti-nitrate selective ionic-exchange resin, for the reduction of nitrate content in drinking water. The concentration of nitrates in drinking water below 50 mg/l is strongly recommended by World Health Organization (WHO) guidelines. QA-AF cartridges are available with height from 5" to 20".

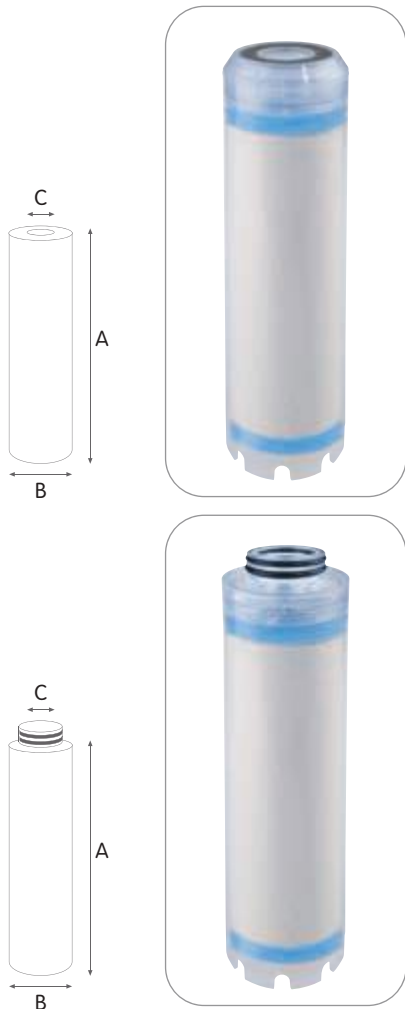

## QA AF SX

### CONTAINER WITH ANIONIC RESIN WITH DOUBLE OPEN END (DOE)

CODE	MODEL	NOMINAL HEIGHT	RECOMMENDED FLOW RATE l/h	DIMENSIONS MM		
				A	B	C
<b>OD 2,40" x ID 1,10"</b>						
RA5352125	QA 5 AF SX	5"	25	128	70	28
RA5354125	QA 7 AF SX	7"	35	176	70	28
RA5355125	QA 10 AF SX	10"	50	252	70	28
RA5357125	QA 20 AF SX	20"	90	510	70	28

## QA AF BX

### CONTAINER WITH ANIONIC RESIN WITH DOUBLE O-RING COLLAR 45 MM

CODE	MODEL	NOMINAL HEIGHT	RECOMMENDED FLOW RATE l/h	DIMENSIONS MM		
				A	B	C
<b>OD 2,40" x ID 1,10"</b>						
RA5352225	QA 5 AF BX	5"	25	127	70	25
RA5354225	QA 7 AF BX	7"	35	183	70	25
RA5355225	QA 10 AF BX	10"	50	252	70	25
RA5357225	QA 20 AF BX	20"	90	510	70	25

10" cartridge duration in litres starting from a given water intake carbonates concentration (as NaNO<sub>3</sub> ppm)

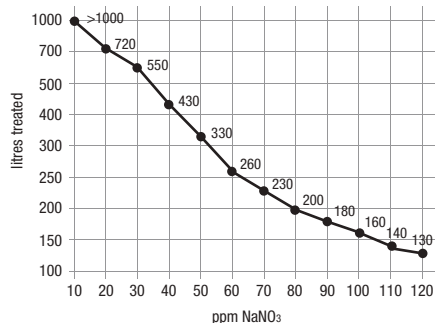

## CERTIFICATIONS



QA AF cartridges are tested and certified under the most stringent procedures worldwide, in compliance with DM 25 (Italy), with the sanitary certification EAC/Ghostreghistracia (Russia) and WaterMark (Australia).

QA-AF cartridges are available in a variety of:

### CONFIGURATIONS:

- SX standard configuration double open end (DOE) available for every height and diameter.
- BX proprietary configuration with double o-ring collar 45 mm, suitable to PLUS 3P BX housings, DP housings, K DP housings.

### MODELS:

- QA-AF series from 5" to 20" OD 2.40" ID 1.10", SX, BX configurations.

### FLOW RATE vs PRESSURE DROP Δp

Tests carried on 10" elements type QA AF 10 SX.  
 Testing mode: 20°C, 3 BAR

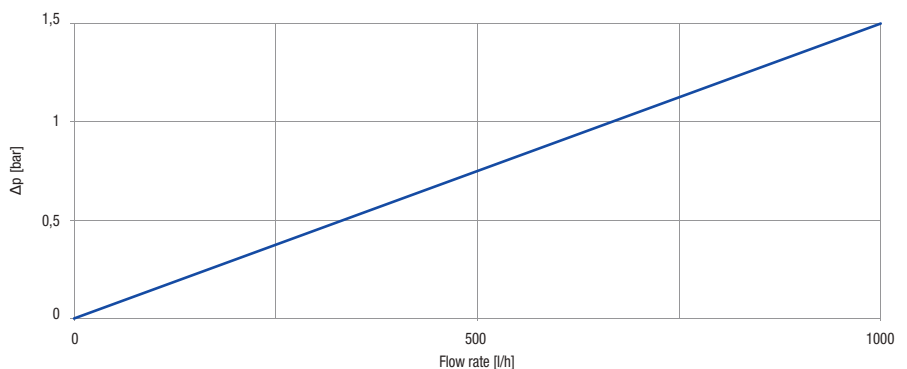





# QA LM mixed bed strong cationic and anionic resin

## Water demineralization.

**Average life-span:** see the table below.

**Maintenance:** none.

**Remark -** Use a pre-filter to protect the cartridge.

Note: the resin changes colour when exhausted.

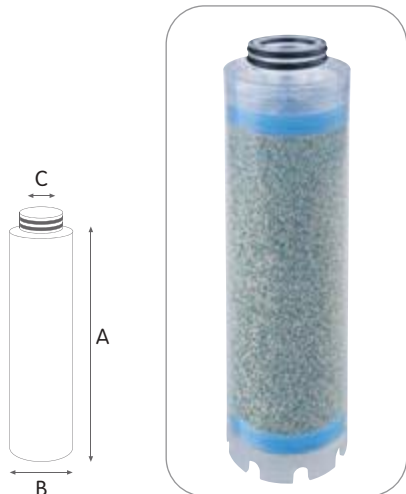
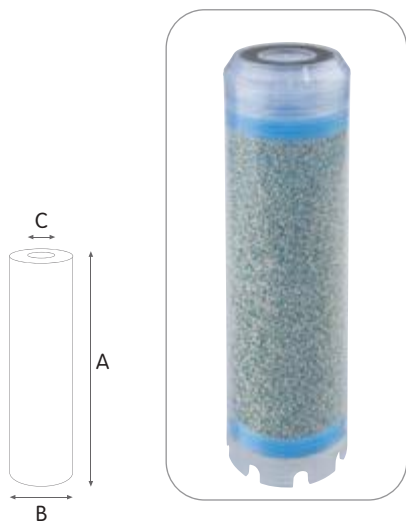

## WORKING CONDITIONS

Max working temperature \_\_\_\_\_ 45°C (113°F)  
 Min working temperature \_\_\_\_\_ 4°C (39,2°F)  
 Max concentration Cl \_\_\_\_\_ 0,1 ppm  
 Max concentration Fe \_\_\_\_\_ 0,1 ppm

## SPECIFICATIONS

Non-toxic materials, suitable for drinking water.  
 Container, end cap and grid: polystyrene.  
 Flat seal SX: SEBS with antimicrobial technology.  
 O-rings BX: EPDM.  
 Containing sponge: polyurethane.  
 Treatment material: mixed bed of strong cationic and strong anionic resins.

Plastic container filled with strong cationic and strong anionic-exchange resin, for the reduction of water salinity. QA-LM cartridges are available with height from 5" to 20".

## QA LM SX

### CONTAINER WITH MIXED BED STRONG CATIONIC AND ANIONIC RESIN WITH DOUBLE OPEN END (DOE)

CODE	MODEL	NOMINAL HEIGHT	RECOMMENDED FLOW RATE l/h	DIMENSIONS MM		
				A	B	C
<b>OD 2,40" x ID 1,10"</b>						
RA5212125	QA 5 LM SX	5"	10	128	70	28
RA5214125	QA 7 LM SX	7"	15	176	70	28
RA5215125	QA 10 LM SX	10"	25	252	70	28
RA5217125	QA 20 LM SX	20"	40	510	70	28

## QA LM BX

### CONTAINER WITH MIXED BED STRONG CATIONIC AND ANIONIC RESIN WITH DOUBLE O-RING COLLAR 45 MM

CODE	MODEL	NOMINAL HEIGHT	RECOMMENDED FLOW RATE l/h	DIMENSIONS MM		
				A	B	C
<b>OD 2,40" x ID 1,10"</b>						
RA5212225	QA 5 LM BX	5"	10	127	70	25
RA5214225	QA 7 LM BX	7"	15	183	70	25
RA5215225	QA 10 LM BX	10"	25	252	70	25
RA5217225	QA 20 LM BX	20"	40	510	70	25

QA-LM cartridges are available in a variety of:

## CONFIGURATIONS:

- SX standard configuration double open end (DOE) available for every height and diameter.
- BX proprietary configuration with double o-ring collar 45 mm, suitable to PLUS 3P BX housings, DP housings, K DP housings.

## MODELS:

- QA-LM series from 5" to 20" OD 2.40" ID 1.10", SX, BX configurations.

### FLOW RATE vs PRESSURE DROP Δp

Tests carried on 10" elements type QA LM 10 SX.  
 Testing mode: 20°C, 3 BAR

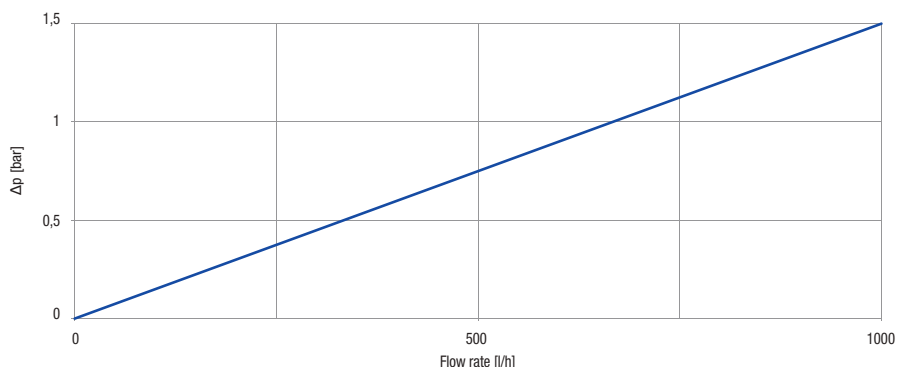

10" cartridge duration in litres starting from a given water intake carbonates concentration (as CaCO<sub>3</sub> ppm)

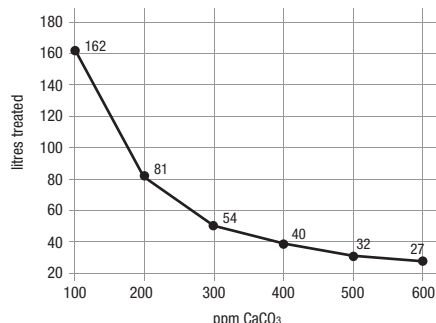

## CERTIFICATIONS



QA LM cartridges are tested and certified under the most stringent procedures worldwide, in compliance with DM 25 (Italy), with the sanitary certification EAC/Ghostreghistracia (Russia) and WaterMark (Australia).



# P empty container

## Fillable container.

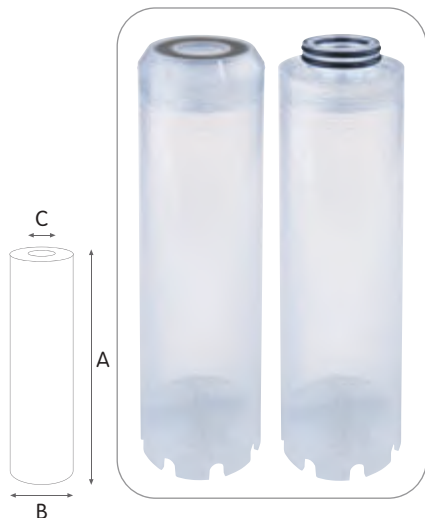

### ACCESSORY ON DEMAND



containing sponge for P series CODE AA9020319

containing sponge for P MIGNON series CODE AA9020317  
not included, to be purchased separately

### CERTIFICATIONS



P cartridges are tested and certified under the most stringent procedures worldwide, in compliance with DM 25 (Italy), with the sanitary certification EAC/Ghostreghistracia (Russia) and WaterMark (Australia).

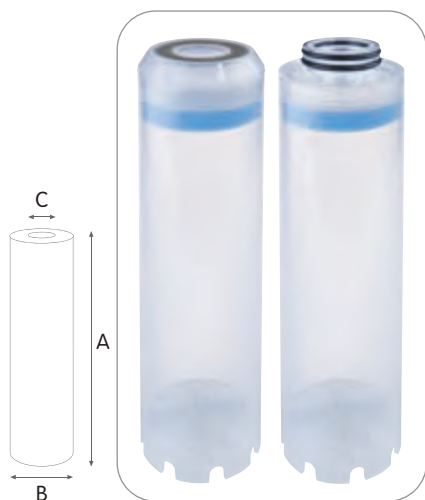

### CERTIFICATIONS



P S cartridges are tested and certified under the most stringent procedures worldwide, in compliance with DM 25 (Italy) and with the sanitary certification EAC (Russia).

## WORKING CONDITIONS

Max working temperature \_\_\_\_\_ 45°C (113°F)  
Min working temperature \_\_\_\_\_ 4°C (39,2°F)

## SPECIFICATIONS

Non-toxic materials, suitable for drinking water.  
Container, end cap and grid: polystyrene.  
Flat seal SX: SEBS with antimicrobial technology.  
O-rings BX: EPDM.  
Containing sponge: polyurethane.

Plastic container fillable with water treatment media available from the range of Atlas Filtri media: granular activated carbon (GAC), polyphosphate crystals, ionic exchange resins. For the use of other media contact Atlas Filtri for approval. P containers are available with height from 5" to 20".

## P SX

### EMPTY CONTAINER WITH DOUBLE OPEN END (DOE)

CODE	MODEL	NOMINAL HEIGHT	DIMENSIONS MM		
			A	B	C
<b>OD 1,77" x ID 0,71"</b>					
RB5170625	P MIGNON SX TS	5" M	125	50	21
<b>OD 2,40" x ID 1,10"</b>					
RB5172125	P 5 SX TS	5"	128	70	28
RB5174125	P 7 SX TS	7"	176	70	28
RB5175125	P 10 SX TS	10"	252	70	28
RB5177125	P 20 SX TS	20"	510	70	28

## P BX

### EMPTY CONTAINER WITH DOUBLE O-RING COLLAR 45 MM

CODE	MODEL	NOMINAL HEIGHT	DIMENSIONS MM		
			A	B	C
<b>OD 2,40" x ID 1,10"</b>					
RB5172225	P 5 BX TS	5"	127	72	25
RB5174225	P 7 BX TS	7"	183	72	25
RB5175225	P 10 BX TS	10"	252	72	25
RB5177225	P 20 BX TS	20"	510	72	25

## P S SX with containing sponge

### EMPTY CONTAINER WITH DOUBLE OPEN END (DOE)

CODE	MODEL	NOMINAL HEIGHT	DIMENSIONS MM		
			A	B	C
<b>OD 1,77" x ID 0,71"</b>					
RB5170622	P MIGNON S SX TS	5" M	125	50	21
<b>OD 2,40" x ID 1,10"</b>					
RB5172122	P 5 S SX TS	5"	128	70	28
RB5174122	P 7 S SX TS	7"	176	70	28
RB5175122	P 10 S SX TS	10"	252	70	28
RB5177122	P 20 S SX TS	20"	510	70	28

## P S BX with containing sponge

### EMPTY CONTAINER WITH DOUBLE O-RING COLLAR 45 MM

CODE	MODEL	NOMINAL HEIGHT	DIMENSIONS MM		
			A	B	C
<b>OD 2,40" x ID 1,10"</b>					
RB5172222	P 5 S BX TS	5"	127	72	25
RB5174222	P 7 S BX TS	7"	183	72	25
RB5175222	P 10 S BX TS	10"	252	72	25
RB5177222	P 20 S BX TS	20"	510	72	25

P and P S containers are available in a variety of:

### CONFIGURATIONS:

- SX standard configuration double open end (DOE) available for every height and diameter.
- BX proprietary configuration with double o-ring collar 45 mm, suitable to PLUS 3P BX housings, DP housings, K DP housings.

### MODELS:

- MIGNON series 5" M OD 1.77" ID 0.71, SX configuration.
- Heights from 5" to 20" OD 2.40" ID 1.10", SX, BX configurations.

# ANTI-SCALE CONDITIONING

Calcareous scale is caused by the presence of calcium and magnesium salts dissolved in water in the form of soluble bicarbonates.

Through the effect of heat, these salts are transformed into insoluble carbonates and tend to agglomerate as crystals, forming calcareous scale on the surface of pipes, coils and storage tanks used for the production of hot water for domestic or industrial use.

Over time, the scale obstructs pipes and forms thick encrustations in heating systems. This leads to inefficiency and to a drastic reduction in energy output, as well as to high servicing and maintenance costs.

## WATER HARDNESS

The quantity of calcium and magnesium salts dissolved determines the "hardness" of the water, which is generally measured in French degrees (°f). One French degree corresponds to 10 ppm of CaCo3 (calcium carbonate).

Classification of water on the basis of hardness:

**Soft water:** below 5 °f.

**Moderately hard water:** from 5 to 7 °f.

**Water of average hardness:** from 8 to 12 °f.

**Hard water:** from 13 to 25 °f

**Extremely hard water:** 26 °f and beyond.

Water hardness can be tested rapidly using EASYTEST strips, or more accurately using the HARDNESS CONTROL KIT.



CODE	PRODUCT
RE8000011	EASY TEST TH IN BLISTER WITH 5 STRIPS
RE8000111	EASY TEST TH IN PACK WITH 50 BLISTERS

				Total hardness °f
Green	Green	Green	Green	5°
Purple	Green	Green	Green	7°
Purple	Purple	Green	Green	12°
Purple	Purple	Purple	Green	25°
Purple	Purple	Purple	Purple	37°

## ANTI-SCALE TREATMENT WITH POLYPHOSPHATES (CHEMICAL CONDITIONING)

Polyphosphate treatment is a simple, effective and economic solution for the problem of scale deposits. When dissolved in water, the polyphosphate prevents the formation of calcium

carbonate encrustation by acting upon its crystallization, without affecting the hardness of the water. Over time, it also tends to break down existing deposits. Polyphosphates also provide effective protection against corrosion by creating a thin protective film on the surface of the pipes, coils and water heaters.

### - Proportional dosing systems with polyphosphate powder or ready-to-use refill **DOSAPLUS.**

Designed for the use with drinking water.

### - Proportional dosing systems with polyphosphate crystals **DOSAPROP and DOSAPROP-HA.**

Designed for the use with drinking water.

### - Non-proportional dosing systems with polyphosphate crystals **DOSAFOS, DOSAFOS-HA, and DOSAL.**

These dosing systems are designed for "technical" applications which are not intended to provide drinking water.

## ANTI-SCALE TREATMENT WITH MAGNETIC SYSTEMS (PHYSICAL CONDITIONING).

The water is conditioned using a magnetic field which modifies the structure of the calcium and magnesium salt crystals, preventing the formation of calcium carbonate encrustations. It does not alter the hardness of the water or its salt content. This type of treatment does not provide protection against corrosion.

### - Magnetic anti-scale systems **MAG conditioners.**

MAG are designed for household use for the treatment of drinking water.

**ENERGY CONSUMPTION**

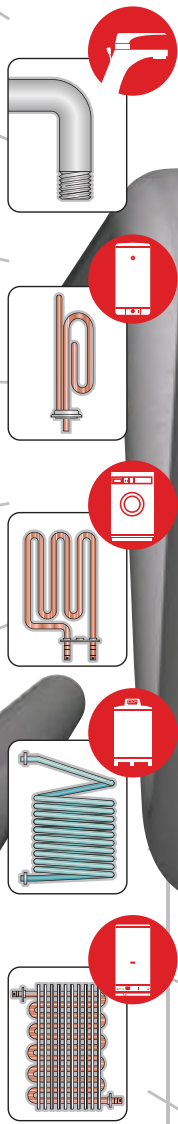
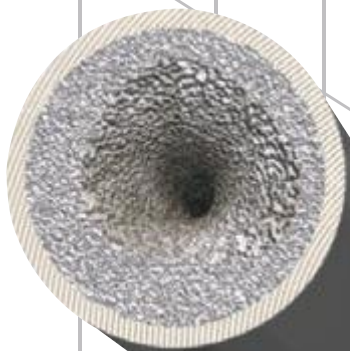

**ENERGY SAVING**

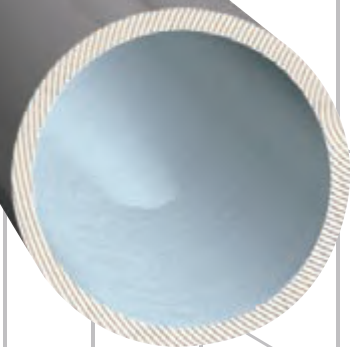

ANTI-SCALE  
SYSTEMS





# DOSAPLUS

proportional dosing systems  
with polyphosphate powder and with Poliphos

Proportional dosing systems  
designed for the use with drinking water



# DOSAPLUS WITH POLYPHOSPHATE POWDER

## PROPORTIONAL DOSING SYSTEMS

Proportional dosing system equipped with device providing "Venturi" effect.

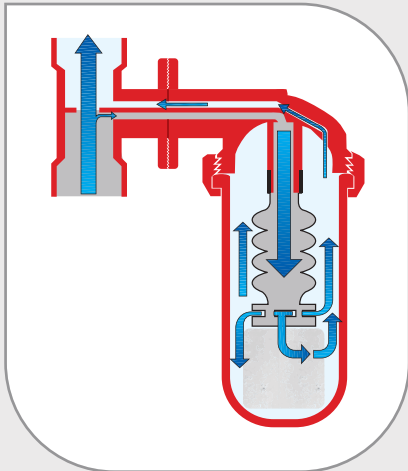

**POLIPHOS A** ready-to-use powder refill in package of 12 refills (CODE RE5000057) or in skinpack of 2 refill (CODE RE5000055), for DOSAPLUS 2, 3, 4.



**POLIPHOS B** ready-to-use powder refill (CODE RE5000054) in package of 1 refill for DOSAPLUS 5, 6, 7.



**POLYPHOSPHATE POWDER PACK** 1 kg (CODE RE8020002)

## CERTIFICATIONS



Housings are tested and certified under the most stringent procedures worldwide, in compliance with DM 25 (Italy), with the sanitary certification EAC/ Ghostreghistracia (Russia) and WaterMark (Australia).

## ACCESSORIES ON DEMAND



boiler adaptor for Dosaplus 2-3-4-13-14 CODE RE7407030



-LUBRIKIT- single-dose lubricant for housing o-ring  
CODE RE9020650

## ACCESSORIES INCLUDED



-X- spanner for Dosaplus 5-6-7



spanner for Dosaplus 2

spanner for Dosaplus 3-4

## REFILL INCLUDED



2 Poliphos A charge for Dosaplus 2-3-4



1 Poliphos B charge for Dosaplus 5-6-7

## SYMBOLS LEGEND



For domestic use



For technical and industrial use



Filter housings made in PET, a highly recyclable plastic, are manufactured with a proprietary procedure saving up to 60% of energy in injection molding compared with standard plastics. That is one of Atlas Filtri commitments to comply with Kyoto Treaty for the reduction of green house gas (CO<sub>2</sub>) emissions in the atmosphere.



# DOSAPLUS 2-3-4

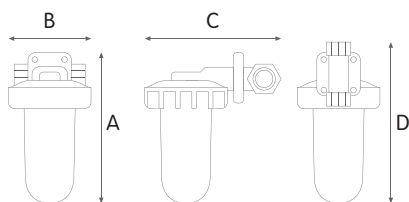

### WORKING CONDITIONS

Max working pressure \_\_\_\_\_ 8 bar (116 psi)  
 Max working temperature \_\_\_\_\_ 45°C (113°F)  
 Min working temperature \_\_\_\_\_ 4°C (39,2°F)  
 Max total hardness \_\_\_\_\_ 35°F (350 ppm CaCO<sub>3</sub>)

**Remark** - the treated water can be heated up to 75°C - 80°C, above that temperature the polyphosphate loses gradually its effectiveness.

### SPECIFICATIONS

Non-toxic materials, suitable for drinking water.  
 Dosaplus 2 head: CW 602 N brass.  
 Dosaplus 3-4 head: reinforced polypropylene.  
 Dosaplus 2 ring nut: CW 602 N brass.  
 Bowl: SAN.  
 O-ring: EPDM.  
 Breather-valve: body stainless steel, o-ring EPDM.  
 Bellow: rubber (NBR).  
 IN/OUT threads: CW 614 N brass.

DOSAPLUS 2 with polyphosphate ready-to-use powder refill and with screw for by-pass and dosing setting

#### HOUSINGS WITH BRASS BSP THREADS

CODE	MODEL	SUITABLE REFILL	IN/OUT	AVERAGE FLOW RATE (l/h)	MAXIMUM FLOW RATE (l/h)	DIMENSIONS mm			
						A	B	C	D
RE4050212	DOSAPLUS 2	POLIPHOS A	1/2"	1500	1500	150	65	126	145



DOSAPLUS 3 with polyphosphate ready-to-use powder refill and by-pass

#### HOUSINGS WITH BRASS BSP THREADS

CODE	MODEL	SUITABLE REFILL	IN/OUT	AVERAGE FLOW RATE (l/h)	MAXIMUM FLOW RATE (l/h)	DIMENSIONS mm			
						A	B	C	D
RE4050213	DOSAPLUS 3	POLIPHOS A	1/2"	1500	1500	150	65	112	145



DOSAPLUS 4 with polyphosphate ready-to-use powder refill

#### HOUSINGS WITH BRASS BSP THREADS

CODE	MODEL	SUITABLE REFILL	IN/OUT	AVERAGE FLOW RATE (l/h)	MAXIMUM FLOW RATE (l/h)	DIMENSIONS mm			
						A	B	C	D
RE4050214	DOSAPLUS 4	POLIPHOS A	1/2"	1500	1500	150	65	126	145

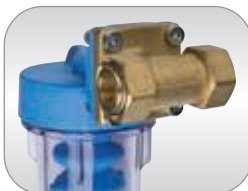



# DOSAPLUS 13-14

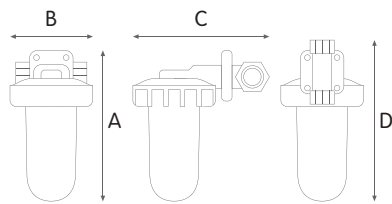

## WORKING CONDITIONS

Max working pressure \_\_\_\_\_ 8 bar (116 psi)  
 Max working temperature \_\_\_\_\_ 45°C (113°F)  
 Min working temperature \_\_\_\_\_ 4°C (39,2°F)  
 Max total hardness \_\_\_\_\_ 35°f (350 ppm CaCO<sub>3</sub>)

## SPECIFICATIONS

Non-toxic materials, suitable for drinking water.  
 Head: reinforced polypropylene.  
 Bowl: SAN.  
 O-ring: EPDM.  
 Breather-valve: body stainless steel, o-ring EPDM.  
 Bellow: rubber (NBR).  
 IN/OUT threads: reinforced polypropylene 1/2" BSP.

**Remark** - the treated water can be heated up to 75°C - 80°C, above that temperature the polyphosphate loses gradually its effectiveness.

DOSAPLUS 13 with polyphosphate ready-to-use powder refill, by-pass and plastic rotational group



### HOUSINGS WITH BRASS BSP THREADS

CODE	MODEL	SUITABLE REFILL	IN/OUT	AVERAGE FLOW RATE (l/h)	MAXIMUM FLOW RATE (l/h)	DIMENSIONS mm			
						A	B	C	D
RE4050313	DOSAPLUS 13	POLIPHOS A	1/2"	1500	1500	150	65	112	145



DOSAPLUS 14 with polyphosphate ready-to-use powder refill and plastic rotational group



### HOUSINGS WITH PLASTIC BSP THREADS

CODE	MODEL	SUITABLE REFILL	IN/OUT	AVERAGE FLOW RATE (l/h)	MAXIMUM FLOW RATE (l/h)	DIMENSIONS mm			
						A	B	C	D
RE4050314	DOSAPLUS 14	POLIPHOS A	1/2"	1500	1500	150	65	126	145





# DOSAPLUS 5-6-7

## WORKING CONDITIONS

Max working pressure \_\_\_\_\_ 8 bar (116 psi)  
 Max working temperature \_\_\_\_\_ 45°C (113°F)  
 Min working temperature \_\_\_\_\_ 4°C (39,2°F)  
 Max total hardness \_\_\_\_\_ 35°F (350 ppm CaCO<sub>3</sub>)

**Remark** - the treated water can be heated up to 75°C - 80°C, above that temperature the polyphosphate loses gradually its effectiveness.

## SPECIFICATIONS

Non-toxic materials, suitable for drinking water.  
 Head: reinforced polypropylene.  
 Bowl: PET.  
 O-rings: EPDM.  
 Breather-valve: body stainless steel, o-ring EPDM.  
 Bellow: rubber (NBR).  
 Brass rotational connection group: CW 617 N brass.  
 Plastic rotational connection group: reinforced nylon.  
 Rotational connection group gaskets: NBR.

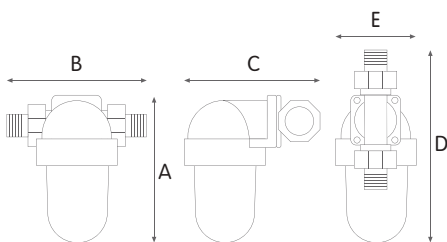

## DOSAPLUS 5-6 with polyphosphate ready-to-use powder refill and brass rotational group

### HOUSINGS WITH BRASS BSP THREADS

CODE	MODEL	SUITABLE REFILL	IN/OUT	AVERAGE FLOW RATE (l/h)	MAXIMUM FLOW RATE (l/h)	DIMENSIONS mm				
						A	B	C	D	E
RE4050500	DOSAPLUS 5	POLIPHOS B	3/4"	2500	3000	208	164	164	256	105
RE4050515	DOSAPLUS 6	POLIPHOS B	1"	3500	5000	208	168	164	259	105



## DOSAPLUS 7 with polyphosphate ready-to-use powder refill and plastic rotational group

### HOUSINGS WITH PLASTIC BSP THREADS

CODE	MODEL	SUITABLE REFILL	IN/OUT	AVERAGE FLOW RATE (l/h)	MAXIMUM FLOW RATE (l/h)	DIMENSIONS mm				
						A	B	C	D	E
RE4050520	DOSAPLUS 7	POLIPHOS B	3/4"	2500	3000	208	172	170	258	105
	DOSAPLUS 7	POLIPHOS B	1"	3500	5000	208	172	170	258	105







# DOSAPROP PLUS

proportional dosing systems  
with polyphosphate crystals

Dosing systems designed for the use with drinking water



# DOSAPROP PLUS

DOSING SYSTEMS WITH POLYPHOSPHATE CRYSTALS

Proportional dosing system equipped with device providing "Venturi" effect.



## DOSAPROP PLUS



## DOSAPROP PLUS HA



**POLYPHOSPHATE CRYSTALS REFILL** 0.5 kg and 1.5 kg pack with 6/10 (small) crystals or 10/20 (large) crystals, refill TO DOSAPROP PLUS 3P and DOSAPROP MIGNON PLUS.



**HA polyphosphate cartridges with antimicrobial flat seal**, heights 5", 7", 10", replacements for DOSAPROP HA.

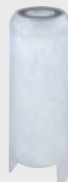

**HA MIGNON polyphosphate cartridge with antimicrobial flat seal** 5" M refill to DOSAPROP MIGNON HA.

### CERTIFICATIONS



Housings are tested and certified under the most stringent procedures worldwide, in compliance with DM 25 (Italy), with the sanitary certification ACS (France), EAC/Ghostregistracia (Russia) and WaterMark (Australia).

### ACCESSORIES ON DEMAND



-U- spanner CODE RB7403013



-L- spanner for Mignon 3P  
CODE RB7403001

-M- spanner for Mignon 2P  
CODE RB7403002



-S- wall bracket CODE RB7400007



3/4" brass nipples with o-ring (pair) CODE RB7404001

1" brass nipples with o-ring (pair) CODE RB7404002



3/4" plastic nipple with o-ring CODE LB7404012



-LUBRIKIT- single-dose lubricant for housing o-ring  
CODE RE9020650

### SYMBOLS LEGEND



For domestic use



For technical and industrial use











Filter housings made in PET, a highly recyclable plastic, are manufactured with a proprietary procedure saving up to 60% of energy in injection molding compared with standard plastics. That is one of Atlas Filtri commitments to comply with Kyoto Treaty for the reduction of green house gas (CO<sub>2</sub>) emissions in the atmosphere.

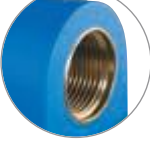

DOSAPROP **SENIOR PLUS 3P** **A** **FO** **SX**

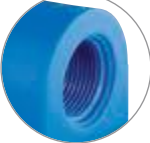
HOUSINGS MODEL      VERSION      IN / OUT      THREADS TYPE      POLYPHOSPHATE CHARGE TYPE

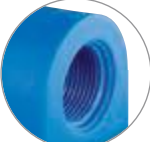
<b>MIGNON L 3P</b>	<b>3P</b>	<b>M 1/2"</b>	<b>FO - BRASS BSP *</b>	<b>SX - LOOSE CRYSTALS</b>
		<b>A 3/4"</b>		
<b>MIGNON L 2P</b>	<b>2P</b>	<b>B 1"</b>	<b>FP - PLASTIC BSP *</b>	<b>SX + HA CARTRIDGE</b>
				
			<b>FP-NPT - PLASTIC NPT **</b>	
				

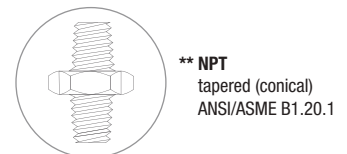
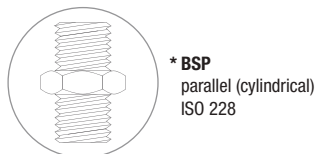



# DOSAPROP PLUS 3P

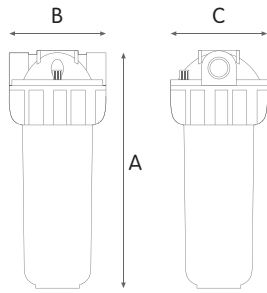

## WORKING CONDITIONS

Max working pressure:  
 BSP versions \_\_\_\_\_ 8 bar (116 psi)  
 NPT versions \_\_\_\_\_ 8,6 bar (125 psi)  
 Max working temperature \_\_\_\_\_ 35°C (95°F)  
 Min working temperature \_\_\_\_\_ 4°C (39,2°F)  
 Max total hardness \_\_\_\_\_ 50°f (500 ppm CaCO<sub>3</sub>)

**Remark** - Water treated with polyphosphate can be heated up to a max temperature of 75° - 80°C, beyond that temperature the polyphosphate gradually loses its efficacy.

## SPECIFICATIONS

Non-toxic materials, suitable for drinking water.  
 Head and ring nut: reinforced polypropylene.  
 Bowl: PET.  
 O-ring: EPDM.  
 Breather-valve: body polypropylene, o-ring EPDM.  
 IN/OUT brass threads: CW 617 N brass.

## DOSAPROP PLUS 3P SX with polyphosphate loose crystals

### HOUSINGS WITH BRASS BSP THREADS

CODE	MODEL	APPLICABLE REFILL	g*	IN/OUT	DIMENSIONS mm		
					A	B	C
RA401T831	DOSAPROP MEDIUM PLUS 3P AFO SX	LOOSE CRYSTALS	650	3/4"	191	133	130
RA401T851	DOSAPROP MEDIUM PLUS 3P BFO SX	LOOSE CRYSTALS	650	1"	197	145	130
RA401T931	DOSAPROP JUNIOR PLUS 3P AFO SX	LOOSE CRYSTALS	1050	3/4"	241	133	130
RA401T951	DOSAPROP JUNIOR PLUS 3P BFO SX	LOOSE CRYSTALS	1050	1"	247	145	130
RA401T131	DOSAPROP SENIOR PLUS 3P AFO SX	LOOSE CRYSTALS	1550	3/4"	315	133	130
RA401T151	DOSAPROP SENIOR PLUS 3P BFO SX	LOOSE CRYSTALS	1550	1"	321	145	130

g\* = polyphosphate crystals amount in grams

### HOUSINGS WITH PLASTIC BSP THREADS

CODE	MODEL	APPLICABLE REFILL	g*	IN/OUT	DIMENSIONS mm		
					A	B	C
RA401T836	DOSAPROP MEDIUM PLUS 3P AFP SX	LOOSE CRYSTALS	650	3/4"	191	133	130
RA401T856	DOSAPROP MEDIUM PLUS 3P BFP SX	LOOSE CRYSTALS	650	1"	197	145	130
RA401T936	DOSAPROP JUNIOR PLUS 3P AFP SX	LOOSE CRYSTALS	1050	1/2"	241	133	130
RA401T956	DOSAPROP JUNIOR PLUS 3P BFP SX	LOOSE CRYSTALS	1050	1"	247	145	130
RA401T136	DOSAPROP SENIOR PLUS 3P AFP SX	LOOSE CRYSTALS	1550	3/4"	315	133	130
RA401T156	DOSAPROP SENIOR PLUS 3P BFP SX	LOOSE CRYSTALS	1550	1"	321	145	130

### HOUSINGS WITH PLASTIC NPT THREADS

CODE	MODEL	APPLICABLE REFILL	g*	IN/OUT	DIMENSIONS mm		
					A	B	C
RA401T837	DOSAPROP MEDIUM PLUS 3P AFP NPT SX	LOOSE CRYSTALS	650	3/4"	191	133	130
RA401T857	DOSAPROP MEDIUM PLUS 3P BFP NPT SX	LOOSE CRYSTALS	650	1"	197	145	130
RA401T937	DOSAPROP JUNIOR PLUS 3P AFP NPT SX	LOOSE CRYSTALS	1050	3/4"	241	133	130
RA401T957	DOSAPROP JUNIOR PLUS 3P BFP NPT SX	LOOSE CRYSTALS	1050	1"	247	145	130
RA401T137	DOSAPROP SENIOR PLUS 3P AFP NPT SX	LOOSE CRYSTALS	1550	3/4"	315	133	130
RA401T157	DOSAPROP SENIOR PLUS 3P BFP NPT SX	LOOSE CRYSTALS	1550	1"	321	145	130

g\* = polyphosphate crystals amount in grams

Some items in the list are subject to minimum order quantities and/or to longer delivery term.



# DOSAPROP PLUS 3P HA

## WORKING CONDITIONS

Max working pressure:  
 BSP versions \_\_\_\_\_ 8 bar (116 psi)  
 NPT versions \_\_\_\_\_ 8,6 bar (125 psi)  
 Max working temperature \_\_\_\_\_ 35°C (95°F)  
 Min working temperature \_\_\_\_\_ 4°C (39,2°F)  
 Max total hardness \_\_\_\_\_ 50°f (500 ppm CaCO<sub>3</sub>)

## SPECIFICATIONS

Non-toxic materials, suitable for drinking water.  
 Head and ring nut: reinforced polypropylene.  
 Bowl: PET.  
 O-ring: EPDM.  
 Breather-valve: body polypropylene, o-ring EPDM.  
 IN/OUT brass threads: CW 617 N brass.

**Remark** - Water treated with polyphosphate can be heated up to a max temperature of 75° - 80°C, beyond that temperature the polyphosphate gradually loses its efficacy.

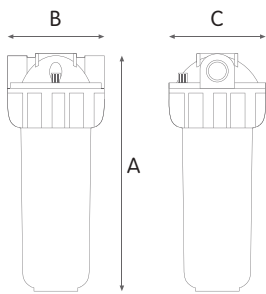

## DOSAPROP PLUS 3P SX HA with HA polyphosphate crystals cartridge

### HOUSINGS WITH BRASS BSP THREADS

CODE	MODEL	SUITABLE CARTRIDGE	IN/OUT	DIMENSIONS mm		
				A	B	C
RA401T834	DOSAPROP MEDIUM PLUS 3P AFO SX + HA	HA 5" SX CARTRIDGE	3/4"	191	133	130
RA401T854	DOSAPROP MEDIUM PLUS 3P BFO SX + HA	HA 5" SX CARTRIDGE	1"	197	145	130
RA401T934	DOSAPROP JUNIOR PLUS 3P AFO SX + HA	HA 7" SX CARTRIDGE	3/4"	241	133	130
RA401T954	DOSAPROP JUNIOR PLUS 3P BFO SX + HA	HA 7" SX CARTRIDGE	1"	247	145	130
RA401T134	DOSAPROP SENIOR PLUS 3P AFO SX + HA	HA 10" SX CARTRIDGE	3/4"	315	133	130
RA401T154	DOSAPROP SENIOR PLUS 3P BFO SX + HA	HA 10" SX CARTRIDGE	1"	321	145	130

### HOUSINGS WITH PLASTIC BSP THREADS

CODE	MODEL	SUITABLE CARTRIDGE	IN/OUT	DIMENSIONS mm		
				A	B	C
RA401T838	DOSAPROP MEDIUM PLUS 3P AFP SX + HA	HA 5" SX CARTRIDGE	3/4"	191	133	130
RA401T858	DOSAPROP MEDIUM PLUS 3P BFP SX + HA	HA 5" SX CARTRIDGE	1"	197	145	130
RA401T938	DOSAPROP JUNIOR PLUS 3P AFP SX + HA	HA 7" SX CARTRIDGE	3/4"	241	133	130
RA401T958	DOSAPROP JUNIOR PLUS 3P BFP SX + HA	HA 7" SX CARTRIDGE	1"	247	145	130
RA401T138	DOSAPROP SENIOR PLUS 3P AFP SX + HA	HA 10" SX CARTRIDGE	3/4"	315	133	130
RA401T158	DOSAPROP SENIOR PLUS 3P BFP SX + HA	HA 10" SX CARTRIDGE	1"	321	145	130

### HOUSINGS WITH PLASTIC NPT THREADS

CODE	MODEL	SUITABLE CARTRIDGE	IN/OUT	DIMENSIONS mm		
				A	B	C
RA401T839	DOSAPROP MEDIUM PLUS 3P AFP NPT SX + HA	HA 5" SX CARTRIDGE	3/4"	191	133	130
RA401T859	DOSAPROP MEDIUM PLUS 3P BFP NPT SX + HA	HA 5" SX CARTRIDGE	1"	197	145	130
RA401T939	DOSAPROP JUNIOR PLUS 3P AFP NPT SX + HA	HA 7" SX CARTRIDGE	3/4"	241	133	130
RA401T959	DOSAPROP JUNIOR PLUS 3P BFP NPT SX + HA	HA 7" SX CARTRIDGE	1"	247	145	130
RA401T139	DOSAPROP SENIOR PLUS 3P AFP NPT SX + HA	HA 10" SX CARTRIDGE	3/4"	315	133	130
RA401T159	DOSAPROP SENIOR PLUS 3P BFP NPT SX + HA	HA 10" SX CARTRIDGE	1"	321	145	130

Some items in the list are subject to minimum order quantities and/or to longer delivery term.



# DOSAPROP PLUS 2P

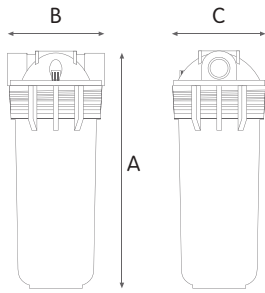

## WORKING CONDITIONS

Max working pressure \_\_\_\_\_ 8 bar (116 psi)  
 Max working temperature \_\_\_\_\_ 35°C (95°F)  
 Min working temperature \_\_\_\_\_ 4°C (39,2°F)  
 Max total hardness \_\_\_\_\_ 50°f (500 ppm CaCO<sub>3</sub>)

## SPECIFICATIONS

Non-toxic materials, suitable for drinking water.  
 Head: reinforced polypropylene.  
 Bowl: SAN.  
 O-ring: EPDM.  
 Breather-valve: body polypropylene, o-ring EPDM.  
 IN/OUT brass threads: CW 617 N brass.

**Remark** - Water treated with polyphosphate can be heated up to a max temperature of 75° - 80°C, beyond that temperature the polyphosphate gradually loses its efficacy.



## DOSAPROP PLUS 2P SX with polyphosphate loose crystals

### HOUSINGS WITH BRASS BSP THREADS

CODE	MODEL	APPLICABLE REFILL	g*	IN/OUT	DIMENSIONS mm		
					A	B	C
RA401P732	DOSAPROP CADET PLUS 2P AFO SX	LOOSE CRYSTALS	400	3/4"	191	133	130
RA401P752	DOSAPROP CADET PLUS 2P BFO SX	LOOSE CRYSTALS	400	1"	197	145	130
RA401P032	DOSAPROP JUNIOR PLUS 2P AFO SX	LOOSE CRYSTALS	950	3/4"	241	133	130
RA401P052	DOSAPROP JUNIOR PLUS 2P BFO SX	LOOSE CRYSTALS	950	1"	247	145	130
RA401P232	DOSAPROP SENIOR PLUS 2P AFO SX	LOOSE CRYSTALS	1500	3/4"	315	133	130
RA401P252	DOSAPROP SENIOR PLUS 2P BFO SX	LOOSE CRYSTALS	1500	1"	321	145	130

g\* = polyphosphate crystals amount in grams

### HOUSINGS WITH PLASTIC BSP THREADS

CODE	MODEL	APPLICABLE REFILL	g*	IN/OUT	DIMENSIONS mm		
					A	B	C
RA401P736	DOSAPROP CADET PLUS 2P AFP SX	LOOSE CRYSTALS	400	3/4"	191	133	130
RA401P756	DOSAPROP CADET PLUS 2P BFP SX	LOOSE CRYSTALS	400	1"	197	145	130
RA401P036	DOSAPROP JUNIOR PLUS 2P AFP SX	LOOSE CRYSTALS	950	3/4"	241	133	130
RA401P056	DOSAPROP JUNIOR PLUS 2P BFP SX	LOOSE CRYSTALS	950	1"	247	145	130
RA401P236	DOSAPROP SENIOR PLUS 2P AFP SX	LOOSE CRYSTALS	1500	3/4"	315	133	130
RA401P256	DOSAPROP SENIOR PLUS 2P BFP SX	LOOSE CRYSTALS	1500	1"	321	145	130

### HOUSINGS WITH PLASTIC NPT THREADS

CODE	MODEL	APPLICABLE REFILL	g*	IN/OUT	DIMENSIONS mm		
					A	B	C
RA401P737	DOSAPROP CADET PLUS 2P AFP NPT SX	LOOSE CRYSTALS	400	3/4"	191	133	130
RA401P757	DOSAPROP CADET PLUS 2P BFP NPT SX	LOOSE CRYSTALS	400	1"	197	145	130
RA401P037	DOSAPROP JUNIOR PLUS 2P AFP NPT SX	LOOSE CRYSTALS	950	3/4"	241	133	130
RA401P057	DOSAPROP JUNIOR PLUS 2P BFP NPT SX	LOOSE CRYSTALS	950	1"	247	145	130
RA401P237	DOSAPROP SENIOR PLUS 2P AFP NPT SX	LOOSE CRYSTALS	1500	3/4"	315	133	130
RA401P257	DOSAPROP SENIOR PLUS 2P BFP NPT SX	LOOSE CRYSTALS	1500	1"	321	145	130

g\* = polyphosphate crystals amount in grams



# DOSAPROP PLUS 2P HA

## WORKING CONDITIONS

Max working pressure \_\_\_\_\_ 8 bar (116 psi)  
 Max working temperature \_\_\_\_\_ 35°C (95°F)  
 Min working temperature \_\_\_\_\_ 4°C (39,2°F)  
 Max total hardness \_\_\_\_\_ 50°f (500 ppm CaCO<sub>3</sub>)

**Remark** - Water treated with polyphosphate can be heated up to a max temperature of 75° - 80°C, beyond that temperature the polyphosphate gradually loses its efficacy.

## SPECIFICATIONS

Non-toxic materials, suitable for drinking water.  
 Head: reinforced polypropylene.  
 Bowl: SAN.  
 O-ring: EPDM.  
 Breather-valve: body polypropylene, o-ring EPDM.  
 IN/OUT brass threads: CW 617 N brass.

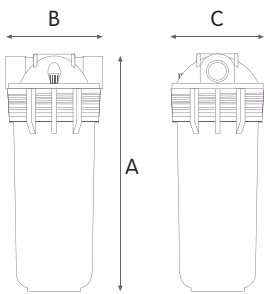

## DOSAPROP PLUS 2P SX HA with HA polyphosphate crystals cartridge

### HOUSINGS WITH BRASS BSP THREADS

CODE	MODEL	SUITABLE CARTRIDGE	IN/OUT	DIMENSIONS mm		
				A	B	C
RA401P034	DOSAPROP JUNIOR PLUS 2P AFO SX + HA	HA 7" SX CARTRIDGE	3/4"	241	133	130
RA401P054	DOSAPROP JUNIOR PLUS 2P BFO SX + HA	HA 7" SX CARTRIDGE	1"	247	145	130
RA401P234	DOSAPROP SENIOR PLUS 2P AFO SX + HA	HA 10" SX CARTRIDGE	3/4"	315	133	130
RA401P254	DOSAPROP SENIOR PLUS 2P BFO SX + HA	HA 10" SX CARTRIDGE	1"	321	145	130

### HOUSINGS WITH PLASTIC BSP THREADS

CODE	MODEL	SUITABLE CARTRIDGE	IN/OUT	DIMENSIONS mm		
				A	B	C
RA401P038	DOSAPROP JUNIOR PLUS 2P AFP SX + HA	HA 7" SX CARTRIDGE	3/4"	241	133	130
RA401P058	DOSAPROP JUNIOR PLUS 2P BFP SX + HA	HA 7" SX CARTRIDGE	1"	247	145	130
RA401P238	DOSAPROP SENIOR PLUS 2P AFP SX + HA	HA 10" SX CARTRIDGE	3/4"	315	133	130
RA401P258	DOSAPROP SENIOR PLUS 2P BFP SX + HA	HA 10" SX CARTRIDGE	1"	321	145	130

### HOUSINGS WITH PLASTIC NPT THREADS

CODE	MODEL	SUITABLE CARTRIDGE	IN/OUT	DIMENSIONS mm		
				A	B	C
RA401P039	DOSAPROP JUNIOR PLUS 2P AFP NPT SX + HA	HA 7" SX CARTRIDGE	3/4"	241	133	130
RA401P059	DOSAPROP JUNIOR PLUS 2P BFP NPT SX + HA	HA 7" SX CARTRIDGE	1"	247	145	130
RA401P239	DOSAPROP SENIOR PLUS 2P AFP NPT SX + HA	HA 10" SX CARTRIDGE	3/4"	315	133	130
RA401P259	DOSAPROP SENIOR PLUS 2P BFP NPT SX + HA	HA 10" SX CARTRIDGE	1"	321	145	130





# DOSAPROP MIGNON PLUS 3P

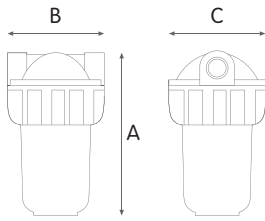

### WORKING CONDITIONS

Max working pressure \_\_\_\_\_ 8 bar (116 psi)  
 Max working temperature \_\_\_\_\_ 35°C (95°F)  
 Min working temperature \_\_\_\_\_ 4°C (39,2°F)  
 Max total hardness \_\_\_\_\_ 50°f (500 ppm CaCO<sub>3</sub>)

### SPECIFICATIONS

Non-toxic materials, suitable for drinking water.  
 Head / ring nut: reinforced polypropylene.  
 Bowl: SAN.  
 O-ring: EPDM.  
 IN/OUT brass threads: CW 617 N brass.

**Remark** - Water treated with polyphosphate can be heated up to a max temperature of 75° - 80°C, beyond that temperature the polyphosphate gradually loses its efficacy.

## DOSAPROP MIGNON PLUS 3P with polyphosphate loose crystals

### HOUSINGS WITH BRASS BSP THREADS

CODE	MODEL	APPLICABLE REFILL	g*	IN/OUT	DIMENSIONS mm		
					A	B	C
RA401P511	DOSAPROP MIGNON PLUS L 3P MFO	LOOSE CRYSTALS	265	1/2"	176	94	89

g\* = polyphosphate crystals amount in grams



## DOSAPROP MIGNON PLUS 3P with HA polyphosphate crystals cartridge

### HOUSINGS WITH BRASS BSP THREADS

CODE	MODEL	SUITABLE CARTRIDGE	IN/OUT	DIMENSIONS mm		
				A	B	C
RA401P514	DOSAPROP MIGNON PLUS L 3P MFO + HA	HA 5" M SX CARTRIDGE	1/2"	176	94	89

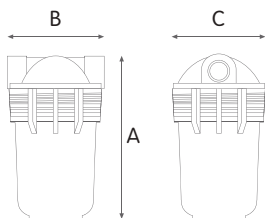

## DOSAPROP MIGNON PLUS 2P with polyphosphate loose crystals

### HOUSINGS WITH BRASS BSP THREADS

CODE	MODEL	APPLICABLE REFILL	g*	IN/OUT	DIMENSIONS mm		
					A	B	C
RA401P612	DOSAPROP MIGNON PLUS L 2P MFO	LOOSE CRYSTALS	275	1/2"	176	94	89

g\* = polyphosphate crystals amount in grams

## DOSAPROP MIGNON PLUS 2P with HA polyphosphate crystals cartridge

### HOUSINGS WITH BRASS BSP THREADS

CODE	MODEL	SUITABLE CARTRIDGE	IN/OUT	DIMENSIONS mm		
				A	B	C
RA401P614	DOSAPROP MIGNON PLUS L 2P MFO + HA	HA 5" M SX CARTRIDGE	1/2"	176	94	89

# DOSAPROP MIGNON PLUS 2P



# DOSAFOS PLUS

non-proportional dosing systems  
with polyphosphate crystals

Dosing systems designed for the use on not-for-drinking water applications

# DOSAFOS PLUS

DOSING SYSTEMS WITH POLYPHOSPHATE CRYSTALS



## DOSAFOS PLUS



## DOSAFOS PLUS HA



**POLYPHOSPHATE CRYSTALS REFILL** 0.5 kg and 1.5 kg pack with 6/10 (small) crystals or 10/20 (large) crystals, refill TO DOSAFOS PLUS 3P and DOSAFOS MIGNON PLUS.



**HA polyphosphate cartridges with antimicrobial flat seal**, heights 5", 7", 10", replacements for DOSAFOS HA.



**HA MIGNON polyphosphate cartridge with antimicrobial flat seal** 5" M refill to DOSAFOS MIGNON HA.

### CERTIFICATIONS



Housings are tested and certified under the most stringent procedures worldwide, in compliance with DM 25 (Italy), with the sanitary certification ACS (France), EAC/Ghostregistracia (Russia) and WaterMark (Australia).

### ACCESSORIES ON DEMAND



-U- spanner CODE RB7403013



-L- spanner for Mignon 3P  
CODE RB7403001

-M- spanner for Mignon 2P  
CODE RB7403002



-S- wall bracket CODE RB7400007



3/4" brass nipples with o-ring (pair) CODE RB7404001

1" brass nipples with o-ring (pair) CODE RB7404002



3/4" plastic nipple with o-ring CODE LB7404012



-LUBRIKIT- single-dose lubricant for housing o-ring  
CODE RE9020650

### SYMBOLS LEGEND



For domestic use



For technical and industrial use



Filter housings made in PET, a highly recyclable plastic, are manufactured with a proprietary procedure saving up to 60% of energy in injection molding compared with standard plastics. That is one of Atlas Filtri commitments to comply with Kyoto Treaty for the reduction of green house gas (CO<sub>2</sub>) emissions in the atmosphere.



DOSAFOS SENIOR PLUS 3P

HOUSINGS MODEL

VERSION

A

FO

SX

IN / OUT

THREADS TYPE

POLYPHOSPHATE CHARGE TYPE



M 1/2"  
A 3/4"  
B 1"

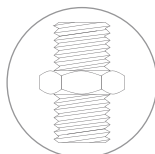
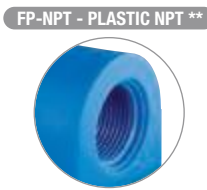

\* BSP  
parallel (cylindrical)  
ISO 228

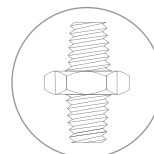

\*\* NPT  
tapered (conical)  
ANSI/ASME B1.20.1





# DOSAFOS PLUS 3P

## WORKING CONDITIONS

Max working pressure:  
 BSP versions \_\_\_\_\_ 8 bar (116 psi)  
 NPT versions \_\_\_\_\_ 8,6 bar (125 psi)  
 Max working temperature \_\_\_\_\_ 35°C (95°F)  
 Min working temperature \_\_\_\_\_ 4°C (39,2°F)  
 Max total hardness \_\_\_\_\_ 50°F (500 ppm CaCO<sub>3</sub>)

## SPECIFICATIONS

Non-toxic materials, suitable for drinking water.  
 Head and ring nut: reinforced polypropylene.  
 Bowl: PET.  
 O-ring: EPDM.  
 Breather-valve: body polypropylene, o-ring EPDM.  
 IN/OUT brass threads: CW 617 N brass.

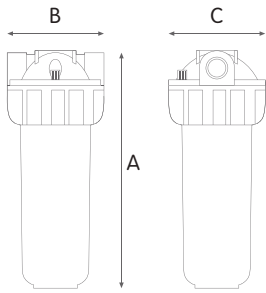

**Remark** - Water treated with polyphosphate can be heated up to a max temperature of 75° - 80°C, beyond that temperature the polyphosphate gradually loses its efficacy.

## DOSAFOS PLUS 3P SX with polyphosphate loose crystals

### HOUSINGS WITH BRASS BSP THREADS

CODE	MODEL	APPLICABLE REFILL	g*	IN/OUT	DIMENSIONS mm		
					A	B	C
RA404T811	DOSAFOS MEDIUM PLUS 3P MFO SX	LOOSE CRYSTALS	650	1/2"	191	133	130
RA404T831	DOSAFOS MEDIUM PLUS 3P AFO SX	LOOSE CRYSTALS	650	3/4"	191	133	130
RA404T851	DOSAFOS MEDIUM PLUS 3P BFO SX	LOOSE CRYSTALS	650	1"	197	145	130
RA404T911	DOSAFOS JUNIOR PLUS 3P MFO SX	LOOSE CRYSTALS	1050	1/2"	241	133	130
RA404T931	DOSAFOS JUNIOR PLUS 3P AFO SX	LOOSE CRYSTALS	1050	3/4"	241	133	130
RA404T951	DOSAFOS JUNIOR PLUS 3P BFO SX	LOOSE CRYSTALS	1050	1"	247	145	130
RA404T111	DOSAFOS SENIOR PLUS 3P MFO SX	LOOSE CRYSTALS	1550	1/2"	315	133	130
RA404T131	DOSAFOS SENIOR PLUS 3P AFO SX	LOOSE CRYSTALS	1550	3/4"	315	133	130
RA404T151	DOSAFOS SENIOR PLUS 3P BFO SX	LOOSE CRYSTALS	1550	1"	321	145	130

g\* = polyphosphate crystals amount in grams



### HOUSINGS WITH PLASTIC BSP THREADS

CODE	MODEL	APPLICABLE REFILL	g*	IN/OUT	DIMENSIONS mm		
					A	B	C
RA404T821	DOSAFOS MEDIUM PLUS 3P MFP SX	LOOSE CRYSTALS	650	1/2"	191	133	130
RA404T841	DOSAFOS MEDIUM PLUS 3P AFP SX	LOOSE CRYSTALS	650	3/4"	191	133	130
RA404T861	DOSAFOS MEDIUM PLUS 3P BFP SX	LOOSE CRYSTALS	650	1"	197	145	130
RA404T921	DOSAFOS JUNIOR PLUS 3P MFP SX	LOOSE CRYSTALS	1050	1/2"	241	133	130
RA404T941	DOSAFOS JUNIOR PLUS 3P AFP SX	LOOSE CRYSTALS	1050	3/4"	241	133	130
RA404T961	DOSAFOS JUNIOR PLUS 3P BFP SX	LOOSE CRYSTALS	1050	1"	247	145	130
RA404T121	DOSAFOS SENIOR PLUS 3P MFP SX	LOOSE CRYSTALS	1550	1/2"	315	133	130
RA404T141	DOSAFOS SENIOR PLUS 3P AFP SX	LOOSE CRYSTALS	1550	3/4"	315	133	130
RA404T161	DOSAFOS SENIOR PLUS 3P BFP SX	LOOSE CRYSTALS	1550	1"	321	145	130



### HOUSINGS WITH PLASTIC NPT THREADS

CODE	MODEL	APPLICABLE REFILL	g*	IN/OUT	DIMENSIONS mm		
					A	B	C
RA404T842	DOSAFOS MEDIUM PLUS 3P AFP NPT SX	LOOSE CRYSTALS	650	3/4"	191	133	130
RA404T862	DOSAFOS MEDIUM PLUS 3P BFP NPT SX	LOOSE CRYSTALS	650	1"	197	145	130
RA404T942	DOSAFOS JUNIOR PLUS 3P AFP NPT SX	LOOSE CRYSTALS	1050	3/4"	241	133	130
RA404T962	DOSAFOS JUNIOR PLUS 3P BFP NPT SX	LOOSE CRYSTALS	1050	1"	247	145	130
RA404T142	DOSAFOS SENIOR PLUS 3P AFP NPT SX	LOOSE CRYSTALS	1550	3/4"	315	133	130
RA404T162	DOSAFOS SENIOR PLUS 3P BFP NPT SX	LOOSE CRYSTALS	1550	1"	321	145	130

g\* = polyphosphate crystals amount in grams



### HOUSINGS WITH PLASTIC BSP THREADS

CODE	MODEL	APPLICABLE REFILL	g*	IN/OUT	DIMENSIONS mm		
					A	B	C
RA404T825	DOSAFOS MEDIUM PLUS 3P MMP SX	LOOSE CRYSTALS	650	1/2"	191	175	130
RA404T845	DOSAFOS MEDIUM PLUS 3P AMP SX	LOOSE CRYSTALS	650	3/4"	191	175	130
RA404T865	DOSAFOS MEDIUM PLUS 3P BMP SX	LOOSE CRYSTALS	650	1"	197	175	130
RA404T925	DOSAFOS JUNIOR PLUS 3P MMP SX	LOOSE CRYSTALS	1050	1/2"	241	175	130
RA404T945	DOSAFOS JUNIOR PLUS 3P AMP SX	LOOSE CRYSTALS	1050	3/4"	241	175	130
RA404T965	DOSAFOS JUNIOR PLUS 3P BMP SX	LOOSE CRYSTALS	1050	1"	247	175	130
RA404T125	DOSAFOS SENIOR PLUS 3P MMP SX	LOOSE CRYSTALS	1550	1/2"	315	175	130
RA404T145	DOSAFOS SENIOR PLUS 3P AMP SX	LOOSE CRYSTALS	1550	3/4"	315	175	130
RA404T165	DOSAFOS SENIOR PLUS 3P BMP SX	LOOSE CRYSTALS	1550	1"	321	175	130

g\* = polyphosphate crystals amount in grams

Some items in the list are subject to minimum order quantities and/or to longer delivery term.



# DOSAFOS PLUS 3P HA

## WORKING CONDITIONS

Max working pressure:  
 BSP versions \_\_\_\_\_ 8 bar (116 psi)  
 NPT versions \_\_\_\_\_ 8,6 bar (125 psi)  
 Max working temperature \_\_\_\_\_ 35°C (95°F)  
 Min working temperature \_\_\_\_\_ 4°C (39,2°F)  
 Max total hardness \_\_\_\_\_ 50°F (500 ppm CaCO<sub>3</sub>)

## SPECIFICATIONS

Non-toxic materials, suitable for drinking water.  
 Head and ring nut: reinforced polypropylene.  
 Bowl: PET.  
 O-ring: EPDM.  
 Breather-valve: body polypropylene, o-ring EPDM.  
 IN/OUT brass threads: CW 617 N brass.

**Remark** - Water treated with polyphosphate can be heated up to a max temperature of 75° - 80°C, beyond that temperature the polyphosphate gradually loses its efficacy.

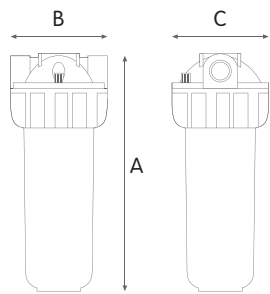

## DOSAFOS PLUS 3P SX HA with HA polyphosphate crystals cartridge

### HOUSINGS WITH BRASS BSP THREADS

CODE	MODEL	SUITABLE CARTRIDGE	IN/OUT	DIMENSIONS mm		
				A	B	C
RA404T814	DOSAFOS MEDIUM PLUS 3P MFO SX + HA	HA 5" SX CARTRIDGE	1/2"	191	133	130
RA404T834	DOSAFOS MEDIUM PLUS 3P AFO SX + HA	HA 5" SX CARTRIDGE	3/4"	191	133	130
RA404T854	DOSAFOS MEDIUM PLUS 3P BFO SX + HA	HA 5" SX CARTRIDGE	1"	197	145	130
RA404T914	DOSAFOS JUNIOR PLUS 3P MFO SX + HA	HA 7" SX CARTRIDGE	1/2"	241	133	130
RA404T934	DOSAFOS JUNIOR PLUS 3P AFO SX + HA	HA 7" SX CARTRIDGE	3/4"	241	133	130
RA404T954	DOSAFOS JUNIOR PLUS 3P BFO SX + HA	HA 7" SX CARTRIDGE	1"	247	145	130
RA404T114	DOSAFOS SENIOR PLUS 3P MFO SX + HA	HA 10" SX CARTRIDGE	1/2"	315	133	130
RA404T134	DOSAFOS SENIOR PLUS 3P AFO SX + HA	HA 10" SX CARTRIDGE	3/4"	315	133	130
RA404T154	DOSAFOS SENIOR PLUS 3P BFO SX + HA	HA 10" SX CARTRIDGE	1"	321	145	130

### HOUSINGS WITH PLASTIC BSP THREADS

CODE	MODEL	SUITABLE CARTRIDGE	IN/OUT	DIMENSIONS mm		
				A	B	C
RA404T823	DOSAFOS MEDIUM PLUS 3P MFP SX + HA	HA 5" SX CARTRIDGE	1/2"	191	133	130
RA404T843	DOSAFOS MEDIUM PLUS 3P AFP SX + HA	HA 5" SX CARTRIDGE	3/4"	191	133	130
RA404T863	DOSAFOS MEDIUM PLUS 3P BFP SX + HA	HA 5" SX CARTRIDGE	1"	197	145	130
RA404T923	DOSAFOS JUNIOR PLUS 3P MFP SX + HA	HA 7" SX CARTRIDGE	1/2"	241	133	130
RA404T943	DOSAFOS JUNIOR PLUS 3P AFP SX + HA	HA 7" SX CARTRIDGE	3/4"	241	133	130
RA404T963	DOSAFOS JUNIOR PLUS 3P BFP SX + HA	HA 7" SX CARTRIDGE	1"	247	145	130
RA404T120	DOSAFOS SENIOR PLUS 3P MFP SX + HA	HA 10" SX CARTRIDGE	1/2"	315	133	130
RA404T143	DOSAFOS SENIOR PLUS 3P AFP SX + HA	HA 10" SX CARTRIDGE	3/4"	315	133	130
RA404T163	DOSAFOS SENIOR PLUS 3P BFP SX + HA	HA 10" SX CARTRIDGE	1"	321	145	130

### HOUSINGS WITH PLASTIC NPT THREADS

CODE	MODEL	SUITABLE CARTRIDGE	IN/OUT	DIMENSIONS mm		
				A	B	C
RA404T844	DOSAFOS MEDIUM PLUS 3P AFP NPT SX + HA	HA 5" SX CARTRIDGE	3/4"	191	133	130
RA404T864	DOSAFOS MEDIUM PLUS 3P BFP NPT SX + HA	HA 5" SX CARTRIDGE	1"	197	145	130
RA404T944	DOSAFOS JUNIOR PLUS 3P AFP NPT SX + HA	HA 7" SX CARTRIDGE	3/4"	241	133	130
RA404T964	DOSAFOS JUNIOR PLUS 3P BFP NPT SX + HA	HA 7" SX CARTRIDGE	1"	247	145	130
RA404T144	DOSAFOS SENIOR PLUS 3P AFP NPT SX + HA	HA 10" SX CARTRIDGE	3/4"	315	133	130
RA404T164	DOSAFOS SENIOR PLUS 3P BFP NPT SX + HA	HA 10" SX CARTRIDGE	1"	321	145	130

### HOUSINGS WITH PLASTIC BSP THREADS

CODE	MODEL	SUITABLE CARTRIDGE	IN/OUT	DIMENSIONS mm		
				A	B	C
RA404T826	DOSAFOS MEDIUM PLUS 3P MMP SX + HA	HA 5" SX CARTRIDGE	1/2"	191	175	130
RA404T846	DOSAFOS MEDIUM PLUS 3P AMP SX + HA	HA 5" SX CARTRIDGE	3/4"	191	175	130
RA404T866	DOSAFOS MEDIUM PLUS 3P BMP SX + HA	HA 5" SX CARTRIDGE	1"	197	175	130
RA404T926	DOSAFOS JUNIOR PLUS 3P MMP SX + HA	HA 7" SX CARTRIDGE	1/2"	241	175	130
RA404T946	DOSAFOS JUNIOR PLUS 3P AMP SX + HA	HA 7" SX CARTRIDGE	3/4"	241	175	130
RA404T966	DOSAFOS JUNIOR PLUS 3P BMP SX + HA	HA 7" SX CARTRIDGE	1"	247	175	130
RA404T126	DOSAFOS SENIOR PLUS 3P MMP SX + HA	HA 10" SX CARTRIDGE	1/2"	315	175	130
RA404T146	DOSAFOS SENIOR PLUS 3P AMP SX + HA	HA 10" SX CARTRIDGE	3/4"	315	175	130
RA404T166	DOSAFOS SENIOR PLUS 3P BMP SX + HA	HA 10" SX CARTRIDGE	1"	321	175	130

Some items in the list are subject to minimum order quantities and/or to longer delivery term.





# DOSAFOS PLUS 2P

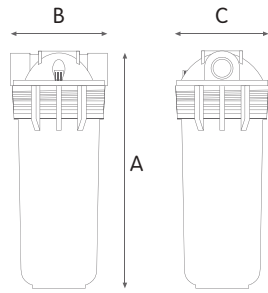

## WORKING CONDITIONS

Max working pressure \_\_\_\_\_ 8 bar (116 psi)  
 Max working temperature \_\_\_\_\_ 35°C (95°F)  
 Min working temperature \_\_\_\_\_ 4°C (39,2°F)  
 Max total hardness \_\_\_\_\_ 50°F (500 ppm CaCO<sub>3</sub>)

**Remark** - Water treated with polyphosphate can be heated up to a max temperature of 75° - 80°C, beyond that temperature the polyphosphate gradually loses its efficacy.

## SPECIFICATIONS

Non-toxic materials, suitable for drinking water.  
 Head: reinforced polypropylene.  
 Bowl: SAN.  
 O-ring: EPDM.  
 Breather-valve: body polypropylene, o-ring EPDM.  
 IN/OUT brass threads: CW 617 N brass.

## DOSAFOS PLUS 2P SX with polyphosphate loose crystals

### HOUSINGS WITH BRASS BSP THREADS

CODE	MODEL	APPLICABLE REFILL	g*	IN/OUT	DIMENSIONS mm		
					A	B	C
RA404P712	DOSAFOS CADET PLUS 2P MFO SX	LOOSE CRYSTALS	400	1/2"	169	133	130
RA404P732	DOSAFOS CADET PLUS 2P AFO SX	LOOSE CRYSTALS	400	3/4"	169	133	130
RA404P752	DOSAFOS CADET PLUS 2P BFO SX	LOOSE CRYSTALS	400	1"	175	145	130
RA404P012	DOSAFOS JUNIOR PLUS 2P MFO SX	LOOSE CRYSTALS	950	1/2"	241	133	130
RA404P032	DOSAFOS JUNIOR PLUS 2P AFO SX	LOOSE CRYSTALS	950	3/4"	241	133	130
RA404P052	DOSAFOS JUNIOR PLUS 2P BFO SX	LOOSE CRYSTALS	950	1"	247	145	130
RA404P212	DOSAFOS SENIOR PLUS 2P MFO SX	LOOSE CRYSTALS	1500	1/2"	315	133	130
RA404P232	DOSAFOS SENIOR PLUS 2P AFO SX	LOOSE CRYSTALS	1500	3/4"	315	133	130
RA404P252	DOSAFOS SENIOR PLUS 2P BFO SX	LOOSE CRYSTALS	1500	1"	321	145	130

g\* = polyphosphate crystals amount in grams

### HOUSINGS WITH PLASTIC BSP THREADS

CODE	MODEL	APPLICABLE REFILL	g*	IN/OUT	DIMENSIONS mm		
					A	B	C
RA404P722	DOSAFOS CADET PLUS 2P MFP SX	LOOSE CRYSTALS	400	1/2"	169	133	130
RA404P742	DOSAFOS CADET PLUS 2P AFP SX	LOOSE CRYSTALS	400	3/4"	169	133	130
RA404P762	DOSAFOS CADET PLUS 2P BFP SX	LOOSE CRYSTALS	400	1"	175	145	130
RA404P022	DOSAFOS JUNIOR PLUS 2P MFP SX	LOOSE CRYSTALS	950	1/2"	241	133	130
RA404P042	DOSAFOS JUNIOR PLUS 2P AFP SX	LOOSE CRYSTALS	950	3/4"	241	133	130
RA404P062	DOSAFOS JUNIOR PLUS 2P BFP SX	LOOSE CRYSTALS	950	1"	247	145	130
RA404P122	DOSAFOS SENIOR PLUS 2P MFP SX	LOOSE CRYSTALS	1500	1/2"	315	133	130
RA404P242	DOSAFOS SENIOR PLUS 2P AFP SX	LOOSE CRYSTALS	1500	3/4"	315	133	130
RA404P262	DOSAFOS SENIOR PLUS 2P BFP SX	LOOSE CRYSTALS	1500	1"	321	145	130

### HOUSINGS WITH PLASTIC NPT THREADS

CODE	MODEL	APPLICABLE REFILL	g*	IN/OUT	DIMENSIONS mm		
					A	B	C
RA404P743	DOSAFOS CADET PLUS 2P AFP NPT SX	LOOSE CRYSTALS	400	3/4"	169	133	130
RA404P763	DOSAFOS CADET PLUS 2P BFP NPT SX	LOOSE CRYSTALS	400	1"	175	145	130
RA404P043	DOSAFOS JUNIOR PLUS 2P AFP NPT SX	LOOSE CRYSTALS	950	3/4"	241	133	130
RA404P063	DOSAFOS JUNIOR PLUS 2P BFP NPT SX	LOOSE CRYSTALS	950	1"	247	145	130
RA404P243	DOSAFOS SENIOR PLUS 2P AFP NPT SX	LOOSE CRYSTALS	1500	3/4"	315	133	130
RA404P263	DOSAFOS SENIOR PLUS 2P BFP NPT SX	LOOSE CRYSTALS	1500	1"	321	145	130

g\* = polyphosphate crystals amount in grams

### HOUSINGS WITH PLASTIC BSP THREADS

CODE	MODEL	APPLICABLE REFILL	g*	IN/OUT	DIMENSIONS mm		
					A	B	C
RA404P725	DOSAFOS CADET PLUS 2P MMP SX	LOOSE CRYSTALS	400	1/2"	169	175	130
RA404P745	DOSAFOS CADET PLUS 2P AMP SX	LOOSE CRYSTALS	400	3/4"	169	175	130
RA404P765	DOSAFOS CADET PLUS 2P BMP SX	LOOSE CRYSTALS	400	1"	175	175	130
RA404P026	DOSAFOS JUNIOR PLUS 2P MMP SX	LOOSE CRYSTALS	950	1/2"	241	175	130
RA404P046	DOSAFOS JUNIOR PLUS 2P AMP SX	LOOSE CRYSTALS	950	3/4"	241	175	130
RA404P066	DOSAFOS JUNIOR PLUS 2P BMP SX	LOOSE CRYSTALS	950	1"	247	175	130
RA404P125	DOSAFOS SENIOR PLUS 2P MMP SX	LOOSE CRYSTALS	1500	1/2"	315	175	130
RA404P145	DOSAFOS SENIOR PLUS 2P AMP SX	LOOSE CRYSTALS	1500	3/4"	315	175	130
RA404P165	DOSAFOS SENIOR PLUS 2P BMP SX	LOOSE CRYSTALS	1500	1"	321	175	130

g\* = polyphosphate crystals amount in grams

Some items in the list are subject to minimum order quantities and/or to longer delivery term.



# DOSAFOS PLUS 2P HA

## WORKING CONDITIONS

Max working pressure \_\_\_\_\_ 8 bar (116 psi)  
 Max working temperature \_\_\_\_\_ 35°C (95°F)  
 Min working temperature \_\_\_\_\_ 4°C (39,2°F)  
 Max total hardness \_\_\_\_\_ 50°F (500 ppm CaCO<sub>3</sub>)

**Remark** - Water treated with polyphosphate can be heated up to a max temperature of 75° - 80°C, beyond that temperature the polyphosphate gradually loses its efficacy.

## SPECIFICATIONS

Non-toxic materials, suitable for drinking water.  
 Head: reinforced polypropylene.  
 Bowl: SAN.  
 O-ring: EPDM.  
 Breather-valve: body polypropylene, o-ring EPDM.  
 IN/OUT brass threads: CW 617 N brass.

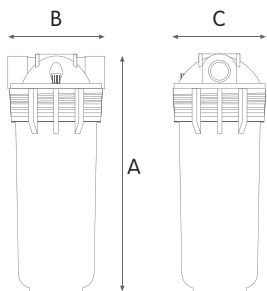

## DOSAFOS PLUS 2P SX HA with HA polyphosphate crystals cartridge

### HOUSINGS WITH BRASS BSP THREADS

CODE	MODEL	SUITABLE CARTRIDGE	IN/OUT	DIMENSIONS mm		
				A	B	C
RA404P014	DOSAFOS JUNIOR PLUS 2P MFO SX + HA	HA 7" SX CARTRIDGE	1/2"	241	133	130
RA404P034	DOSAFOS JUNIOR PLUS 2P AFO SX + HA	HA 7" SX CARTRIDGE	3/4"	241	133	130
RA404P054	DOSAFOS JUNIOR PLUS 2P BFO SX + HA	HA 7" SX CARTRIDGE	1"	247	145	130
RA404P214	DOSAFOS SENIOR PLUS 2P MFO SX + HA	HA 10" SX CARTRIDGE	1/2"	315	133	130
RA404P234	DOSAFOS SENIOR PLUS 2P AFO SX + HA	HA 10" SX CARTRIDGE	3/4"	315	133	130
RA404P254	DOSAFOS SENIOR PLUS 2P BFO SX + HA	HA 10" SX CARTRIDGE	1"	321	145	130

### HOUSINGS WITH PLASTIC BSP THREADS

CODE	MODEL	SUITABLE CARTRIDGE	IN/OUT	DIMENSIONS mm		
				A	B	C
RA404P024	DOSAFOS JUNIOR PLUS 2P MFP SX + HA	HA 7" SX CARTRIDGE	1/2"	241	133	130
RA404P044	DOSAFOS JUNIOR PLUS 2P AFP SX + HA	HA 7" SX CARTRIDGE	3/4"	241	133	130
RA404P064	DOSAFOS JUNIOR PLUS 2P BFP SX + HA	HA 7" SX CARTRIDGE	1"	247	145	130
RA404P124	DOSAFOS SENIOR PLUS 2P MFP SX + HA	HA 10" SX CARTRIDGE	1/2"	315	133	130
RA404P244	DOSAFOS SENIOR PLUS 2P AFP SX + HA	HA 10" SX CARTRIDGE	3/4"	315	133	130
RA404P264	DOSAFOS SENIOR PLUS 2P BFP SX + HA	HA 10" SX CARTRIDGE	1"	321	145	130

### HOUSINGS WITH PLASTIC NPT THREADS

CODE	MODEL	SUITABLE CARTRIDGE	IN/OUT	DIMENSIONS mm		
				A	B	C
RA404P045	DOSAFOS JUNIOR PLUS 2P AFP NPT SX + HA	HA 7" SX CARTRIDGE	3/4"	241	133	130
RA404P065	DOSAFOS JUNIOR PLUS 2P BFP NPT SX + HA	HA 7" SX CARTRIDGE	1"	247	145	130
RA404P245	DOSAFOS SENIOR PLUS 2P AFP NPT SX + HA	HA 10" SX CARTRIDGE	3/4"	315	133	130
RA404P265	DOSAFOS SENIOR PLUS 2P BFP NPT SX + HA	HA 10" SX CARTRIDGE	1"	321	145	130

### HOUSINGS WITH PLASTIC BSP THREADS

CODE	MODEL	SUITABLE CARTRIDGE	IN/OUT	DIMENSIONS mm		
				A	B	C
RA404P027	DOSAFOS JUNIOR PLUS 2P MMP SX + HA	HA 7" SX CARTRIDGE	1/2"	241	175	130
RA404P047	DOSAFOS JUNIOR PLUS 2P AMP SX + HA	HA 7" SX CARTRIDGE	3/4"	241	175	130
RA404P067	DOSAFOS JUNIOR PLUS 2P BMP SX + HA	HA 7" SX CARTRIDGE	1"	247	175	130
RA404P126	DOSAFOS SENIOR PLUS 2P MMP SX + HA	HA 10" SX CARTRIDGE	1/2"	315	175	130
RA404P146	DOSAFOS SENIOR PLUS 2P AMP SX + HA	HA 10" SX CARTRIDGE	3/4"	315	175	130
RA404P166	DOSAFOS SENIOR PLUS 2P BMP SX + HA	HA 10" SX CARTRIDGE	1"	321	175	130

Some items in the list are subject to minimum order quantities and/or to longer delivery term.



# DOSAFOS MIGNON PLUS 3P

## WORKING CONDITIONS

Max working pressure \_\_\_\_\_ 8 bar (116 psi)  
 Max working temperature \_\_\_\_\_ 35°C (95°F)  
 Min working temperature \_\_\_\_\_ 4°C (39,2°F)  
 Max total hardness \_\_\_\_\_ 50°F (500 ppm CaCO<sub>3</sub>)

## SPECIFICATIONS

Non-toxic materials, suitable for drinking water.  
 Head / ring nut: reinforced polypropylene.  
 Bowl: SAN.  
 O-ring: EPDM.  
 IN/OUT brass threads: CW 617 N brass.

**Remark** - Water treated with polyphosphate can be heated up to a max temperature of 75° - 80°C, beyond that temperature the polyphosphate gradually loses its efficacy.

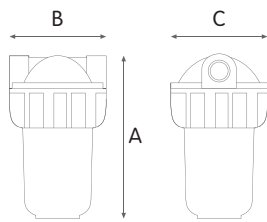

## 2 PORTS HEADS

### DOSAFOS MIGNON PLUS 3P with polyphosphate loose crystals

#### HOUSINGS WITH BRASS BSP THREADS

CODE	MODEL	APPLICABLE REFILL	g*	IN/OUT	DIMENSIONS mm		
					A	B	C
RA404P511	DOSAFOS MIGNON PLUS L3P MFO	LOOSE CRYSTALS	265	1/2"	176	94	89
RA404P531	DOSAFOS MIGNON PLUS L3P AFO	LOOSE CRYSTALS	265	3/4"	178	94	89
RA403P511	DOSAFOS MIGNON PLUS S3P MFO	LOOSE CRYSTALS	265	1/2"	177	90	89

g\* = polyphosphate crystals amount in grams



### DOSAFOS MIGNON PLUS 3P with HA polyphosphate crystals cartridge

#### HOUSINGS WITH BRASS BSP THREADS

CODE	MODEL	SUITABLE CARTRIDGE	IN/OUT	DIMENSIONS mm		
				A	B	C
RA403P524	DOSAFOS MIGNON PLUS L3P MFO+ HA	HA 5" M SX CARTRIDGE	1/2"	176	94	89
RA404P534	DOSAFOS MIGNON PLUS L3P AFO + HA	HA 5" M SX CARTRIDGE	3/4"	178	94	89
RA403P514	DOSAFOS MIGNON PLUS S3P MFO + HA	HA 5" M SX CARTRIDGE	1/2"	177	90	89

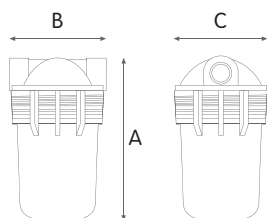

# DOSAFOS MIGNON PLUS 2P

### DOSAFOS MIGNON PLUS 2P with polyphosphate loose crystals

#### HOUSINGS WITH BRASS BSP THREADS

CODE	MODEL	APPLICABLE REFILL	g*	IN/OUT	DIMENSIONS mm		
					A	B	C
RA404P612	DOSAFOS MIGNON PLUS L2P MFO	LOOSE CRYSTALS	275	1/2"	176	94	89
RA404P622	DOSAFOS MIGNON PLUS L2P AFO	LOOSE CRYSTALS	275	3/4"	178	94	89
RA403P612	DOSAFOS MIGNON PLUS S2P MFO	LOOSE CRYSTALS	275	1/2"	177	90	89

g\* = polyphosphate crystals amount in grams



### DOSAFOS MIGNON PLUS 2P with HA polyphosphate crystals cartridge

#### HOUSINGS WITH BRASS BSP THREADS

CODE	MODEL	SUITABLE CARTRIDGE	IN/OUT	DIMENSIONS mm		
				A	B	C
RA403P624	DOSAFOS MIGNON PLUS L2P MFO + HA	HA 5" M SX CARTRIDGE	1/2"	176	94	89
RA403P622	DOSAFOS MIGNON PLUS L2P AFO + HA	HA 5" M SX CARTRIDGE	3/4"	178	94	89
RA403P614	DOSAFOS MIGNON PLUS S2P MFO + HA	HA 5" M SX CARTRIDGE	1/2"	177	90	89





# DOSAFOS MIGNON PLUS SL

## WORKING CONDITIONS

Max working pressure \_\_\_\_\_ 8 bar (116 psi)  
 Max working temperature \_\_\_\_\_ 35°C (95°F)  
 Min working temperature \_\_\_\_\_ 4°C (39,2°F)  
 Max total hardness \_\_\_\_\_ 50°F (500 ppm CaCO<sub>3</sub>)

## SPECIFICATIONS

Non-toxic materials, suitable for drinking water.  
 Head / ring nut: reinforced polypropylene.  
 Bowl: SAN.  
 O-ring: EPDM.  
 IN/OUT brass threads: CW 617 N brass.

**Remark** - Water treated with polyphosphate can be heated up to a max temperature of 75° - 80°C, beyond that temperature the polyphosphate gradually loses its efficacy.

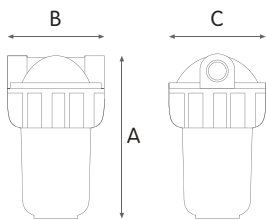

## 3 PORTS HEADS

### DOSAFOS MIGNON PLUS 3P with polyphosphate loose crystals

#### HOUSINGS WITH BRASS BSP THREADS

CODE	MODEL	APPLICABLE REFILL	g*	IN/OUT	DIMENSIONS mm		
					A	B	C
RA404P411	DOSAFOS MIGNON PLUS SL3P MFO	LOOSE CRYSTALS	265	1/2"	187	92	83

g\* = polyphosphate crystals amount in grams



### DOSAFOS MIGNON PLUS 3P with HA polyphosphate crystals cartridge

#### HOUSINGS WITH BRASS BSP THREADS

CODE	MODEL	SUITABLE CARTRIDGE	IN/OUT	DIMENSIONS mm		
				A	B	C
RA404P414	DOSAFOS MIGNON PLUS SL3P MFO + HA	HA 5" M SX CARTRIDGE	1/2"	187	92	83

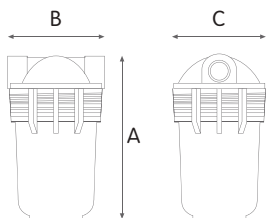

### DOSAFOS MIGNON PLUS 2P with polyphosphate loose crystals

#### HOUSINGS WITH BRASS BSP THREADS

CODE	MODEL	APPLICABLE REFILL	g*	IN/OUT	DIMENSIONS mm		
					A	B	C
RA403P414	DOSAFOS MIGNON PLUS SL2P MFO	LOOSE CRYSTALS	275	1/2"	192	92	83

g\* = polyphosphate crystals amount in grams



### DOSAFOS MIGNON PLUS 2P with HA polyphosphate crystals cartridge

#### HOUSINGS WITH BRASS BSP THREADS

CODE	MODEL	SUITABLE CARTRIDGE	IN/OUT	DIMENSIONS mm		
				A	B	C
RA403P424	DOSAFOS MIGNON PLUS SL2P MFO + HA	HA 5" M SX CARTRIDGE	1/2"	192	92	83





# DOSAL

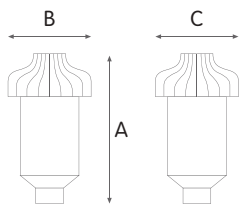

### WORKING CONDITIONS

Max working pressure \_\_\_\_\_ 7 bar (101 psi)  
 Max working temperature \_\_\_\_\_ 35°C (95°F)  
 Min working temperature \_\_\_\_\_ 4°C (39,2°F)  
 Max total hardness \_\_\_\_\_ 50°F (500 ppm CaCO<sub>3</sub>)

**Remark** - Water treated with polyphosphate can be heated up to a max temperature of 75° - 80°C, beyond that temperature the polyphosphate gradually loses its efficacy.

### SPECIFICATIONS

Non-toxic materials.  
 Head: reinforced polypropylene.  
 Bowl: SAN.  
 O-ring: EPDM.  
 Flat seals: NBR.  
 Treating material: polyphosphate crystals.

DOSAL is a non-proportional dosing systems designed for the protection of washing-machines against the calcareous incrustations of the heater, saving energy, reducing powders consumption and providing "spotless" aesthetic effect on items. DOSAL is designed for easy installation to standard water supply of washing machines, no plumbing required.



### DOSAL for washing machine

#### POLYPHOSPHATE CRYSTALS DOSING SYSTEMS

CODE	MODEL	APPLICABLE REFILL	IN/OUT	DIMENSIONS mm		
				A	B	C
RA402P442	DOSAL	LOOSE CRYSTAL 6/10	3/4"	130	68	68



**POLYPHOSPHATE CRYSTALS 6/10** (small)  
 160 g blister, refill TO DOSAL.

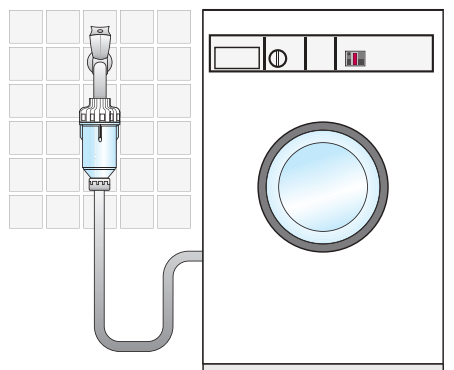



# MAG

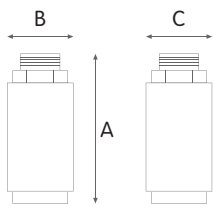

## WORKING CONDITIONS

Max working pressure \_\_\_\_\_ 10 bar (145 psi)  
 Max working temperature \_\_\_\_\_ 90°C (194°F)  
 Min working temperature \_\_\_\_\_ 4°C (39,2°F)  
 Max total hardness \_\_\_\_\_ 35°F (350 ppm CaCO<sub>3</sub>)

**Remark** - Water treated can be heated up to a max temperature of 90°C, beyond that temperature the conditioning gradually loses its efficacy.

## SPECIFICATIONS

Non-toxic materials, suitable for drinking water.  
 Body MAG MF and MAG MM: CW 614 N brass chromium-plated.  
 Body MAG FF: aluminium.  
 Magnets: neodymium.  
 Magnetic induction: 12.800 GAUSS.

Magnetic conditioning of hard water provides anti-scale protection by making the carbonates unable to deposit and form incrustation on water heaters and pipes, thus reducing energy consumption and prolonging the lifetime of appliances. MAG is a range of magnetic conditioners made of chrome-plated brass and neodymium magnets with magnetic induction up to 12800 gauss.



## MAG MF magnetic anti-scale conditioners

### WITH IN/OUT THREADS MALE/FEMALE

CODE	MODEL	IN/OUT	DIMENSIONS mm		
			A	B	C
RE6115000	Micro MAG MF	1/8"	56	30	30
RE6115001	MAG 1 MF complete with two seals	1/2"	57	28	28
RE6115002	MAG 2 MF complete with two seals	3/4"	57	30	30



## MAG MM magnetic anti-scale conditioners

### WITH IN/OUT THREADS MALE/MALE

CODE	MODEL	IN/OUT	DIMENSIONS mm		
			A	B	C
RE6115003	MAG 3 MM	1"	89	50	50
RE6115011	MAG 11 MM	1"1/4	135	80	80
RE6115012	MAG 12 MM	1"1/2	135	80	80
RE6115013	MAG 13 MM	2"	135	80	80



## MAG FF magnetic anti-scale conditioners

### WITH IN/OUT THREADS FEMALE/FEMALE

CODE	MODEL	IN/OUT	DIMENSIONS mm		
			A	B	C
RE6115103	MAG 3 FF	1"	135	80	80
RE6115111	MAG 11 FF	1"1/4	135	80	80
RE6115112	MAG 12 FF	1"1/2	135	80	80
RE6115113	MAG 13 FF	2"	135	80	80

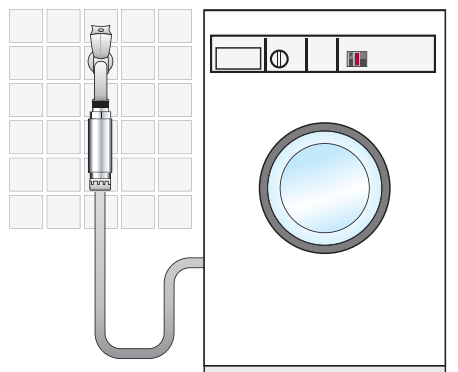







# SOFTENERS and MEDIA FILTERS

techno equipments

# JUPITER

## SOFTENERS

The water for drinking, sanitary or technological use, coming from the water system or from an autonomous supply, can be particularly hard, that is it can have a high concentration of calcium and magnesium salts. Precipitating, these salts create scaling, damage boilers, kettles, water systems and domestic appliances in general.

The JUPITER series water softeners by ATLAS FILTRI are made in compliance with the laws and regulations in force and make it possible to lower hardness with great benefits and savings in:

- sanitary hot and cold drinking water circuits
- hot water heating system boilers and their relative circuits
- steam boilers and their relative circuits as well as condensate return
- cooling and refrigerated water systems
- evaporative towers
- civil and industrial washing machines and dishwashers, launderettes
- process water for raw materials and unfinished products
- process water for the production of food, pharmaceutical and cosmetic products

The JUPITER Series water softeners offer hygienic-sanitary advantages (softer and cleaner laundry, greater detergent saving and longer clothing life).

The JUPITER water softeners utilize the exchange of calcium (Ca) and magnesium (Mg) ions with sodium (Na) ions, making the water to be softened flow on a strong cationic resin bed.

The resin is rich in sodium ions; the hard water is filtered and the ions responsible for the calcium and magnesium scaling are held on the surface of the resin and replaced with sodium ions, whose salts do not cause any deposits.

To ensure the treatment is effective, regenerate the filtering bed at regular intervals with an NaCl (brine) solution. This is done automatically by the multi-function controlling head, controlled by an electronic displacement timer/control. To be used in hot and cold sanitary drinking water circuits, the water softeners can be fitted with a by-pass and automatic resin-disinfection device (chlorine producer).

Non-toxic materials, suitable for drinking water.

- Control-valve: NORYL
- Tank: glass-fibre reinforced polyethylene
- Brine tank and cabinet: polyethylene
- Treating material: strong cationic ion-exchange resin

**Remark:** material for regeneration (NaCl) not provided with the softener.

**REFILL:** Strong cationic resin, package of 25 litres.

### WORKING CONDITIONS

Max working pressure.....	6 bar
Min working pressure.....	2 bar
Max working temperature.....	50°C
Max concentration Fe.....	0,1 ppm
Max concentration free Cl.....	0,5 ppm
Electrical functioning.....	12V
Electrical absorption.....	8W

## GUIDE TO THE CHOICE OF MODEL

JUPITER SOFTENERS		WATER HARDNESS IN °f AND IN ppm				
NUMBER OF USERS	WATER CONSUMPTION litres/day	15-25°f	26-35°f	36-45°f	46-55°f	56-65°f
		152-250 ppm	260-350 ppm	360-450 ppm	460-550 ppm	560-650 ppm
2	500	JUPITER 10	JUPITER 10	JUPITER 10	JUPITER 15	JUPITER 15
3 - 5	750 - 1250	JUPITER 15	JUPITER 30	JUPITER 30	JUPITER 30	JUPITER 50
6 - 10	1500 - 2500	JUPITER 30	JUPITER 50	JUPITER 50	JUPITER 70	JUPITER 70
11 - 15	2750 - 3750	JUPITER 50	JUPITER 70	JUPITER 70	JUPITER 100	JUPITER 120
16 - 20	4000 - 5000	JUPITER 50	JUPITER 70	JUPITER 100		
21 - 25	4250 - 6250	JUPITER 70	JUPITER 100	JUPITER 120		

## ACCESSORY INCLUDED



total hardness drops

## ACCESSORIES ON DEMAND



manual by-pass for 263/268 valve CODE EA1015037

manual by-pass for 255 valve CODE EA1015038



ATL chlorinator kit (electrodes) for disinfection of resins  
CODE EA1015500

## TECHNICAL FEATURES

Microprocessor dedicated electronics with the following characteristics:

- easily programmed display with dedicated keyboard
- disinfection system management (optional) during regeneration
- possible manual start of the regeneration process with guided progression through the various phases
- display of the regeneration phases and their duration
- memory autonomy up to 10 days (if the power supply is lacking)
- unit safety voltage 12V/50Hz

## CERTIFICATIONS



The products are tested and certified under the most stringent procedures worldwide, in compliance with DM 25 (Italy) and with the sanitary certification EAC/Ghostreghistrizia (Russia).

## SYMBOLS LEGEND



For domestic use



For technical and industrial use

INSTALLATION SCHEME

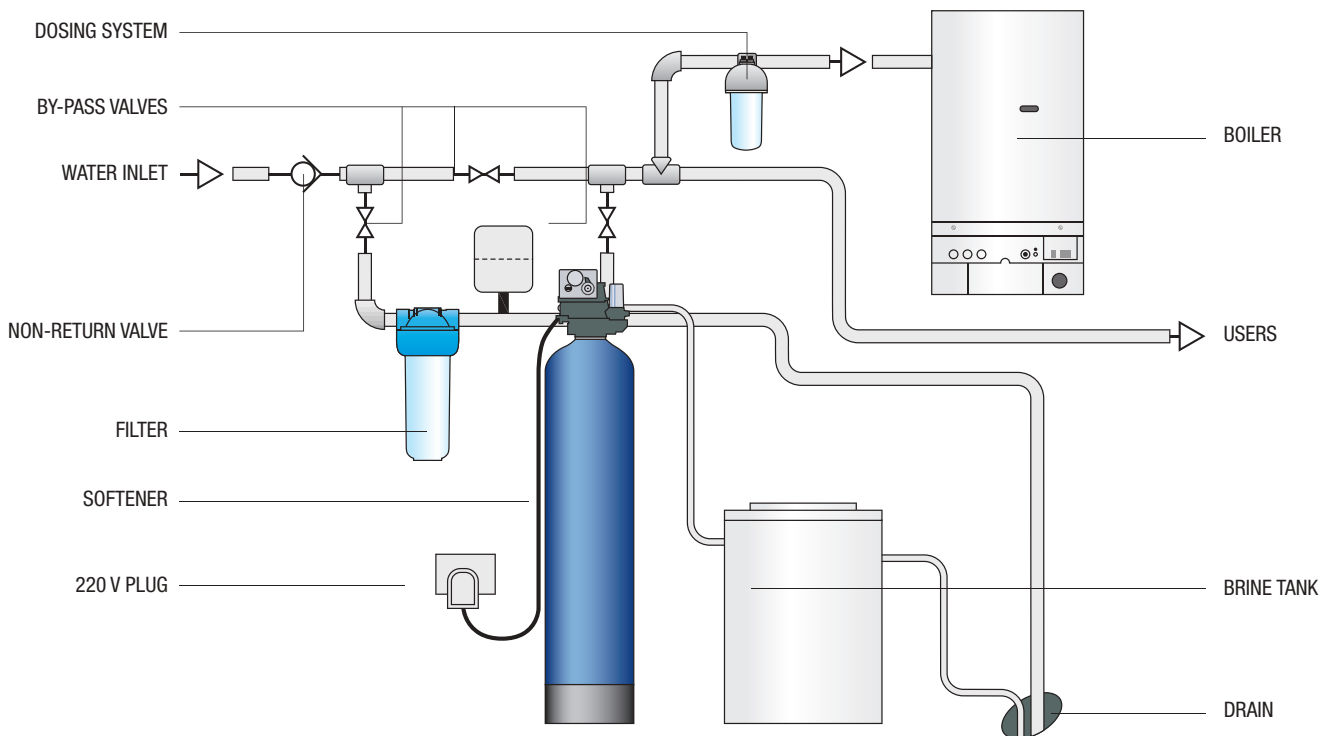
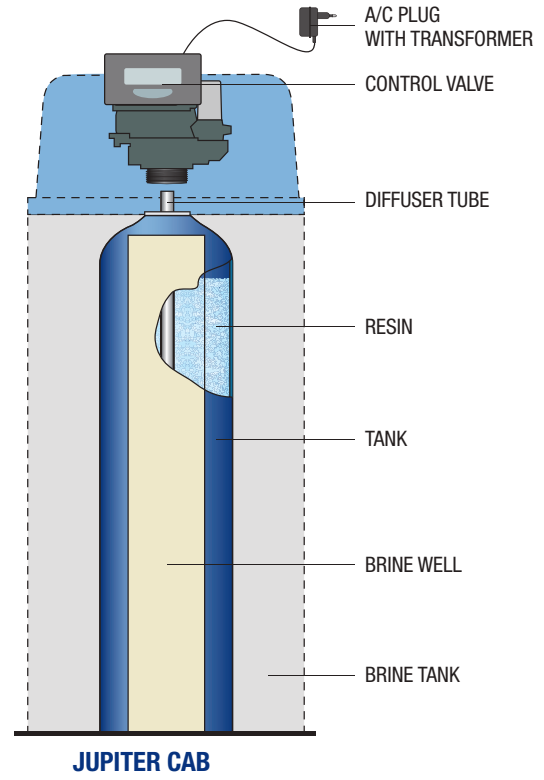
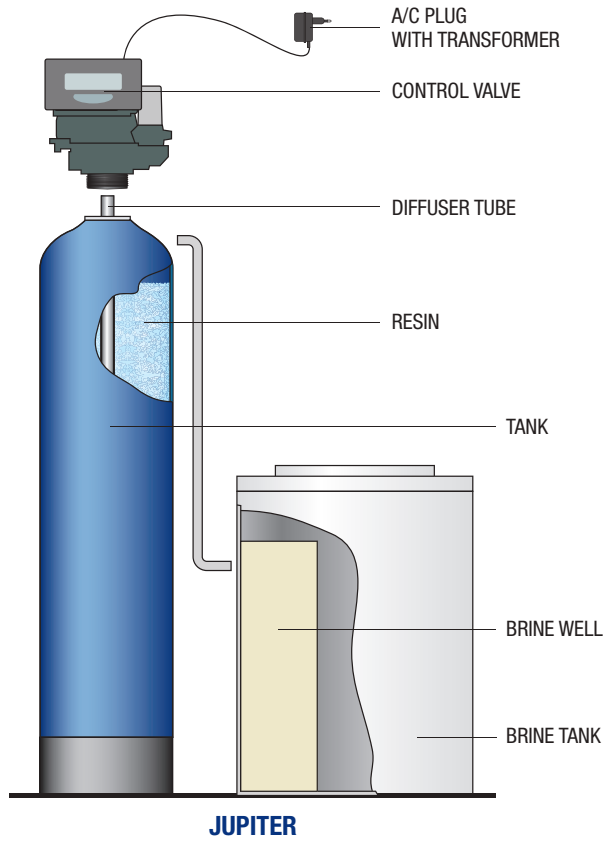



# JUPITER CAB

- Compact version where the resin tank and brine tank are in one single unit. For small capacities, they make up an elegant and small solution to soften water for domestic use.

\* The flow and cycle capacity data are calculated using 30°F (300 ppm CaCO<sub>3</sub>) supply water, with a TDS of 500 ppm and a temperature of 20°C.



## JUPITER CAB ATL

### WITH TIMER CONTROL VALVE

CODE	MODEL	AUTOTROL VALVE	IN/OUT	RESIN [l]	CYCLE CAPACITY* [m <sup>3</sup> x °f]	BRINE CONSUMPTION [kg]	FLOW RATE* [m <sup>3</sup> /h]	MAX FLOW RATE* [m <sup>3</sup> /h]	BACK-WASH FLOW RATE [m <sup>3</sup> /h]
EA1000001	JUPITER CAB 05 ATL - MINICAB	LOGIX 255/740	3/4"	4,5	25	0,75	0,4	0,6	0,4
EA1000002	JUPITER CAB 10 ATL	LOGIX 255/740	3/4"	10	60	1,5	1,1	1,5	0,4
EA1000003	JUPITER CAB 15 ATL	LOGIX 255/740	3/4"	15	90	2,25	0,9	1,1	0,3
EA1000004	JUPITER CAB 30 ATL	LOGIX 255/740	3/4"	30	180	4,5	1,8	2,3	0,6

## JUPITER CAB AVL

### WITH VOLUMETRIC CONTROL VALVE

CODE	MODEL	AUTOTROL VALVE	IN/OUT	RESIN [l]	CYCLE CAPACITY* [m <sup>3</sup> x °f]	BRINE CONSUMPTION [kg]	FLOW RATE* [m <sup>3</sup> /h]	MAX FLOW RATE* [m <sup>3</sup> /h]	BACK-WASH FLOW RATE [m <sup>3</sup> /h]
EA1000005	JUPITER CAB 05 AVL - MINICAB	LOGIX 255/760	3/4"	4,5	25	0,75	0,4	0,6	0,4
EA1000006	JUPITER CAB 10 AVL	LOGIX 255/760	3/4"	10	60	1,5	1,1	1,5	0,4
EA1000007	JUPITER CAB 15 AVL	LOGIX 255/760	3/4"	15	90	2,25	0,9	1,1	0,3
EA1000008	JUPITER CAB 30 AVL	LOGIX 255/760	3/4"	30	180	4,5	1,8	2,3	0,6

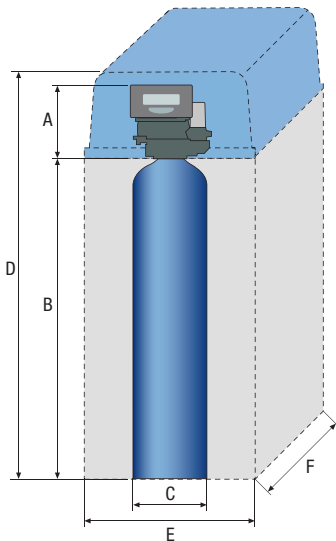

### DIMENSIONS

MODEL	A [mm]	B [mm]	C [mm]	D [mm]	E [mm]	F [mm]	WEIGHT [kg]
JUPITER CAB 05 ATL - MINICAB	190	340	189	540	240	430	7
JUPITER CAB 10 ATL	190	432	214	650	330	500	18
JUPITER CAB 15 ATL	190	898	189	1130	330	500	26
JUPITER CAB 30 ATL	190	897	264	1130	330	500	40
JUPITER CAB 05 AVL - MINICAB	190	340	189	540	240	430	7
JUPITER CAB 10 AVL	190	432	214	650	330	500	18
JUPITER CAB 15 AVL	190	898	189	1130	330	500	26
JUPITER CAB 30 AVL	190	897	264	1130	330	500	40



# JUPITER ATL

- Version where the resin tank is separated from the brine tank, suitable for both domestic and industrial use.

\* The flow and cycle capacity data are calculated using 30°F (300 ppm CaCO<sub>3</sub>) supply water, with a TDS of 500 ppm and a temperature of 20°C.

- **TIME (ATL):** regeneration valve with electronic timer automatically starting the regeneration at a time programmed by the user (for domestic use normally at night, when the demand for softened water is minimal). The unit allows programming of the time and frequency of the regeneration, from a minimum of 1 regeneration every 12 hours to a maximum of 1 every 99 days. Alternatively, the regeneration can be programmed for a fixed day in the week, always at the same time.



## JUPITER ATL

### WITH TIMER CONTROL VALVE

CODE	MODEL	AUTOTROL VALVE	IN/OUT	RESIN [l]	CYCLE CAPACITY* [m <sup>3</sup> x °f]	BRINE CONSUMPTION [kg]	FLOW RATE* [m <sup>3</sup> /h]	MAX FLOW RATE* [m <sup>3</sup> /h]	BACK-WASH FLOW RATE [m <sup>3</sup> /h]
EA1000009	JUPITER 10 ATL	LOGIX 255/740	3/4"	10	60	1,5	1,1	1,5	0,4
EA1000010	JUPITER 15 ATL	LOGIX 255/740	3/4"	15	90	2,25	0,9	1,1	0,3
EA1000011	JUPITER 30 ATL	LOGIX 255/740	3/4"	30	180	4,5	1,8	2,3	0,6
EA1000012	JUPITER 50 ATL	LOGIX 255/740	1"	50	300	7,5	2,1	2,5	0,6
EA1000013	JUPITER 70 ATL	LOGIX 255/740	1"	70	420	10,5	3	3,9	0,9
EA1000014	JUPITER 100 ATL	LOGIX 268/740	1"	100	600	15	3,5	4,5	1,1
EA1000015	JUPITER 120 ATL	LOGIX 268/740	1"	120	720	18	4,5	5,8	1,6

### DIMENSIONS

MODEL	A [mm]	B [mm]	A + B [mm]	C [mm]	D [mm]	E [mm]	F [mm]	WEIGHT [kg]
JUPITER 10 ATL	190	432	622	214	790	380	380	18
JUPITER 15 ATL	190	898	1088	189	790	380	380	26
JUPITER 30 ATL	190	897	1087	264	790	380	380	40
JUPITER 50 ATL	190	1386	1576	264	825	565	565	63
JUPITER 70 ATL	190	1398	1588	338	825	565	565	82
JUPITER 100 ATL	180	1674	1854	365	1105	565	565	112
JUPITER 120 ATL	180	1671	1851	416	1105	565	565	120

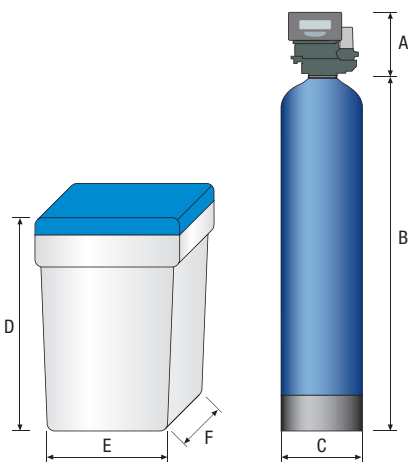





# JUPITER AVL

- Version where the resin tank is separated from the brine tank, suitable for both domestic and industrial use.

\* The flow and cycle capacity data are calculated using 30°F (300 ppm CaCO<sub>3</sub>) supply water, with a TDS of 500 ppm and a temperature of 20°C.

- **VOLUME (AVL):** regeneration valve fitted with a flow sensor and a turbine meter checking the volume of the water treated. This version starts the regeneration at the selected time of the day chosen by the electronics according to the real water consumption, the exchange capacity and the set hardness. The unit allows programming in the following modes:

- time-volume: after reaching the set volume, at a set time.
- pure volume: immediately after reaching the set volume.



## JUPITER AVL - AVM

WITH VOLUMETRIC CONTROL VALVE										
CODE	MODEL	AUTOTROL VALVE	IN/OUT	RESIN [l]	CYCLE CAPACITY* [m <sup>3</sup> x °f]	BRINE CONSUMPTION [kg]	FLOW RATE* [m <sup>3</sup> /h]	MAX FLOW RATE* [m <sup>3</sup> /h]	BACK-WASH FLOW RATE [m <sup>3</sup> /h]	
EA1000026	JUPITER 10 AVL	LOGIX 255/760	3/4"	10	60	1,5	1,1	1,5	0,4	
EA1000027	JUPITER 15 AVL	LOGIX 255/760	3/4"	15	90	2,25	0,9	1,1	0,3	
EA1000028	JUPITER 30 AVL	LOGIX 255/760	3/4"	30	180	4,5	1,8	2,3	0,6	
EA1000029	JUPITER 50 AVL	LOGIX 255/760	1"	50	300	7,5	2,1	2,5	0,6	
EA1000030	JUPITER 70 AVL	LOGIX 255/760	1"	70	420	10,5	3	3,9	0,9	
EA1000031	JUPITER 100 AVL	LOGIX 268/760	1"	100	600	15	3,5	4,5	1,1	
EA1000032	JUPITER 120 AVL	LOGIX 268/760	1"	120	720	18	4,5	5,8	1,6	

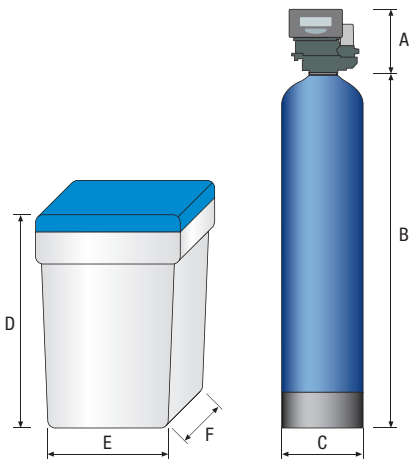

### DIMENSIONS

MODEL	A [mm]	B [mm]	A + B [mm]	C [mm]	D [mm]	E [mm]	F [mm]	WEIGHT [kg]
JUPITER 10 AVL	190	432	622	214	790	380	380	18
JUPITER 15 AVL	190	898	1088	189	790	380	380	26
JUPITER 30 AVL	190	897	1087	264	790	380	380	40
JUPITER 50 AVL	190	1386	1576	264	825	565	565	63
JUPITER 70 AVL	190	1398	1588	338	825	565	565	82
JUPITER 100 AVL	180	1674	1854	365	1105	565	565	112
JUPITER 120 AVL	180	1671	1851	416	1105	565	565	120



# ADRIATIC 5

## PORTABLE SOFTENER

**Portable water softener with regeneration set and pre-filter removal of the total hardness, impurities, chlorine and chloride compounds.**

ADRIATIC 5 is a portable equipment which integrates a softener with a manual control valve that easily operate softening, rinse and regeneration stages, HS-EasyBRINE a disposable brine cartridge for the easiest resin regeneration, CB-EC a carbon block pre-filter, so that the appliance can perform:

- filtration at 10 micron, for crystal clear water;
- dechlorination, get rid of bad tastes and odours, pesticides, insecticides, Volatile Organic Compounds (VOC);
- softening, for a complete or partial removal of the Total Hardness and prevent from scales and calcareous encrustations.

ADRIATIC 5 is applicable for:

- washing and cleaning of every surface with extraordinary NO-SPOT effects with no calcareous residual to be removed after washing, no need for dry and cleanse;
- protection from impurities, chlorine corrosion and calcareous incrustations of pipes, boilers, showers, faucets;
- drinking water improvement when in combination with Atlas Filtri® POU range of filter units (In-Line, Bravo DP, Oasis DP, Depural).

Remark - Adriatic 5 is not a potable water maker: for potable applications use only with safe drinking water.

### VOLUME OF THE WATER SOFTENED

Total hardness conversions:

1°f = 10 ppm CaCO<sub>3</sub> - 1°f = 0,56°T german

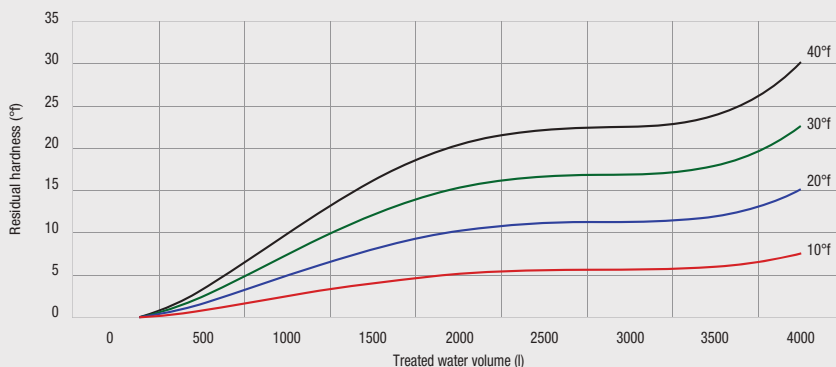

The volume of the water softened with ADRIATIC 5 depends on the total hardness of the inlet water (the raw water entering the softener). The diagram shows the volumes of treated water at different hardness of the inlet water at 10°f, 20°f, 30°f, 40°f up to 4000 liters after the treatment.

The curves show the residual hardness at various inlet hardness: on that basis it is possible to operate the regeneration procedure at the preferred residual hardness level. It is recommended to keep the residual hardness below 10°f.

### CERTIFICATIONS



The products are tested and certified under the most stringent procedures worldwide, **in compliance with DM 25 (Italy), with the sanitary certification ACS (France) and EAC/Ghostreghistrizia (Russia).**

## ACCESSORIES INCLUDED



-X- spanner



-Easy Test TH- Total Hardness test strips blister

### SYMBOLS LEGEND



No Power  
Save Energy



For domestic use



For technical and industrial use



Filter housings made in PET, a highly recyclable plastic, are manufactured with a proprietary procedure saving up to 60% of energy in injection molding compared with standard plastics. That is one of Atlas Filtri commitments to comply with Kyoto Treaty for the reduction of green house gas (CO<sub>2</sub>) emissions in the atmosphere.

CB-EC is the only environmentally friendly carbon block element, made with a proprietary technology reducing green house gas emissions in activated carbon production.



# ADRIATIC 5

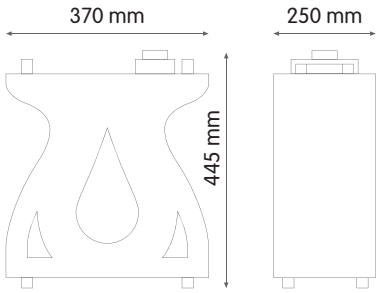

## WORKING CONDITIONS

Max working pressure \_\_\_\_\_ 6 bar (87 psi)  
 Min working pressure \_\_\_\_\_ 2 bar (29 psi)  
 Max working temperature \_\_\_\_\_ 50°C (122°F)  
 Min working temperature \_\_\_\_\_ 4°C (39,2°F)  
 Max Fe \_\_\_\_\_ 0,1 ppm  
 Weight \_\_\_\_\_ 10 kg

## SPECIFICATIONS

Non-toxic materials, suitable for drinking water.  
 Control-valve: NORYL®.  
 Frame: painted aluminium/stainless steel AISI 316 L.  
 Hoses: polyethylene.  
 Resin tank: glass fiber reinforced polyethylene.  
 Brine: polystyrene HS-EasyBRINE cartridge with NaCl.  
 Softening material: strong cationic ion-exchange resin (Na cycle).  
 Filtering and dechlorination medium: activated carbon block cartridge CB-EC, nominal filtration 10 micron.  
 Filter housings: reinforced polypropylene, PET.



## ADRIATIC 5

### PORTABLE SOFTENER

CODE	MODEL	RESIN [L]	IN/OUT	CYCLE CAPACITY [M³ X °F]	BRINE CONSUMPTION [KG]	FLOW RATE [M³/H]	MAX FLOW RATE [M³/H]	BACK-WASH FLOW RATE [M³/H]
RA700010	ADRIATIC 5	4,5	QUICK-FIT (1/2")	25	0,75	0,4	0,6	0,4

## SPARE CARTRIDGES FOR ADRIATIC 5



**CB-EC CTO 10 micron**  
 CODE RE5395109

- CARBON BLOCK. Filtration of fine particles (rust, lime, sand, scales); reduction of chlorine (bad tastes, odours) and chloride pollutants (pesticides, solvents, etc). The average life-time of the filtration CB-EC cartridge is 3-6 months: the life-time depend on the in-let water quality and on the volume of the treated water.



**HS-EasyBRINE**  
 CODE RA5195120

- Container with NaCl specifically formulated for the regeneration of strong cationic resin. To be changed with a new cartridge after every regeneration process. When all the salt of the HS-EasyBRINE cartridge is consumed the resin regeneration process is completed. End cap with antimicrobial flat seal.

# MEDIA FILTERS

MARS IRON REMOVERS - VENUS CHLORINE REMOVERS - SAND QUARTZITE FILTERS - VEGA ARSENIC REMOVERS

ACCESSORIES ON DEMAND

## MARS - VENUS - SAND

The water used for drinking, sanitary or technological applications supplied by the water system or an autonomous source can have various problems such as:

- impurities (sand, clay, silt)
  - iron and manganese
  - excess of chlorine or bad smells and tastes
- In the first case, in order to protect the water system (valves, pressure switches, taps, boilers, etc.) it is necessary to place a filter at the system supply inlet to stop all impurities. If the water contains only sand or small quantities of foreign bodies, normal filter cartridges are used; if clay, silt and/or colloidal substances are present in the water, multi-layer, different size quartz sand filters are used, capable of stopping big quantities of impurities. The **SAND** clarification filters by ATLAS FILTRI consist of a column containing a permanent multi-layer filtering bed; to get rid of the impurities and restore the filter efficiency, just carry out counter-current rinsing at regular intervals. This is done automatically by the controlling head, controlled by an electronic displacement timer/control.
- In the second case iron and manganese must be eliminated because their presence gives water a yellow-reddish colour and an unpleasant taste, causes deposits leading to blockages and often system corrosion. In domestic use the iron in the water can also stain bathroom fittings, taps and linen, with aesthetic and hygienic problems. Drinking water must not contain more than 0.2mg/l of iron or 0.05 mg/l of manganese. **MARS** deferrizing filters by ATLAS FILTRI consist of a column containing a manganese dioxide (pyrolusite) filtering bed acting as a catalyst for the oxidation of the iron, manganese and hydrogen sulphide present in the water. To ensure the filter is effective, carry out counter-current rinsing of the filtering bed at regular intervals. In this case too this is done automatically by the controlling head, controlled by an electronic displacement timer/control.
- In the third case, a filter must be installed at the water supply inlet using charcoal filters. The **VENUS** dechlorination filters by ATLAS FILTRI consist of a column containing a filtering bed of selected vegetable granular charcoal, with a high internal surface and optimum porous structure to absorb the organic compounds present in the water for civil or industrial use. To ensure the filter is effective, carry out counter-current rinsing of the filtering bed at regular intervals. As with the other models, this is done automatically by the head, controlled by an electronic displacement timer/control. In drinking water systems a disinfection (UV or chlorine dosing) system must be installed downstream from the dechlorination filter.

## VEGA

The average content of arsenic found in the rocks of the earth's crust is about 1.5 ppm, which corresponds to 1.5g of arsenic per ton of rock. In the food chain and water for human consumption, arsenic is extracted from rocks, soil and water.

Small doses of arsenic are considered a vital element for man, but higher doses have very serious effects.

The European Community has recognized the problems connected with this element and has consequently reduced the limit value for water for human consumption to 10 µg/l.

Arsenic can be divided into As5+ (forming compounds called arsenates) and As3+ (forming compounds called arsenites).

All treatment processes for extracting arsenic from water for human consumption usually extract As5+ better than As3+.

Consequently the oxidizing of As3+ (in comparison with As5+) with substances such as hypochlorite, potassium permanganate and ozone is often required.

At the moment the separation of arsenic from drinking water with granulated ferric hydroxide (GFH) is a very advantageous process thanks to low investment and maintenance costs.

In removing arsenic from water, both As3+ and As5+ compounds are absorbed by the GFH in a specially constructed filter the water to be treated runs through. Even during very long running periods, the filtering material maintains good porosity and good capacity of holding arsenic.

Good porosity is due to the fact that the grain size is very homogeneous between 0.2 and 2 mm. The high capacity of absorbing arsenic is due to the fact that GFH is produced so that it has low crystallinity and high microporosity.

The **VEGA** arsenic removing filters by ATLAS FILTRI can be used to treat all or just part of the water for human consumption.

The problem of whether to treat all or just part of the water for human consumption with subsequent mixing depends on the maximum level of arsenic required, but above all from the expected peak consumption.

The typical behaviour of a GFH arsenic removal system shows that the content of arsenic in the water treated with the above filters slowly and predictably increases with time. This means there is no sudden 'death' of the absorbing power typical of other filtering substances.



chlorine test drops CODE RE8000012

iron test drops CODERE8000010

arsenic test drops CODE RE8000013



manual by-pass for 263/268 valve CODE EA1015037

manual by-pass for 255 valve CODE EA1015038

## OPERATING MODES

- **TIME (ATL):** regeneration valve with electronic timer automatically starting the regeneration at a time programmed by the user (for domestic use normally at night, when the demand for softened water is minimal). The unit allows programming of the time and frequency of the regeneration, from a minimum of 1 regeneration every 12 hours to a maximum of 1 every 99 days. Alternatively, the regeneration can be programmed for a fixed day in the week, always at the same time.
- **VOLUME (AVL):** regeneration valve fitted with a flow sensor and a turbine meter checking the volume of the water treated. This version starts the regeneration at the selected time of the day chosen by the electronics according to the real water consumption, the exchange capacity and the set hardness. The unit allows programming in the following modes:
  - time-volume: after reaching the set volume, at a set time.
  - pure volume: immediately after reaching the set volume.

## CERTIFICATIONS



The products are tested and certified under the most stringent procedures worldwide, in compliance with DM 25 (Italy) and with the sanitary certification EAC (Russia).

## SYMBOLS LEGEND



For domestic use



For technical and industrial use

## INSTALLATION SCHEME

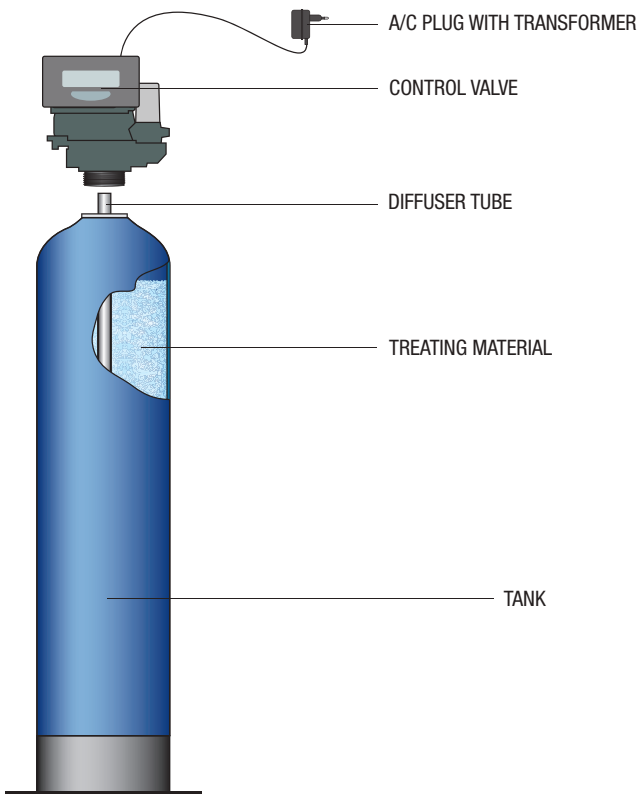

## MATERIALS

Non-toxic materials, suitable for drinking water.

- Control-valve: NORYL®
- Tank: glass-fibre reinforced polyethylene
- Treating material:

**SAND** - sand and single-crystal spherical quartz gravel of alluvial origin with high silica content, specifically selected to filter water for civil and industrial use.

**MARS PRL** - superb quality and purity pyrolusite (manganese dioxide), obtained by washing, drying and screening mineral selected specifically for oxidizing.

**VENUS** - selected vegetable granular charcoal, with a high internal surface and optimum porous structure to absorb the organic compounds present in the water for civil or industrial use.

**VEGA** - GFH granular ferric hydroxide: absorbing means for the selective removal of arsenic (both arsenite and arsenate), phosphate, selenium and other heavy metals from natural water.

## TECHNICAL REQUIREMENTS

Microprocessor dedicated electronics with the following characteristics:

- easily programmed display with dedicated keyboard
- possible manual start of the regeneration process with guided progression through the various phases
- display of the regeneration phases and their duration
- memory autonomy up to 10 days (if the power supply is lacking)
- unit safety voltage 12V/50Hz

## WORKING CONDITIONS

Max working pressure .....	6 bar
Min working pressure .....	2 bar
Max working temperature .....	50°C
Electrical functioning .....	12V
Electrical absorption .....	8W

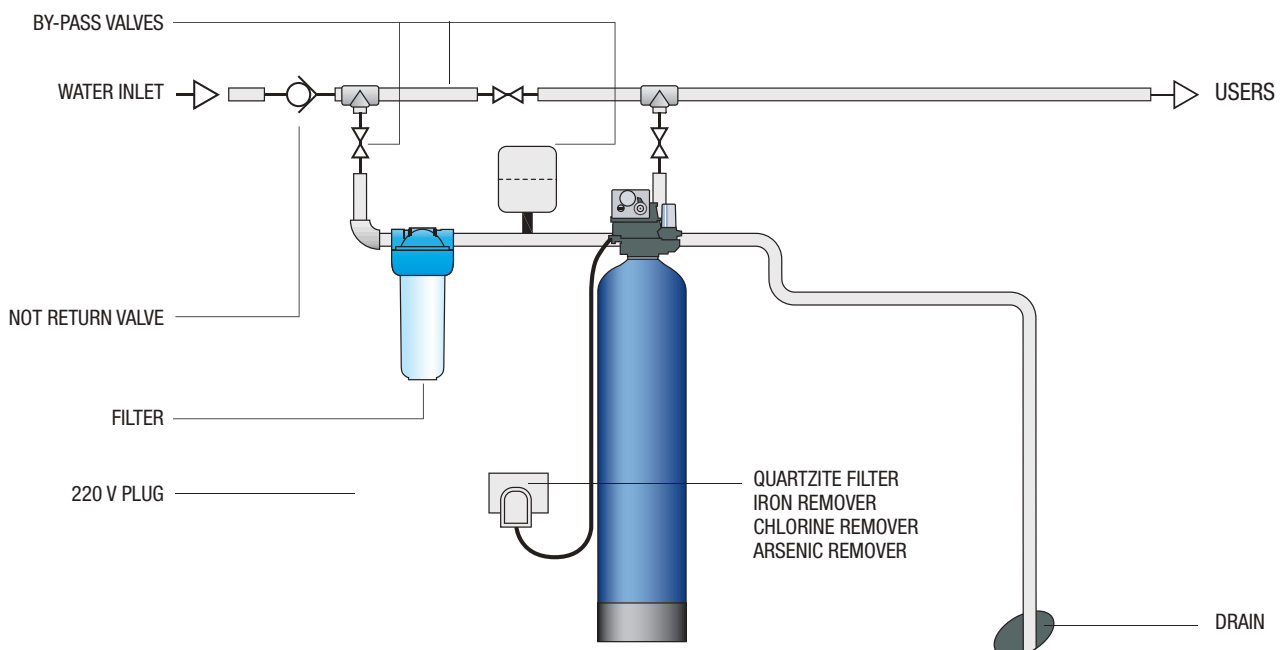





# MARS iron removers

Standard models with PYROLUSITE treatment material.  
Note: models with different treatment materials  
(BIRM, MANGANESE GREENSAND) available on request

\* Data referring to water with 3 ppm iron maximum

\*\* Data referring to water with 1.5 ppm iron max and a tank  
oxidizing time of 30 minutes.

The flow data are calculated using supply water with a TDS of  
500 ppm and at a temperature of 20°C.

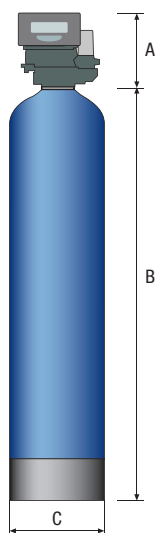

## MARS PRL ATL

WITH TIMER CONTROL VALVE												
CODE	MODEL	AUTOTROL VALVE	IN/OUT	MEDIA VOLUME [l]	FLOW RATE* [m³/h]	MAX FLOW RATE** [m³/h]	BACK WASH FLOW RATE [m³/h]	A [mm]	B [mm]	A + B [mm]	C [mm]	WEIGHT [kg]
EA1000075	MARS PRL 25 ATL	LOGIX 263/740	1"	25	0,3	0,5	0,8	180	1132	1312	214	55
EA1000076	MARS PRL 50 ATL	LOGIX 263/740	1"	50	0,5	0,8	1,3	180	1386	1566	264	100
EA1000077	MARS PRL 75 ATL	LOGIX 263/740	1"	75	0,8	1,3	2,1	180	1398	1578	338	150
EA1000078	MARS PRL 100 ATL	LOGIX 263/740	1"	100	0,9	1,5	2,3	180	1674	1854	365	195
EA1000079	MARS PRL 125 ATL	LOGIX 263/740	1"	125	1,2	1,9	2,7	180	1671	1851	416	250
EA1000080	MARS PRL 150 ATL	LOGIX 263/740	1"	150	1,5	2,5	4,6	180	1722	1902	491	300

## MARS PRL AVL

WITH VOLUMETRIC CONTROL VALVE												
CODE	MODEL	AUTOTROL VALVE	IN/OUT	MEDIA VOLUME [l]	FLOW RATE* [m³/h]	MAX FLOW RATE** [m³/h]	BACK WASH FLOW RATE [m³/h]	A [mm]	B [mm]	A + B [mm]	C [mm]	WEIGHT [kg]
EA1000086	MARS PRL 25 AVL	LOGIX 263/760	1"	25	0,3	0,5	0,8	180	1132	1312	214	55
EA1000087	MARS PRL 50 AVL	LOGIX 263/760	1"	50	0,5	0,8	1,3	180	1386	1566	264	100
EA1000088	MARS PRL 75 AVL	LOGIX 263/760	1"	75	0,8	1,3	2,1	180	1398	1578	338	150
EA1000089	MARS PRL 100 AVL	LOGIX 263/760	1"	100	0,9	1,5	2,3	180	1674	1854	365	195
EA1000090	MARS PRL 125 AVL	LOGIX 263/760	1"	125	1,2	1,9	2,7	180	1671	1851	416	250
EA1000091	MARS PRL 150 AVL	LOGIX 263/760	1"	150	1,5	2,5	4,6	180	1722	1902	491	300



# VENUS chlorine removers

\* Data referring to water with 1 ppm chlorine max and 1 ppm absorbing substances max.

\*\* Data referring to water with 1 ppm chlorine max in primary water. The flow data are calculated using supply water with a TDS of 500 ppm and at a temperature of 20°C.

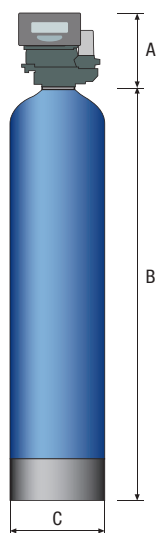

## VENUS ATL

WITH TIMER CONTROL VALVE												
CODE	MODEL	AUTOTROL VALVE	IN/OUT	MEDIA VOLUME [l]	FLOW RATE* [m³/h]	MAX FLOW RATE** [m³/h]	BACK WASH FLOW RATE [m³/h]	A [mm]	B [mm]	A + B [mm]	C [mm]	WEIGHT [kg]
EA1000097	VENUS 25 ATL	LOGIX 263/740	1"	25	0,5	0,8	0,7	180	1132	1312	214	20
EA1000098	VENUS 50 ATL	LOGIX 263/740	1"	50	0,8	1,3	1,1	180	1386	1566	264	34
EA1000099	VENUS 75 ATL	LOGIX 263/740	1"	75	1,3	2,1	1,8	180	1398	1578	338	47
EA1000100	VENUS 100 ATL	LOGIX 263/740	1"	100	1,5	2,5	2,3	180	1674	1854	365	69
EA1000101	VENUS 125 ATL	LOGIX 263/740	1"	125	1,9	3,2	2,7	180	1671	1851	416	80
EA1000102	VENUS 150 ATL	LOGIX 263/740	1"	150	2,5	4,1	3,4	180	1722	1902	491	100
EA1000103	VENUS 200 ATL	LOGIX 263/740	1"	200	3,4	5,6	4,6	180	2064	2244	555	130

## VENUS AVL

WITH VOLUMETRIC CONTROL VALVE												
CODE	MODEL	AUTOTROL VALVE	IN/OUT	MEDIA VOLUME [l]	FLOW RATE* [m³/h]	MAX FLOW RATE** [m³/h]	BACK WASH FLOW RATE [m³/h]	A [mm]	B [mm]	A + B [mm]	C [mm]	WEIGHT [kg]
EA1000108	VENUS 25 AVL	LOGIX 263/760	1"	25	0,5	0,8	0,7	180	1132	1312	214	20
EA1000109	VENUS 50 AVL	LOGIX 263/760	1"	50	0,8	1,3	1,1	180	1386	1566	264	34
EA1000110	VENUS 75 AVL	LOGIX 263/760	1"	75	1,3	2,1	1,8	180	1398	1578	338	47
EA1000111	VENUS 100 AVL	LOGIX 263/760	1"	100	1,5	2,5	2,3	180	1674	1854	365	69
EA1000112	VENUS 125 AVL	LOGIX 263/760	1"	125	1,9	3,2	2,7	180	1671	1851	416	80
EA1000113	VENUS 150 AVL	LOGIX 263/760	1"	150	2,5	4,1	3,4	180	1722	1902	491	100
EA1000114	VENUS 200 AVL	LOGIX 263/760	1"	200	3,4	5,6	4,6	180	2064	2244	555	130



# SAND quartzite filters

\* Data referring to water with turbidity lower than 10 mg/l of SiO<sub>2</sub> or 4 Jackson units.

The flow data are calculated using supply water with a TDS of 500 ppm and at a temperature of 20°C.

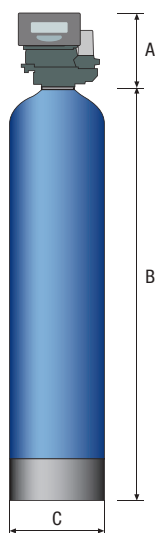

## SAND ATL

### WITH TIMER CONTROL VALVE

CODE	MODEL	AUTOTROL VALVE	IN/OUT	MEDIA VOLUME [l]	FLOW RATE* [m <sup>3</sup> /h]	MAX FLOW RATE** [m <sup>3</sup> /h]	BACK WASH FLOW RATE [m <sup>3</sup> /h]	A [mm]	B [mm]	A + B [mm]	C [mm]	WEIGHT [kg]
EA1000057	SAND 25 ATL	LOGIX 263/740	1"	25	0,6	1	1	180	1132	1312	214	50
EA1000058	SAND 50 ATL	LOGIX 263/740	1"	50	1	1,5	1,5	180	1386	1566	264	87
EA1000059	SAND 75 ATL	LOGIX 263/740	1"	75	1,7	2,6	2,6	180	1398	1578	338	130
EA1000060	SAND 100 ATL	LOGIX 263/740	1"	100	2	3	3	180	1674	1854	365	170
EA1000061	SAND 125 ATL	LOGIX 263/740	1"	125	2,6	3,9	3,9	180	1671	1851	416	230
EA1000062	SAND 150 ATL	LOGIX 263/740	1"	150	3,3	4,9	4,9	180	1722	1902	491	280

## SAND AVL

### WITH VOLUMETRIC CONTROL VALVE

CODE	MODEL	AUTOTROL VALVE	IN/OUT	MEDIA VOLUME [l]	FLOW RATE* [m <sup>3</sup> /h]	MAX FLOW RATE** [m <sup>3</sup> /h]	BACK WASH FLOW RATE [m <sup>3</sup> /h]	A [mm]	B [mm]	A + B [mm]	C [mm]	WEIGHT [kg]
EA1000066	SAND 25 AVL	LOGIX 263/760	1"	25	0,6	1	1	180	1132	1312	214	50
EA1000067	SAND 50 AVL	LOGIX 263/760	1"	50	1	1,5	1,5	180	1386	1566	264	87
EA1000068	SAND 75 AVL	LOGIX 263/760	1"	75	1,7	2,6	2,6	180	1398	1578	338	130
EA1000069	SAND 100 AVL	LOGIX 263/760	1"	100	2	3	3	180	1674	1854	365	170
EA1000070	SAND 125 AVL	LOGIX 263/760	1"	125	2,6	3,9	3,9	180	1671	1851	416	230
EA1000071	SAND 150 AVL	LOGIX 263/760	1"	150	3,3	4,9	4,9	180	1722	1902	491	280



# VEGA arsenic remover

\* Data referring to water with 40 micrograms arsenic maximum (contact time 4 minutes)

\*\* Data referring to water with 30 micrograms arsenic maximum (contact time 3 minutes)

The flow data are calculated using supply water with a TDS of 500 ppm and at a temperature of 20°C.

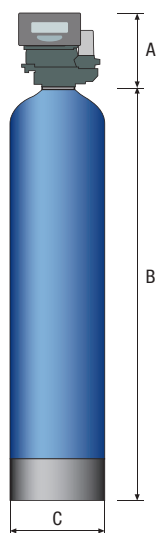

## VEGA ATL

WITH TIMER CONTROL VALVE												
CODE	MODEL	AUTOTROL VALVE	IN/OUT	MEDIA VOLUME [l]	FLOW RATE* [m³/h]	MAX FLOW RATE** [m³/h]	BACK WASH FLOW RATE [m³/h]	A [mm]	B [mm]	A + B [mm]	C [mm]	WEIGHT [kg]
EA1000119	VEGA 40 ATL	LOGIX 263/740	1"	40	0,4	0,5	0,5	180	1386	1566	257	65
EA1000120	VEGA 55 ATL	LOGIX 263/740	1"	55	0,6	0,8	0,7	180	1338	1518	310	85
EA1000121	VEGA 70 ATL	LOGIX 263/740	1"	70	0,8	1,1	0,8	180	1393	1573	336	100
EA1000122	VEGA 110 ATL	LOGIX 263/740	1"	110	1,2	1,6	1,2	180	1671	1851	413	165
EA1000123	VEGA 155 ATL	LOGIX 263/740	1"	155	1,6	2,1	1,5	180	1722	1902	486	220
EA1000124	VEGA 170 ATL	LOGIX 263/740	1"	170	1,8	2,4	2	180	1434	1614	550	235

## VEGA AVL

WITH VOLUMETRIC CONTROL VALVE												
CODE	MODEL	AUTOTROL VALVE	IN/OUT	MEDIA VOLUME [l]	FLOW RATE* [m³/h]	MAX FLOW RATE** [m³/h]	BACK WASH FLOW RATE [m³/h]	A [mm]	B [mm]	A + B [mm]	C [mm]	WEIGHT [kg]
EA1000130	VEGA 40 AVL	LOGIX 263/760	1"	40	0,4	0,5	0,5	180	1386	1566	257	65
EA1000131	VEGA 55 AVL	LOGIX 263/760	1"	55	0,6	0,8	0,7	180	1338	1518	310	85
EA1000132	VEGA 70 AVL	LOGIX 263/760	1"	70	0,8	1,1	0,8	180	1393	1573	336	100
EA1000133	VEGA 110 AVL	LOGIX 263/760	1"	110	1,2	1,6	1,2	180	1671	1851	413	165
EA1000134	VEGA 155 AVL	LOGIX 263/760	1"	155	1,6	2,1	1,5	180	1722	1902	486	220
EA1000135	VEGA 170 AVL	LOGIX 263/760	1"	170	1,8	2,4	2	180	1434	1614	550	235



# PRODUCTS FOR WATER TREATMENT

A full range of products and media for water treatment as: anti-scale conditioning, removal of hardness, iron, chlorine, arsenic, nitrates and demineralization.

Water treatment media are selected amongst the most advanced materials to provide the highest performances and are available in a range of packing suitable to combine with every Atlas Filtri product and equipment.

## PRODUCTS FOR WATER TREATMENTS

### POLYPHOSPHATE LARGE CRYSTALS

CODE	ITEM	PACKING MODE	NET KG	APPLICABLE TO
RE8010001	POLYPHOSPHATE CRYSTALS 10/20	DRUM	25	ALL HOUSINGS, DOSAPROP, DOSAFOS
RE8010003	POLYPHOSPHATE CRYSTALS 10/20	PACK	1,5	ALL HOUSINGS, DOSAPROP, DOSAFOS
RE8010005	POLYPHOSPHATE CRYSTALS 10/20	PACK	0,5	ALL HOUSINGS, DOSAPROP, DOSAFOS

### POLYPHOSPHATE SMALL CRYSTALS

CODE	ITEM	PACKING MODE	NET KG	APPLICABLE TO
RE8010002	POLYPHOSPHATE CRYSTALS 6/10	DRUM	25	ALL HOUSINGS, DOSAPROP, DOSAFOS
RE8010004	POLYPHOSPHATE CRYSTALS 6/10	PACK	1,5	ALL HOUSINGS, DOSAPROP, DOSAFOS
RE8010006	POLYPHOSPHATE CRYSTALS 6/10	PACK	0,5	ALL HOUSINGS, DOSAPROP, DOSAFOS
RE8010009	POLYPHOSPHATE CRYSTALS 6/10	BLISTER	0,16	DOSAL

### POLYPHOS ready-to-use polyphosphate powder based refills

CODE	ITEM	PACKING MODE	APPLICABLE TO
RE5000055	POLIPHOS A	2 REFILLS SKINPACK	DOSAPLUS 2, 3, 4
RE5000057	POLIPHOS A	12 REFILLS BOX	DOSAPLUS 2, 3, 4
RE5000054	POLIPHOS B	1 REFILL BAG	DOSAPLUS 5, 6, 7

### POLYPHOSPHATE POWDER

CODE	ITEM	PACKING MODE	NET KG	APPLICABLE TO
RE8020001	POLIPHOSPHATE POWDER	DRUM	18	DOSAPLUS 2, 3, 4, 5, 6, 7
RE8020002	POLIPHOSPHATE POWDER	PACK	1	DOSAPLUS 2, 3, 4, 5, 6, 7
RE8020004	POLIPHOSPHATE POWDER	PACK	0,5	DOSAPLUS 2, 3, 4, 5, 6, 7

### GRANULAR ACTIVATED CARBON (G.A.C.) - coconut shell

CODE	ITEM	PACKING MODE	NET KG	APPLICABLE TO
RE8030003	GRANULAR CARBON 48 - 25 KG	BAG	25	VENUS, LA CARTRIDGES
RE8030002	GRANULAR CARBON 48 - 0,3 KG	PACK	0,3	LA CARTRIDGES
RE8030006	GRANULAR CARBON 2040 - 25 KG	BAG	25	VENUS, LA CARTRIDGES
RE8030005	GRANULAR CARBON 2040 - 0,3 KG	PACK	0,3	LA CARTRIDGES
RE8030007	GRANULAR CARBON SILVER IMP. 0,2%	BAG	25	VENUS, LA CARTRIDGES
RE8030008	GRANULAR CARBON SILVER IMP. 0,2%	PACK	0,3	LA CARTRIDGES

### IONIC-EXCHANGE RESINS

CODE	ITEM	PACKING MODE	NET KG	APPLICABLE TO
RE8040000	STRONG CATIONIC RESIN	BAG	25	JUPITER, ADRIATIC, QA-CF CARTRIDGES
RE8040002	STRONG CATIONIC RESIN	PACK	1	QA-CF CARTRIDGES
RE8060000	STRONG ANIONIC RESIN	BAG	25	QA-AF CARTRIDGES
RE8060002	STRONG ANIONIC RESIN	PACK	1	QA-AF CARTRIDGES
RE8050000	MIXED-BED RESIN	BAG	25	QA-LM CARTRIDGES
RE8050002	MIXED-BED RESIN	PACK	1	QA-LM CARTRIDGES

### OTHER MEDIA

CODE	ITEM	NET KG	APPLICABLE TO
EA1010002	PYROLUSITE	25	MARS (IRON REMOVERS)
EA1010015	GFH - GRANULAR FERRIC HYDROXIDE	30	VEGA (ARSENIC REMOVERS)
EA1010003	QUARTZ SAND 0,8-1,2 MM	25	MARS (IRON REMOVERS), SAND
EA1010004	QUARTZ GRAVEL 1,5-2,5 MM	25	SAND
EA1010005	QUARTZ GRAVEL 4-6 MM	25	SAND, VENUS, MARS, VEGA

## PACKING MODE



DRUM



BAG



PACK



BLISTER



2 REFILLS SKINPACK



12 REFILLS BOX



1 REFILL BAG







# UV STERILIZERS

UV RAYS sterilization equipments

A range of UV lamps fit for every use  
in water sterilization  
with flow rates demand  
from 300 to 2800 l/h  
with IN/OUT threaded connections  
from 1/8" to 1"

# UV STERILIZERS

## STERILIZATION EQUIPMENTS

The small part of electro-magnetic spectrum having wave lengths included between 100 and 400 nm (thousandths of micron) is defined as the space of the ultra-violet irradiation. The UV-C are part of the subspace characterized by the wave lengths included between 100 and 280 nm. Electro-magnetic waves with different wave length and width induce interactions with the matter of different nature; the UV-C irradiation with  $\lambda = 254\text{nm}$  is particularly interesting thanks to its marked germicidal power.

The high germicidal power of this wave length must be sought in DNA and in the link of its fundamental components (nucleotids). DNA is a macromolecule present in all living organisms in which all information necessary for life and reproduction reside. The alteration, induced by the UV-C irradiation, of some chemical links present among nucleotids is able to change the information contained and conveyed by DNA, these alterations prevent its normal activity and this irreversibly leads to the cellular death.

For being effective in the disinfection, an electro-magnetic wave, besides being of a certain kind ( $\lambda = 254\text{nm}$ ) it must possess also a minimum value of intensity to be able to ensure a minimum dose to water. A UV sterilizer, if correctly sized, is able to give water a dose sufficient for reducing almost all the commonest micro-organisms present in water. Normally a UV disinfection system must have a UV dose higher than  $300\text{ J/m}^2$ .

UV-C rays are produced with the help of special fluorescent lamps containing mercury fumes, these lamps are made of a very pure quartz (>99.99%  $\text{SiO}_2$ ) transparent to the UV-C light which they emit in an almost monochromatic form (>95% of  $\lambda = 254\text{nm}$ ).

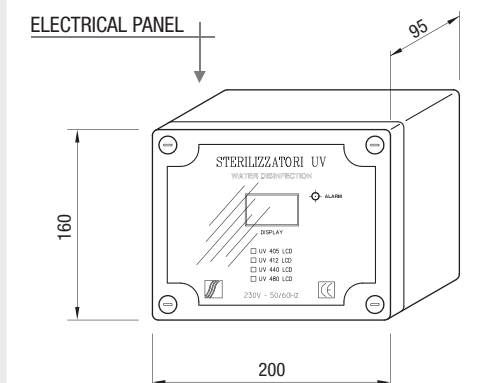
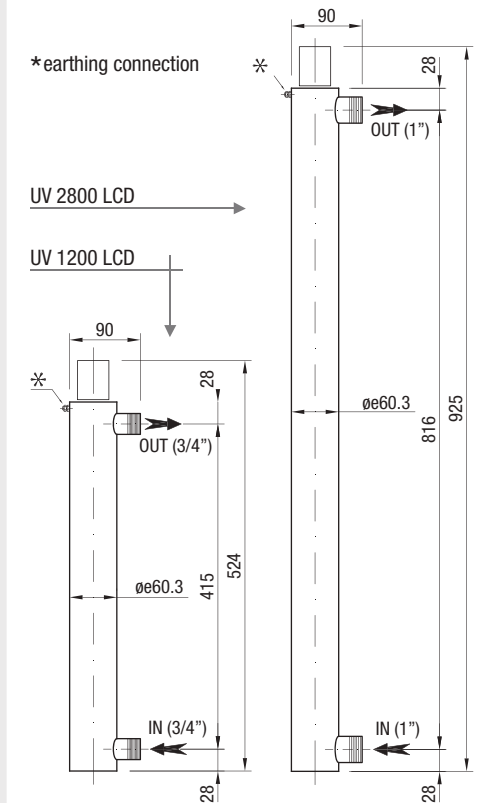
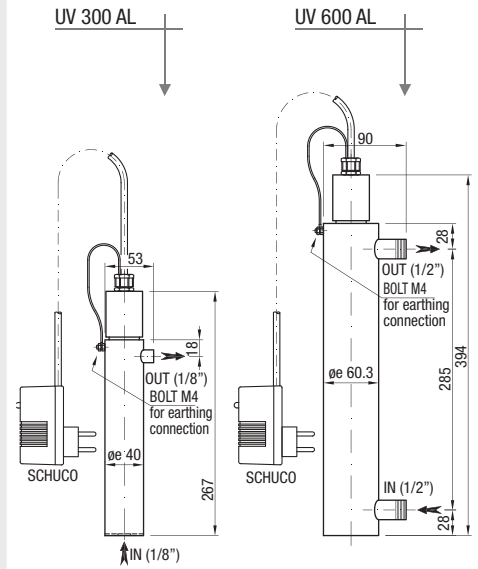
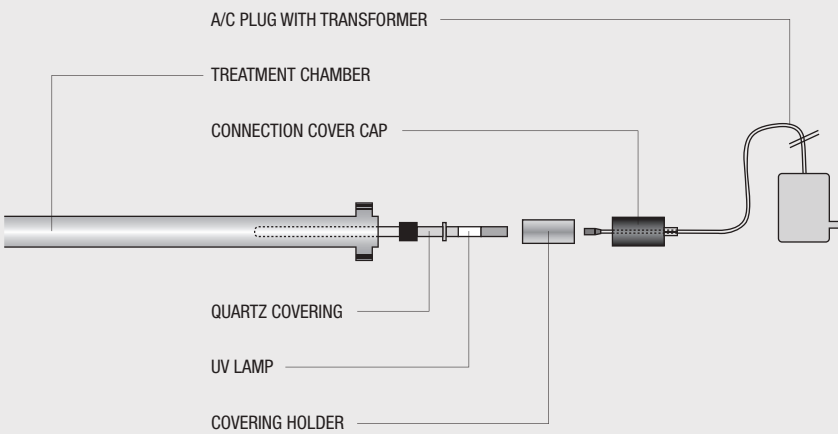



# UV 300 - UV 600



## UV 300 AL

### STERILIZERS WITH BALLAST

CODE	MAX FLOW RATE	NUMBER OF LAMPS	LAMP LIFE-SPAN	UV-C DOSE	ELECTRICAL ABSORPTION
EA3500001	300 l/h	1 x 12 W	9000 HOURS	≥ 300 J/m <sup>2</sup>	12 Wh

#### UV CHAMBER

Material: AISI 304 - optional AISI 316L  
 IN / OUT: 1/8" F  
 Working pressure: 9 bar

#### TRANSFORMER

Electrical supply: 230V - 50/60 Hz  
 Red led of anomaly: YES  
 Connecting wire: 90 cm



## UV 600 AL

### STERILIZERS WITH BALLAST

CODE	MAX FLOW RATE	NUMBER OF LAMPS	LAMP LIFE-SPAN	UV-C DOSE	ELECTRICAL ABSORPTION
EA3500002	600 l/h	1 x 16 W	9000 HOURS	≥ 300 J/m <sup>2</sup>	16 Wh

#### UV CHAMBER

Material: AISI 304 - optional AISI 316L  
 IN / OUT: 1/2" M  
 Working pressure: 9 bar

#### TRANSFORMER

Electrical supply: 230V - 50/60 Hz  
 Red led of anomaly: SI  
 Connecting wire: 90 cm

Dose valid with transmittance 99% at 1 cm - T 20°C - after 9000 hours

# UV 1200 - UV 2800

## UV 1200 LCD

### STERILIZERS WITH CONTROL PANEL

CODE	MAX FLOW RATE	NUMBER OF LAMPS	LAMP LIFE-SPAN	UV-C DOSE	ELECTRICAL ABSORPTION	ELECTRICAL PANEL
EA3500003	1200 l/h	1 x 30 W	9000 HOURS	≥ 300 J/m <sup>2</sup>	30 Wh	LCD / LCD PLUS

#### UV CHAMBER

Material: AISI 304 - optional AISI 316L  
 IN / OUT: 3/4" M  
 Working pressure: 9 bar

## UV 2800 LCD

### STERILIZERS WITH CONTROL PANEL

CODE	MAX FLOW RATE	NUMBER OF LAMPS	LAMP LIFE-SPAN	UV-C DOSE	ELECTRICAL ABSORPTION	ELECTRICAL PANEL
EA3500004	2800 l/h	1 x 40 W	9000 HOURS	≥ 300 J/m <sup>2</sup>	40 Wh	LCD / LCD PLUS

#### UV CHAMBER

Material: AISI 304 - optional AISI 316L  
 IN / OUT: 1" M  
 Working pressure: 9 bar

Dose valid with transmittance 99% at 1 cm - T 20°C - after 9000 hours

# CONTROL PANEL

#### LCD CONTROL PANEL

electrical alimentation 230V - 50/60 Hz  
 protection degree IP55  
 power cable 100 cm  
 cable lamps 100 cm  
 LCD Display with microprocessor control  
 count down hour-meter  
 red led of anomaly  
 alarm relay free contact NO/NC  
 alarm relay 230 V NO/NC outlet - 2 A max

#### LCD PLUS CONTROL PANEL

electrical alimentation 230V - 50/60 Hz  
 protection degree IP55  
 power cable 100 cm  
 cable lamps 100 cm  
 LCD Display with microprocessor control  
 count down hour-meter  
 red led of anomaly  
 alarm relay free contact NO/NC  
 alarm relay 230 V NO/NC outlet - 2 A max  
 display of Irradiation / temperature control  
 shutdown for high temperature UV chamber  
 resettable count down hour-meter with alarm for end lamp life





# RO

## Reverse Osmosis equipments

A range of Reverse Osmosis equipment designed to provide the highest performances with flow rates demand from 50 to 1000 l/h





# RO REVERSE OSMOSIS

## TECHNICAL FEATURES

Direct Osmosis is a phenomenon that happens normally in nature, for instance in the cells of all living organisms, and it is the process where with two solutions of different concentration divided by a semi-permeable membrane (that is allowing water but no salts to go through), the more diluted solution tends to move naturally towards the more concentrated solution till the concentration of the two solutions becomes the same; the pressure created on the membrane because of this flow is called Osmotic Pressure.

**Exploiting this principle, it is possible to reverse the process by applying a similar but adverse pressure to the concentrated solution to obtain from it a solution of lower concentration: this process is called Reverse Osmosis.**

The osmotic membrane carrying out the best filtering level achievable, behaves like a barrier not only against the salts and inorganic substances making up the saline composition of the water, but also against organic substances such as pesticides, pyrogens, viruses and bacteria; a nominal rejection (reduction capacity) of 100% can be reached with bacteria.

The bigger the difference between the pressure applied and the osmotic pressure, the bigger is the quantity of water produced per unit of surface of semi-permeable membrane.

The supply pressure required varies according to the type of water and salinity to be treated (therefore according to the relative osmotic pressure to overcome):

- System water: from 2-3 up to 18-20 bar
- Brackish water: from 7-8 up to 34-40 bar
- Sea water: from 50-55 up to 70-85 bar

The most suitable membrane (as far as type and dimension are concerned) must be chosen for each system, following a modular criterion, so that the chosen membrane is arranged following a system of elements in series and in parallel.

A reverse osmosis membrane cannot remove 100% of salts (even if today 99.5% can be achieved) and cannot treat 100% of the supplied solution, therefore a reverse osmosis system has a Supply, a Product (also called Permeate) and a Discharge (also called Reject or Concentrate).

These days reverse osmosis technology has undergone such quick development that compact, simple, versatile systems are achieved, characterized by constant output, both in terms of water produced and its quality.

No civil or industrial business exists that can do without specifically treated water; from the water for boilers that must have precise chemical-physical specifications to process water (chemical and pharmaceutical, food, drink industries, etc.) that must adhere to stringent production requirements, the possibilities for use of the reverse osmosis process can be considered endless. In this sector too, reverse osmosis technology has conquered a leading role thanks to its adaptability, cost-effectiveness and running simplicity.

The RO reverse osmosis systems by ATLAS FILTRI use very high quality components and are designed to meet the requirements of any customer, on the basis of the analysis results of the origin water; apart from a standard range, on request ATLAS FILTRI can provide specific solutions.

Every installation can be fitted with pre- and post-treatment systems; ATLAS FILTRI can boast a wide experience in the water treatment and filtering sector, with a wide range of items and equipment for both the domestic/civil and industrial sectors.

- **Domestic uses:** cleaning-up of drinking water, elimination of any smells and tastes connected to the presence of chlorine or chlorine derivatives, pesticides, insecticides, fungicides, heavy metals, micro-organisms, strong reduction in salt content.
- **Technical uses:** in all processes where demineralized water is used, production of drinking water from wells or sources with values within their operational conditions.

**NOTES: The system is suitable to treat water with certain chemical-physical and microbiological characteristics that might require pre-treatments, so it's always necessary to have a complete analysis of the water to be treated.**

## CERTIFICATIONS



**EAC**

The products are tested and certified under the most stringent procedures worldwide, **in compliance with DM 25 (Italy) and with the sanitary certification EAC/Ghostreghistrizia (Russia).**

## SYMBOLS LEGEND



For domestic use



For technical and industrial use



# RO050.DGT - RO090.DGT

## PRE-TREATMENT SECTION

Consisting of a 10" DUPLEX filtration group: first stage carbon cartridge, second stage cartridge with 5 micron filtration rate.

## PRESSURIZATION SECTION

Made up of a brass rotary vane electric pump with by-pass.

## PERMEATION SECTION

Consisting of high-productivity and low-consumption reverse osmosis permeator (low energy). The membrane is closed in a polypropylene vessel.

## HOSES

Feeding, permeate, high pressure and discharge hoses in 12 bar pressure resistant material.

## CONTROL AND HYDRAULIC CONTROL SECTION

- Pressure gauge for feed pressure at the membranes
- Flow restrictor for the adjustment of the draining flow
- Protection pressure switch with system lock for low supply water level
- Protection pressure switch with system lock for permeator supply high pressure
- Two pressure switches on permeate line for automatic system stop (permeate working pressure 1,8÷3 bar)
- Membrane solenoid valve for system supply management
- Membrane solenoid valve for the management of the osmosis module flushing
- Conductivity probes for feed water and permeate
- Tank in plastic suitable for food contact

**SUPPORT FRAME** built in AISI 304 stainless steel complete with brackets, vessel and hose fixing collars, valves and connections, leads for the various uses, electric control panel.

## OPTIONAL

- UV Lamp on permeate line.



## RO050.DGT - RO050.ECO

PERMEATE PRODUCTION 50 LITRES/HOUR											
CODE	MODEL	PERMEATE ± 10% (T = 20°C)	FINAL SALT REJECTION	MAXIMUM RECOVERY	TDS	SDI	TURBIDITY	HARDNESS	FREE CHLORINE IN	BACTERIA	DIMENSIONS (MAX SIZE)
EA0500002	RO050.DGT	45 l/h	≥ 95 %	20 (%)	≤ 500 ppm	≤ 3	1 NTU MAX	≤ 25 °f	≤ 0,2 mg/l	ABSENT	600 x 310 x H650 mm
EA0510015	RO090.DGT	90 l/h	≥ 95 %	35 (%)	≤ 500 ppm	≤ 3	1 NTU MAX	≤ 25 °f	≤ 0,2 mg/l	ABSENT	600 x 450 x H650 mm

## CHARACTERISTICS

Min/max feed water pressure.....	1,5 ÷ 4 bar	Total installed power.....	300 W
Min/max feed water temperature.....	5°C ÷ 30°C	Monophase electrical supply.....	230 V / 50-60 Hz
Feed water minimum flow rate.....	400 l/h	Supply connection.....	G 1/2" F
Min/max ambient temperature.....	5 °C ÷ 40 °C	Permeate / Discharge connections.....	Ø 10 / 6 mm
Operating pressure.....	≤ 10 bar		



CONTROL PANEL

## ELECTRO-MECHANICAL CONTROL PANEL

- IP55 electrical box
- Built with microprocessors and fitted with a digital display
- Digital conductivity meter with LCD display to read the conductivity of the feed water and the water produced
- Alarm with visual descriptive display of the kind of problem: feed water low pressure / permeator supply high pressure / permeate high conductivity
- Working hours display with maintenance block at "x" hours
- Flushing automatic management timed and at each cycle stop
- Automatic system start and stop
- Clean contact in exchange for external alarm signal
- Possibility of pre-treatment feedback (softener / carbon filter)
- Possibility of feeding an antiscalant metering pump (optional)



# RO40 - RO80 - RO120

## PRE-TREATMENT SECTION

Made with a 10" single DP filtration stage: CB EC carbon block cartridge with 5 micron filtration rate.

## PRESSURIZATION SECTION

Made up of a brass rotary vane electric pump with by-pass.

## PERMEATION SECTION

Made up of high-productivity and low-consumption reverse osmosis permeators (low energy).  
The membranes are closed in PRFV vessels capable of withstanding operating pressures of up to 21 bar.  
RO40: 1 membrane in 1 vessel  
RO80: 2 membranes in 2 vessels  
RO120: 3 membranes in 3 vessels

## HOSES

Feeding, high pressure and discharge hoses in PVC PN16; permeate hoses in material suitable for pressures until 10 bar.

## CONTROL AND HYDRAULIC CONTROL SECTION

- pressure gauge after the 5 micron filter, feed pressure at the membranes
- permeate, concentrate flow sight gauge
- fluxing, recirculation and discharge flow regulators
- protection pressure switch with system lock for low supply water level
- protection pressure switch with system lock for permeator supply high pressure
- membrane solenoid valve for system supply management
- membrane solenoid valves for module fluxing management
- conductivity probes for feed water and permeate

**FRAME** built in AISI 304 stainless steel section complete with brackets, vessel and hose fixing collars, valves and connections, leads for the various uses, electric control panel.

## OPTIONAL

- UV Lamp on permeate line.
- Antiscalant dosing system.
- START/STOP with pressure switch.
- Conductivity meter on permeate line.



## RO40 - RO80 - RO120

PERMEATE PRODUCTION 40-80-120 LITRES/HOUR											
CODE	MODEL	PERMEATE ± 10% (T = 20°C)	FINAL SALT REJECTION	MAXIMUM RECOVERY	TDS	SDI	TURBIDITY	HARDNESS	FREE CHLORINE IN	BACTERIA	DIMENSIONS (MAX SIZE)
EA0500003	RO40	40 l/h	≥ 95 %	27 (%)	≤ 1000 ppm	≤ 3	1 NTU MAX	≤ 1 °f	≤ 0,2 mg/l	ABSENT	660 x 400 x H1430 mm
EA0500004	RO80	80 l/h	≥ 95 %	45 (%)	≤ 1000 ppm	≤ 3	1 NTU MAX	≤ 1 °f	≤ 0,2 mg/l	ABSENT	660 x 400 x H1430 mm
EA0500005	RO120	120 l/h	≥ 95 %	58 (%)	≤ 1000 ppm	≤ 3	1 NTU MAX	≤ 1 °f	≤ 0,2 mg/l	ABSENT	660 x 400 x H1430 mm

## CHARACTERISTICS

Min/max feed water pressure	1,5 ÷ 4 bar	Total installed power	300 W
Min/max feed water temperature	5°C ÷ 35°C	Monophase electrical supply	230 V / 50 Hz
Feed water minimum flow rate	400 l/h	Supply connection	G 1/2" F
Min/max ambient temperature	5 °C ÷ 40 °C	Permeate / Discharge connections	G 1/2" F
Operating pressure	≤ 12 bar		



CONTROL PANEL

## ELECTRO-MECHANICAL CONTROL PANEL

- IP55 electrical box
- Built with microprocessors and fitted with a digital display
- Digital conductivity meter with LCD display to read the conductivity of the feed water and the water produced
- Alarm with visual descriptive display of the kind of problem: feed water low pressure / permeator supply high pressure / permeate high conductivity
- Working hours display with maintenance block at "x" hours
- Fluxing automatic management timed and at each cycle stop
- Storage tank level management
- Clean contact in exchange for external alarm signal
- Possibility of pre-treatment feedback (softener / carbon filter)
- Possibility of feeding an antiscalant metering pump (optional)



# RO200 - RO300 - RO400

## PRE-TREATMENT SECTION

Made with a 10" DUPLEX filtration group: first stage carbon cartridge; second stage cartridge with 5 micron filtration rate.

## PRESSURIZATION SECTION

Made up of a brass rotary vane electric pump with by-pass.

## PERMEATION SECTION

Made up of high-productivity and low-consumption reverse osmosis permeators (low energy).

The membranes are closed in PRFV vessels capable of withstanding operating pressures of up to 21 bar.

RO200: 2 membranes in 2 vessels

RO300: 3 membranes in 3 vessels

RO400: 4 membranes in 4 vessels

## HOSES

Feeding, high pressure and discharge hoses in PVC PN16; permeate hoses in material suitable for pressures until 10 bar.

## CONTROL AND HYDRAULIC CONTROL SECTION

- Pressure gauge after the 5 micron filter, feed pressure at the membranes, pressure after the modules
- Permeate, concentrate and recirculation flow sight gauge
- Fluxing, recirculation and discharge flow regulators
- Protection pressure switch with system lock for low supply water level
- Protection pressure switch with system lock for permeator supply high pressure
- Membrane solenoid valve for system supply management
- Membrane solenoid valves for module fluxing management
- Conductivity probes for feed water and permeate

**FRAME** built in AISI 304 stainless steel section complete with brackets, vessel and hose fixing collars, valves and connections, leads for the various uses, electric control panel.

## OPTIONAL

- UV Lamp on permeate line.
- Antiscalant dosing system.
- START/STOP with pressure switch.
- Conductivity meter on permeate line.
- Blending line for final conductivity regulation.



## RO200 - RO300 - RO400

PERMEATE PRODUCTION 40-80-120 LITRES/HOUR												
CODE	MODEL	PERMEATE ± 10% (T = 20°C)	FINAL SALT REJECTION	MAXIMUM RECOVERY	TDS	SDI	TURBIDITY	HARDNESS	FREE CHLORINE IN	BACTERIA	DIMENSIONS (MAX SIZE)	
EA0500006	RO200	180 l/h	≥ 95 %	30 ÷ 50 (%)	≤ 1000 ppm	≤ 3	1 NTU MAX	≤ 1 °f	≤ 0,2 mg/l	ABSENT	850 x 500 x H1700 mm	
EA0500007	RO300	270 l/h	≥ 95 %	50 ÷ 70 (%)	≤ 1000 ppm	≤ 3	1 NTU MAX	≤ 1 °f	≤ 0,2 mg/l	ABSENT	850 x 500 x H1700 mm	
EA0500011	RO400	360	≥ 95 %	50 ÷ 75 (%)	≤ 1000 ppm	≤ 3	1 NTU MAX	≤ 1 °f	≤ 0,2 mg/l	ABSENT	850 x 500 x H1700 mm	

## CHARACTERISTICS

Min/max feed water pressure.....	1,5 ÷ 4 bar	Total installed power.....	550 W
Min/max feed water temperature.....	5°C ÷ 35°C	Monophase electrical supply.....	230 V / 50 Hz
Feed water minimum flow rate.....	1200 l/h	Supply connection.....	G 3/4" F
Min/max ambient temperature.....	5 °C ÷ 40 °C	Permeate / Discharge connections.....	G 1/2" F
Operating pressure.....	≤ 10 bar		

## ELECTRO-MECHANICAL CONTROL PANEL

- IP55 electrical box
- Built with microprocessors and fitted with a digital display
- Digital conductivity meter with LCD display to read the conductivity of the feed water and the water produced
- Alarm with visual descriptive display of the kind of problem: feed water low pressure / permeator supply high pressure / permeate high conductivity
- Working hours display with maintenance block at "x" hours
- Fluxing automatic management timed and at each cycle stop
- Storage tank level management
- Clean contact in exchange for external alarm signal
- Possibility of pre-treatment feedback (softener / carbon filter)
- Possibility of feeding an antiscalant metering pump (optional)



CONTROL PANEL





# RO500 - RO750 - RO1000

## PRE-TREATMENT SECTION

Made with a 20" DUO filtration group: first stage carbon cartridge; second stage cartridge with 5 micron filtration rate.

## PRESSURIZATION SECTION

Made up of an AISI 304 stainless steel vertical multi-stage centrifugal electric pump.

## PERMEATION SECTION

Made up of high-productivity and low-consumption reverse osmosis permeators (low energy). The membranes are closed in PRFV vessels capable of withstanding operating pressures of up to 21 bar.

RO500: 2 membranes in 2 vessels

RO750: 3 membranes in 3 vessels

RO1000: 4 membranes in 4 vessels

## HOSES

Feeding, permeate, high pressure and discharge hoses in PVC PN16.

## CONTROL AND HYDRAULIC CONTROL SECTION

- Pressure gauge after the 5 micron filter, feed pressure at the membranes, pressure after the modules
- Permeate, concentrate and recirculation flow sight gauge
- Fluxing, recirculation and discharge flow regulators
- Protection pressure switch with system lock for low supply water level
- Protection pressure switch with system lock for permeator supply high pressure
- Membrane solenoid valve for system supply management
- Membrane solenoid valves for module fluxing management
- Conductivity probes for feed water and permeate

**FRAME** built in AISI 304 stainless steel section complete with brackets, vessel and hose fixing collars, valves and connections, leads for the various uses, electric control panel.

## OPTIONAL

- UV Lamp on permeate line.
- Antiscalant dosing system.
- START/STOP with pressure switch.
- Blending line for final conductivity regulation.
- XL Membranes for increased permeate production +20%.

## RO500 - RO750 - RO1000



### PERMEATE PRODUCTION 500-750-1000 LITRES/HOUR

CODE	MODEL	PERMEATE ± 10% (T = 20°C)	FINAL SALT REJECTION	MAXIMUM RECOVERY	TDS	SDI	TURBIDITY	HARDNESS	FREE CHLORINE IN	BACTERIA	DIMENSIONS (MAX SIZE)
EA0500008	RO500	500 l/h	≥ 95 %	30 ÷ 50 (%)	≤ 1000 ppm	≤ 3	1 NTU MAX	≤ 1 °f	≤ 0,2 mg/l	ABSENT	900 x 700 x H1540 mm
EA0500009	RO750	750 l/h	≥ 95 %	50 ÷ 70 (%)	≤ 1000 ppm	≤ 3	1 NTU MAX	≤ 1 °f	≤ 0,2 mg/l	ABSENT	900 x 700 x H1540 mm
EA0500010	RO1000	1000 l/h	≥ 95 %	50 ÷ 75 (%)	≤ 1000 ppm	≤ 3	1 NTU MAX	≤ 1 °f	≤ 0,2 mg/l	ABSENT	900 x 700 x H1540 mm

### CHARACTERISTICS

Min/max feed water pressure	1,5 ÷ 6 bar	Total installed power	1,5 kW
Min/max feed water temperature	10°C ÷ 35°C	Monophase electrical supply	380 V / 50 Hz
Feed water minimum flow rate	2000 l/h	Supply connection	G 3/4" F
Min/max ambient temperature	5 °C ÷ 40 °C	Permeate / Discharge connections	G 3/4" F
Operating pressure	≤ 10 bar		



CONTROL PANEL

### ELECTRO-MECHANICAL CONTROL PANEL

- IP55 electrical box
- Built with microprocessors and fitted with a digital display
- Digital conductivity meter with LCD display to read the conductivity of the feed water and the water produced
- Alarm with visual descriptive display of the kind of problem: feed water low pressure / permeator supply high pressure / permeate high conductivity / pump thermal protection operation
- Working hours display with maintenance block at "x" hours
- Fluxing automatic management timed and at each cycle stop
- Storage tank level management
- Clean contact in exchange for external alarm signal
- Possibility of pre-treatment feedback (softener / carbon filter)
- Possibility of feeding an antiscalant metering pump (optional)



# CHEMICALS



## FLOCON 135 - ANTISCALANT FOR REVERSE OSMOSIS SYSTEMS

Flocon 135 is an aqueous solution of a specialized phosphinocarboxylic acid, highly effective in controlling the deposition of inorganic scale forming salts on membrane surfaces.

Special features:

- Excellent control of carbonate and sulphate scales for cost effective operation
- Compatible with all major membranes
- International potable water approvals
- Dispersant
- Iron tolerant

Flocon 135 is not affected by chlorine or other oxidizing biocides under normal conditions of use; it may be used in membrane systems using chlorine and sodium metabisulphite.

Flocon 135 is an aqueous solution of an organic acid and as such is corrosive in its concentrated form. Corrosion resistant dosing equipment should therefore be used. Examples of suitable materials are 316L stainless steel, or plastics such as GRP, PVC and PE.

Flocon 135 is certified to ANSI / NSF Standard 60 for use in reverse osmosis systems producing potable water. Packaging: 25 kg (net weight) Plastic drums



## FLOCON 260 - ANTISCALANT AND ANTIFOULANT FOR REVERSE OSMOSIS SYSTEMS

Flocon 260 is an aqueous solution of a specialized polycarboxylic acid, highly effective in controlling the deposition of inorganic scale forming salts and particulate fouling on membrane surfaces.

Special features:

- Excellent control of carbonate scales, sulphate and fluoride for cost effective operation
- Effectively control both soluble and insoluble iron
- Effective against silica fouling
- Dispersant
- Compatible with all major membranes
- International potable water approvals

Flocon 260 is not affected by chlorine or other oxidising biocides under normal conditions of use; it may be used in membrane systems using chlorine and sodium metabisulphite. Flocon 260 is an aqueous solution of an organic acid and as such is corrosive in its concentrated form. Corrosion resistant dosing equipment should therefore be used. Examples of suitable materials are 316L stainless steel, or plastics such as GRP, PVC and PE.

Flocon 260 is certified to ANSI / NSF Standard 60 for use in reverse osmosis systems producing potable water. Packaging: 25 kg (net weight) Plastic drums



## FLOCON B38 - SANITISER FOR REVERSE OSMOSIS SYSTEMS

Flocon B38 is a fast acting high performance biocide for application as a sanitiser in reverse osmosis systems; it can also be added to the feedwater flow for predetermined times in between episodes of system sanitisation to control bio-film growth.

Special features:

- Fast acting
- Effective at low concentrations
- Effective against a broad spectrum of microorganisms
- Compatible with thin film composite membranes

Once or twice weekly treatments with Flocon B38 will effectively control bio-film growth. Packaging: 25 kg (net weight) Plastic drums



## FLOCLEAN MC3 - ACID MEMBRANE CLEANER

Floclean MC3 is a low pH formulation that has been designed specifically to remove metal hydroxides, calcium carbonate and other similar scales from polyamide and polysulfone membrane surfaces.

Special features:

- pH adjusted to 3.0+ 0.5
- Highly effective at ambient temperatures
- Contains no surfactants and is quickly rinsed away
- Contains organic acids, detergent builders and chelating agents

It can be used at temperatures from 15°C (60°F) up to the maximum recommended by the membrane manufacturer.

Packaging: 25 kg (net weight) Plastic drums



## FLOCLEAN MC11 - BASIC MEMBRANE CLEANER

Floclean MC11 is a high pH formulation that has been designed specifically to remove organics, silt and other particulate deposits from polyamide, polysulfone and thin film composite membrane surfaces.

Special features:

- pH adjusted to 10+ 0.5
- Highly effective at ambient temperatures
- Contains no surfactants and is quickly rinsed away
- Contains detergent builders, chelating agents

It can be used at temperatures from 15°C (60°F) up to the maximum recommended by the membrane manufacturer.

Packaging: 25 kg (net weight) Plastic drums



## ANHYDROUS SODIUM BISULPHITE - CHLORINE NEUTRALIZER FOR REVERSE OSMOSIS MEMBRANES

The chlorine neutralizer is a sodium bisulphite reducing formulation suitable to remove free and combined chlorine from supply water in reverse osmosis systems; as a matter of fact it is well known that in time the presence of free chlorine can ruin the membranes and affect the quality of the water produced by the osmosis systems. Thanks to the normal regular shutdowns, the neutralizer is suitable for maintaining the membranes of the reverse osmosis systems.

Packaging: 25 kg (net weight) bags





# DRINKING WATER STANDARDS

In this literature with "drinking water" it is intended the quality of water as for the **EU Council Directive 98/83/EC** concerning the quality of water for human consumption, as "...all water intended for drinking, cooking, food preparation and other domestic purposes..." and "...all water used in food-production undertaking for the manufacture, processing, preservation or marketing of products or substances intended for human consumption..." (Article 2).

By the EU Directive the following parameters should be not exceeded to comply with the definition of "drinking water".

WHO (World Health Organization) parameters are associated for confrontation of drinking water parameters worldwide.

## PART A

### MICROBIOLOGICAL PARAMETERS

PARAMETER	EU STANDARDS PARAMETRIC VALUE	WHO STANDARDS PARAMETRIC VALUE
<i>Escherichia coli</i> ( <i>E.coli</i> )	0/100 ml	-
Enterococci	0/100 ml	-

The following applies to water offered for sale in bottle or containers:

PARAMETER	PARAMETRIC VALUE	
<i>Escherichia coli</i> ( <i>E.coli</i> )	0/100 ml	-
Enterococci	0/100 ml	-
<i>Pseudomonas aeruginosa</i>	0/250 ml	-
Colony count 22°C	100/ml	-
Colony count 37°C	20/ml	-

## PART B

### CHEMICAL PARAMETERS

PARAMETER	UNIT	EU STANDARDS PARAMETRIC VALUE	WHO STANDARDS PARAMETRIC VALUE
Acrylamide (C <sub>3</sub> H <sub>5</sub> NO)	µg/l	ppb	0,1
Antimony (Sb)	µg/l	ppb	5
Arsenic (As)	µg/l	ppb	10
Benzene (C <sub>6</sub> H <sub>6</sub> )	µg/l	ppb	1
Benzo(a)pyrene (C <sub>20</sub> H <sub>12</sub> )	µg/l	ppb	0,01
Boron (B)	mg/l	ppm	1
Bromate (BrHO <sub>3</sub> <sup>-</sup> )	µg/l	ppb	10
Cadmium (Cd)	µg/l	ppb	5
Chromium (Cr)	µg/l	ppb	50
Copper (Cu)	mg/l	ppm	2
Cyanide (CN <sup>-</sup> )	µg/l	ppb	50
1,2-dichloroethane (ClCH <sub>2</sub> CH <sub>2</sub> Cl)	µg/l	ppb	3
Epichlorohydrin (C <sub>3</sub> H <sub>5</sub> ClO)	µg/l	ppb	0,1
Fluoride (F <sup>-</sup> )	mg/l	ppm	1,5
Lead (Pb)	µg/l	ppb	10
Mercury (Hg)	µg/l	ppb	1
Nickel (Ni)	µg/l	ppb	20
Nitrate (NO <sub>3</sub> <sup>-</sup> )	mg/l	ppm	50
Nitrite (NO <sub>2</sub> <sup>-</sup> )	mg/l	ppm	0,5
Pesticides	µg/l	ppb	0,1
Pesticides - Total	µg/l	ppb	0,5
Polycyclic aromatic hydrocarbons	µg/l	ppb	0,1
Selenium (Se)	µg/l	ppb	10
Tetrachloroethene (C <sub>2</sub> H <sub>2</sub> Cl <sub>4</sub> ) and Trichloroethene (C <sub>2</sub> H <sub>3</sub> Cl <sub>3</sub> )	µg/l	ppb	10
Trihalomethanes (CHX <sub>3</sub> ) - Total	µg/l	ppb	100
Vinyl chloride (C <sub>2</sub> H <sub>3</sub> Cl)	µg/l	ppb	0,5

The following applies as WHO standards only:

PARAMETER	UNIT	EU STANDARDS PARAMETRIC VALUE	WHO STANDARDS PARAMETRIC VALUE
Barium (Ba)	mg/l	ppm	-
Molibdenum (Mo)	mg/l	ppm	-
Nitrogen (N) - Total	mg/l	ppm	50

## PART C

### INDICATOR PARAMETERS

PARAMETER	UNIT	EU STANDARDS PARAMETRIC VALUE	WHO STANDARDS PARAMETRIC VALUE
Aluminium (Al)	µg/l	ppb	200
Ammonium (NH <sub>4</sub> <sup>+</sup> )	mg/l	ppm	0,5
Chloride (Cl <sup>-</sup> )	mg/l	ppm	250
<i>Clostridium perfringens</i> (including spores)			0/100 ml
Colour			Acceptable to consumers and no abnormal change
Conductivity	µS cm <sup>-1</sup> at 20°C		2500
Hydrogen ion concentration	pH units		>=6,5 and <=9,5
Iron (Fe)	µg/l	ppb	200
Manganese (Mn)	µg/l	ppb	50
Odour			Acceptable to consumers and no abnormal change
Oxidability	mg/l O <sub>2</sub>	ppm O <sub>2</sub>	5
Sulphate (SO <sub>4</sub> <sup>2-</sup> )	mg/l	ppm	250
Sodium (Na)	mg/l	ppm	200
Taste			Acceptable to consumers and no abnormal change
Colony count 22°C			No abnormal change
Coliform Bacteria			0/100 ml
Total Organic Carbon (TOC)			No abnormal change
Turbidity			Acceptable to consumers and no abnormal change

The following applies as WHO standards only:

PARAMETER	UNIT	EU STANDARDS PARAMETRIC VALUE	WHO STANDARDS PARAMETRIC VALUE
Chlorine dioxide (ClO <sub>2</sub> )	mg/l	ppm	-
			0,4

## RADIOACTIVITY

PARAMETER	UNIT	EU STANDARDS PARAMETRIC VALUE	WHO STANDARDS PARAMETRIC VALUE
Tritium (³H)	Bq/l	100	-
Total indicative dose	mSv/year	0,1	-

# GENERAL INFORMATION

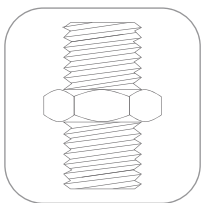

**BSP**  
parallel (cylindrical)  
ISO 228  
Fit to all housings  
except NPT  
marked housings

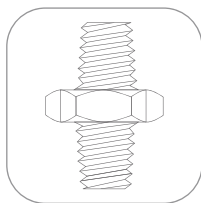

**NPT**  
tapered (conical)  
ANSI/ASME B1.20.1  
Use only  
with NPT  
marked housings

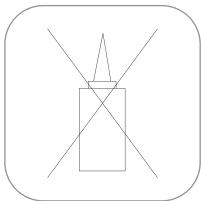

DO NOT USE  
liquid sealants or glues

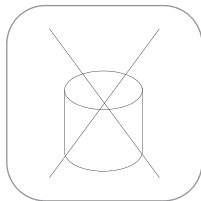

DO NOT USE  
green paste



DO NOT USE  
hemp

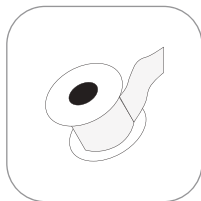

USE ONLY  
TEFLON® tape  
as a sealant

## Installation and maintenance

Read the instructions manual provided with products packages thoroughly and carefully and understand its contents before the installation.

Installation and maintenance of the products must be carried out in strict accordance with the instructions provided in the INSTALLATION INSTRUCTIONS manual, which is included in the housing package. Failure to comply with the instructions will render the warranty null and void.

In particular, it is forbidden to: exceed the operating conditions indicated, install the product in circuits liable to a "water hammer" effect without the use of a protection system for the filter, to filter liquids other than pH-neutral water, to filter compressed air or gas, to subject the filters to return hot water, to expose the filter to freezing or excessive heat.

## Installation layout

1. Municipal water mains | 2. Non-return valve | 3. Pressure reducer | 4. By-pass | 5. Anti-water hammer device (expansion vessel) - check from the table for the appropriate device volume (V) depending on piping diameter (Ø) | 6. Filtering or Dosing unit of any model | 7. Other utilities

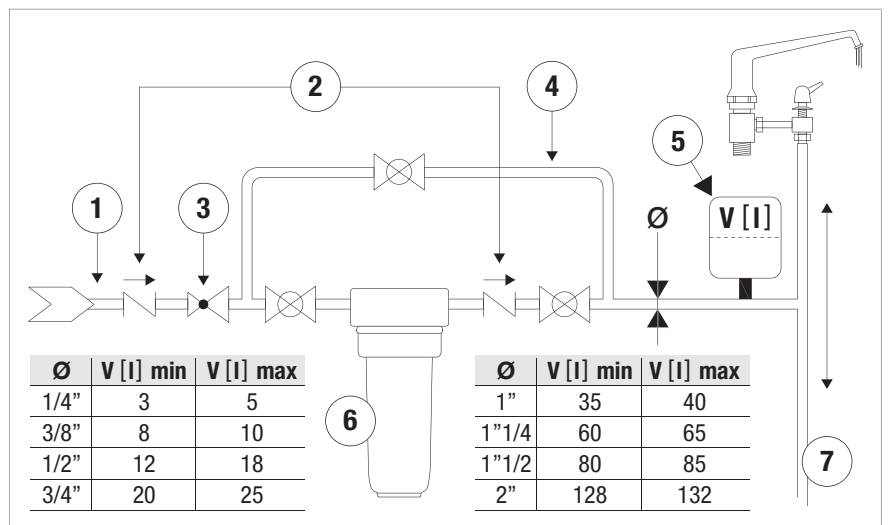

## Operating conditions

Housings and cartridges must be used within the limits of prescribed working conditions and exclusively for the applications indicated in the catalogue. Applications exceeding the limits prescribed or different from those indicated are prohibited.

### Important

Use only original Atlas Filtri cartridges, replacement and spare parts. The warranty is null and void if non original replacements are used.

### Remark

Use products in compliance with the local laws in force for the filtration and treatment of drinking water. Atlas Filtri declines all responsibilities in the case of non-compliance with the laws in force on the use of its products for the filtration and treatment of drinking water.

### Caution

All types of products must be disposed of in accordance with the laws in force.



**ATLAS FILTRI s.r.l.**

Headquarter: via Pierobon, 32

Production site: via del Santo, 227

I-35010 Limena, Italy

Tel. +39.049.76.90.55 Fax +39.049.76.99.94

**[www.atlasfiltri.com](http://www.atlasfiltri.com)**

**ATLAS FILTRI, DEPURAL and SANIC** are registered trade marks of ATLAS FILTRI srl.  
Unauthorized use of the registered trade mark is strictly forbidden and legally persecuted.  
Images and texts are property of ATLAS FILTRI srl, which reserves the rights to change products design and specification without prior notice.